

Installing the Enphase IQ Commercial Envoy

To install the Enphase IQ Commercial Envoy™, read and follow all warnings and instructions in this Guide and in the *Enphase IQ Commercial Envoy Installation and Operation Manual* at: enphase.com/support. Safety warnings are listed on the back of this guide.

IMPORTANT: Enphase IQ Commercial Envoy, IQ Envoy, and IQ Series Micros do not communicate with, and should not be used with, previous generation Enphase Microinverters and Envoys. Always use IQ Series Microinverters with an IQ Commercial Envoy or an IQ Envoy.

How It Works

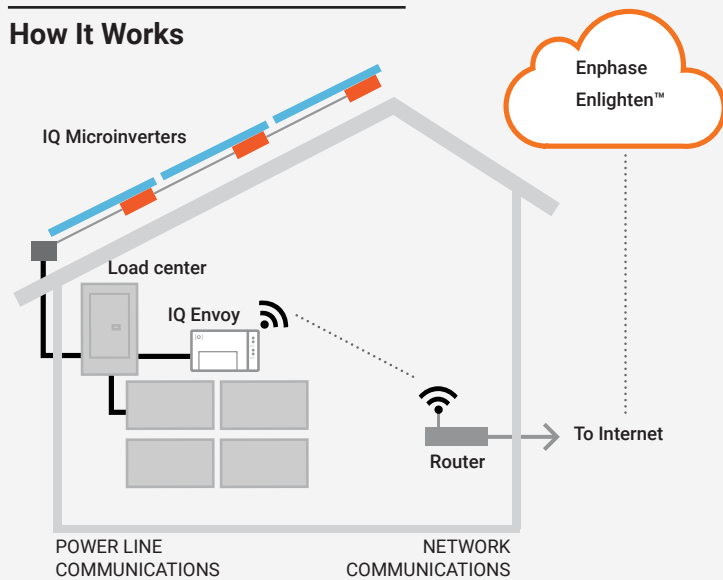

IQ Commercial Envoy Display and Controls

Track system installation progress with the **Enphase Installer Toolkit™** mobile app. The LEDs on the IQ Commercial Envoy are solid green when a function is enabled or performing as expected, flashing when an operation is in progress, or solid amber when troubleshooting with Installer Toolkit is required. For a legend of all LED states, see *Troubleshooting* **a**.

- Network Communications LED**
Green when IQ Commercial Envoy is connected to Enlighten™.
- AP Mode LED**
Green when Envoy's AP Wi-Fi network is available.
- AP Mode Button**
Press to enable Envoy's AP Mode for connecting with a mobile device. Hold for 5 seconds to start WPS connection to a router.
- Power Production LED**
Green when microinverters are producing power.
- Device Communications LED**
Green when devices are communicating with IQ Commercial Envoy.
- Device Scan Button**
Press to start/stop 15 minute scan for devices over the power line.



Enphase Installer Toolkit mobile app

PREPARATION

- A) Download the Enphase Installer Toolkit mobile app and open it to log in to your Enlighten account. With this app, you can connect to the IQ Commercial Envoy to track system installation progress. To download, go to enphase.com/toolkit or scan the QR code at right.
- B) Download the latest version of the software to your mobile device. To do so, go to the **Envoy Resources** screen in the Installer Toolkit **Settings**.
- C) Check the box for the following items:
 - Enphase IQ Commercial Envoy (look for the IQ logo)
 - Three solid-core **production** metering current transformers (CTs)
 - Length of DIN rail for mounting
 - *Enphase IQ Commercial Envoy Quick Install Guide* (this document)
- D) If you plan to do consumption metering, make sure you have three split-core consumption metering CTs (order CT-200-SPLIT).



Note: The consumption CTs monitor up to 200A of consumption current and fit conductors with a maximum outside diameter of 0.84" (21.33mm). You can use up to two parallel connected consumption CTs for monitoring up to two conductors. For conductors or bussing greater than 200A, the consumption CTs shall not be installed or enabled.

- E) Check that there is enough space in the load center to install CTs. Do not install CTs where they exceed 75% of the wiring space of any cross-sectional area within the load center.
- F) Install the IQ Commercial Envoy in a NRTL Certified, NEMA type 3R (or better) enclosure with conduit attachment when installing outdoors. Do not drill holes on the top of the enclosure or anywhere that allows moisture ingress. Metallic enclosures may impair Wi-Fi signal strength. Use an appropriately rated enclosure if installing indoors.
- G) Decide how to connect the IQ Commercial Envoy to the Internet: Use Wi-Fi, an Enphase Mobile Connect modem, or Ethernet. Then, make sure you have the following optional items, if needed:
 - Enphase Mobile Connect modem [order CELLMODEM-01 (3G) or CELLMODEM-03 (4G)]
 - Ethernet over power line communication (PLC) bridge with Ethernet cables (order EPLC-01). You must use a ferrite bead on the Ethernet cable (we recommend Fair-Rite 0431167281).
 - Ethernet cable [802.3, Cat5E or Cat6, unshielded twisted pair (UTP)]. Do not use shielded twisted pair (STP) cable. You must use a ferrite bead on the Ethernet cable (we recommend Fair-Rite 0431167281).
- H) Create a paper installation map to record device serial numbers and positions in the array. You will scan this map later using Installer Toolkit and your mobile device.
 - As you do with the microinverters, peel the removable label from the bottom of the IQ Commercial Envoy and affix it to the paper installation map.
 - Always keep a copy of the installation map for your records.
- I) **Note that installation of the IQ Commercial Envoy has two parts. To ensure successful device detection, complete Part 2 after installing any Enphase IQ Microinverters.**

Note: If needed, you can find an installation map at the back of the Enphase IQ Microinverter Quick Install Guide.

INSTALLATION – Part 1

It is a best practice to complete Installation Part 1 before installing Enphase Microinverters.

For steps 2 and 3, refer to the wiring diagram on the next page.

1 Choose a location for the IQ Commercial Envoy



WARNING: Risk of equipment damage. When installing the IQ Envoy in an enclosure, choose area for installation where ambient temperature does not exceed 46° C (115° F).

- A) Install the IQ Commercial Envoy near the main load center or PCC (point of common coupling) and consider the length of the production CT leads (5 feet) when choosing the location. Do not extend the leads of the production CTs.
- B) Install the IQ Commercial Envoy in a protected dry space in an NRTL Certified, NEMA type 3R (or better) enclosure with conduit attachment. Use an appropriately rated enclosure if hard wiring the IQ Commercial Envoy indoors.
NOTE: Metallic enclosures may impair Wi-Fi signal strength.
- C) Mount the Envoy horizontally using the included DIN rail.

2 Wire the IQ Commercial Envoy for Power and Metering

The IQ Envoy uses terminal blocks for power and metering connections. Refer to the wiring diagram on the following page when performing this step.

You must install three solid-core current transformers (CTs) for production metering. Consumption monitoring is optional and requires that you order and install three additional split-core CTs. Use a protected route in conduit for the CT wires from the main load center to the IQ Commercial Envoy. The consumption CT leads are 13 feet long. If you need to extend the leads, refer to the *Enphase IQ Commercial Envoy Installation and Operation Manual* at: enphase.com/support. Do not extend the leads of the production CT.



DANGER! Risk of electric shock. Always de-energize circuits before wiring for power and CTs.

DANGER! Risk of electrocution! Do not install CTs when current is flowing in the sensed circuit. Always install CT wires in the terminal blocks before energizing the sensed circuit.

Note: When installing CTs, it is important to match CT and sense voltage phases. Be sure to consistently identify the three AC lines at three points: the main load center feed, the Envoy, and the solar production circuit breaker. Wire colors (typically black, red, and blue) may not always consistently identify L1, L2, and L3. If in doubt, use a multimeter to check.

Note: Because of variance in load center design and main power feed, there may not always be enough space to install consumption metering CTs. See our technical brief, *Assessing a Site for Installing Consumption CTs*, at enphase.com/support.

- A) Before running the CT wires through conduit, use colored tape to mark each of the CTs and the free ends of its wires, marking each with a different color. You can run multiple CT wires through a single conduit.
- B) Wire the IQ Commercial Envoy for **power**
 - Use a three-pole circuit breaker of up to 20 A (maximum) for the supply wiring.
 - Make sure supply wiring is 14 AWG or larger copper rated at 75 degrees C or better.
 - Use a screwdriver to loosen the screw on the terminal block door and open the door.
 - Flip open the terminal block door and wire the line and neutral conductors as shown: Connect Line 1 to L1, Line 2 to L2, Line 3 to L3, and Neutral to N. Tighten to 10.5 in-lbs (1.2 N m).

Note: Only run active conductors of the same phase through each CT. Each CT can monitor multiple active conductors.

- C) Install the **production** CTs on active phases as required:
 - Locate the arrow on the CT label.
 - **To monitor production on Line 1:**
 - Connect the white wire to the white "P1" terminal and the blue wire to the blue "P1" terminal.
 - Pass Line 1 of the solar production circuit through the CT with the arrow pointing toward the load (away from the solar array).
 - **To monitor production on Line 2:**
 - Connect the white wire to the white "P2" terminal and the blue wire to the blue "P2" terminal.
 - Pass Line 2 of the solar production circuit through the CT with the arrow pointing toward the load (away from the solar array).
 - **To monitor production on Line 3:**
 - Connect the white wire to the white "P3" terminal and the blue wire to the blue "P3" terminal.
 - Pass Line 3 of the solar production circuit through the CT with the arrow pointing toward the load (away from the solar array).
 - **Tighten all connections to 5 in-lbs (0.6 N m).**
- D) Install the **consumption** CTs on active phases as required:
 - Locate the arrow on the CT label.
 - Make sure that the AC mains wire(s) are de-energized until you have secured the CT wires in the terminal blocks.
To monitor consumption on Line 1:
 - Connect the white wire to the white "C1" and the blue wire to the blue "C1" terminal.
 - Clamp the CT on the main supply Line 1. When the consumption CT is on Line 1 conductor, the arrow must point toward the load (away from the grid).
 - **To monitor consumption on Line 2:**
 - Connect the white wire to the white "C2" terminal and the blue wire to the blue "C2" terminal.
 - Clamp the CT on the main supply Line 2. When the consumption CT is on Line 2 conductor, the arrow must point toward the load (away from the grid).
 - **To monitor consumption on Line 3:**
 - Connect the white wire to the white "C3" terminal and the blue wire to the blue "C3" terminal.
 - Clamp the CT on the main supply Line 3. When the consumption CT is on Line 3 conductor, the arrow must point toward the load (away from the grid).
 - **Tighten all connections to 5 in-lbs (0.6 N m).**

3 Energize and Update the IQ Commercial Envoy

- A) Close the terminal block door, and secure it with the screw.
- B) Turn on the circuit feeding the IQ Commercial Envoy.
- C) On the Envoy, if the AP Mode LED is not lit, press the AP Mode button.
- D) On your mobile device, go to Settings and join the Wi-Fi network "Envoy_nnnnnn" (where "nnnnnn" represents the final six digits of the IQ Commercial Envoy serial number).
- E) The Installer Toolkit app informs you if the Envoy software is not current by displaying the Envoy Software Update message. If this message displays, follow the on-screen instructions to update the Envoy.
- F) For a short period (5-10 minutes), you must keep your mobile device near the Envoy. Follow the on-screen instructions while the update takes place.

The update may take up to 20 minutes. The Envoy reboots several times during the update and the LEDs light up in varied sequences until the



WARNING: Do not remove power from the IQ Commercial Envoy during the software update.

update is complete.

All four LEDs flash amber during boot up (approximately 3 minutes). When boot up is complete, the Device Communications LED  lights solid amber, indicating that devices are not yet detected.

IQ COMMERCIAL ENVOY WIRING

IQ Envoy Terminal Block

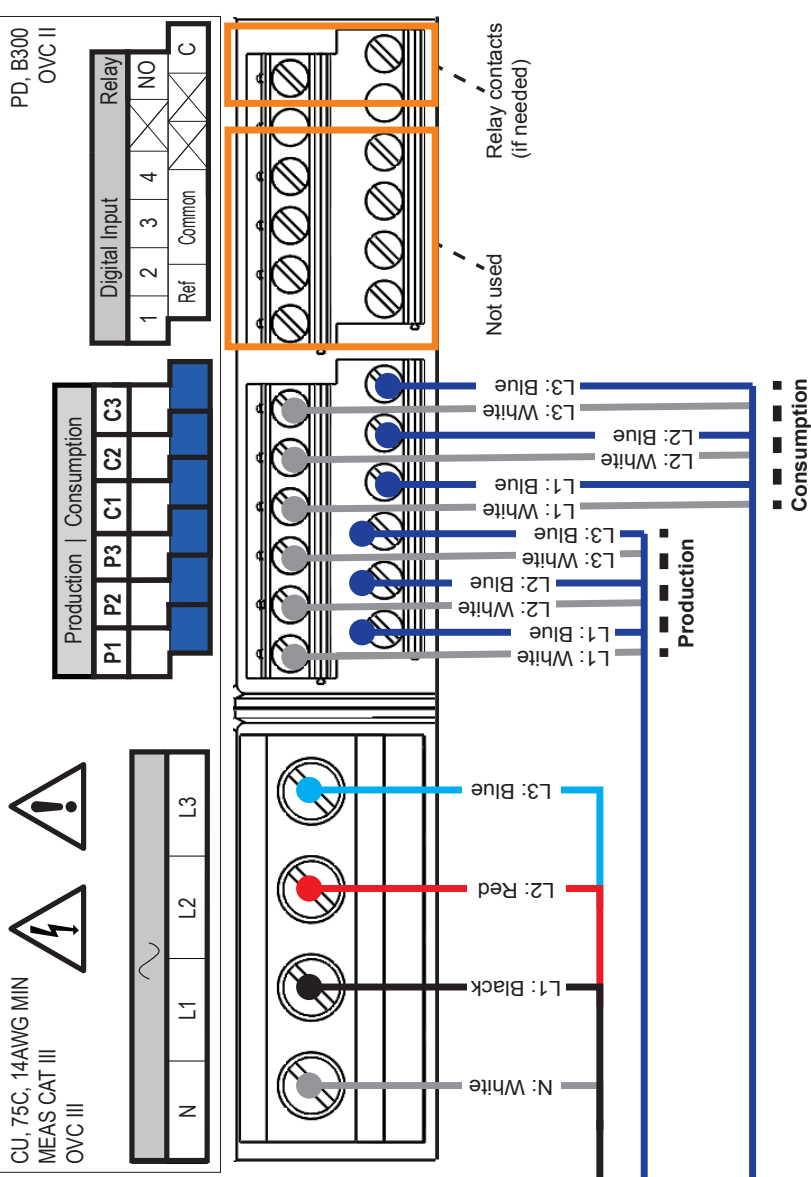

To Solar Subpanel

Load Center

To Grid

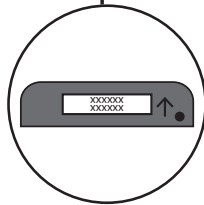

Production CT.
Solid Core.

The arrow must point toward the load — away from the solar array.

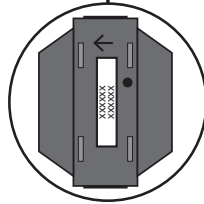

Consumption CT.
Split Core.

The arrows must point toward the load — away from the grid.

INSTALLATION — Part 2

Once the update is finished and the PV system is installed, the Envoy is ready for **Installation Part 2**. You must complete Installation Part 2 after installing the PV system.

4 Detect Devices

Use one of the following methods to detect devices (Enphase Microinverters).

Method A // Provision devices with Installer Toolkit

Use the Installer Toolkit mobile app to configure the IQ Commercial Envoy with the serial numbers of the installed devices.

- Launch the Installer Toolkit app and tap **View Systems**.
- Select the system you are working with, or tap **[+]** to add a new system.
- Connect to the IQ Commercial Envoy with your mobile device (smart phone or tablet) to the IQ Commercial Envoy. The AP Mode LED  lights solid green when the network is available.
 - On the Envoy, if the AP Mode LED is not lit, press the AP Mode button.
 - On your mobile device, go to Settings and join the Wi-Fi network "Envoy_nnnnnn" (where "nnnnnn" represents the final six digits of the IQ Commercial Envoy serial number).
- If the serial number for the Envoy you are installing is not displayed on the System Overview screen, tap the **[+]** next to the word "Envoys". When the app displays the serial number of the Envoy, tap it to add it to the system.
- Following the on-screen instructions to create the arrays and scan the serial numbers from the installation map.
- Tap the **Connect** button. This provisions the scanned devices on the Envoy.
- When prompted, confirm the number of devices that you installed.
- If your system requires a region-specific grid profile, select and apply a grid profile to the devices. (Systems in Hawaii require you to set a profile.)

The Device Communications LED  lights solid green if all the provisioned devices are communicating or solid amber if any devices are not communicating.

Method B // Discover devices with Installer Toolkit

Use the Installer Toolkit mobile app to set the number of devices the IQ Commercial Envoy should search for on the power line.

- Connect to the IQ Commercial Envoy with your mobile device (smart phone or tablet) to the IQ Commercial Envoy. The AP Mode LED  lights solid green when the network is available.
 - On the Envoy, if the AP Mode LED is not lit, press the AP Mode button.
 - On your mobile device, go to Settings and join the Wi-Fi network "Envoy_nnnnnn" (where "nnnnnn" represents the final six digits of the IQ Commercial Envoy serial number).
- Launch Installer Toolkit and tap **Connect to an Envoy**.
- When prompted, enter the number of devices that you installed.
- If your system requires a region-specific grid profile, select and apply a grid profile to the devices. (Systems in Hawaii require you to set a profile.)
- When prompted to start a device scan, tap **OK**.

The Device Communications LED  flashes green while scanning, solid green when all the devices you installed are communicating, or solid amber if any devices are not communicating.



With both methods

If the Device Communications LED remains solid amber, see *Troubleshooting* .

5 Verify Configuration and Enable the Meters

While still connected to the IQ Commercial Envoy with Installer Toolkit, check the Overview screen for the following:

- Confirm that the expected number of devices are detected and communicating.
- Check that the new profile is set on all the devices. Setting the profile may take up to 5 minutes for a typical system.
- Tap the **Meters** button.
- Tap **Production Meter** and follow the on-screen instructions to enable the Production Meter.
- If you installed consumption metering CT(s), tap **Consumption Meter** and follow the on-screen instructions to enable the Consumption Meter.
- Return to the **Overview** screen and verify the meter reading(s).

If you used Installer Toolkit to detect devices, the Power Production LED  lights solid green when all expected microinverters are producing power. If you did not use Installer Toolkit, it lights solid green if all communicating microinverters are producing power. It flashes green when devices are upgrading. Check Installer Toolkit for production status details. If the Power Production LED remains solid amber, see *Troubleshooting* .

6 Connect to Enlighten

This section describes using the IQ Commercial Envoy integrated Wi-Fi or the Mobile Connect modem. For information about using Ethernet and/or PLC bridges, refer to the *Enphase IQ Commercial Envoy Installation and Operation Manual* at: enphase.com/support.

Method A // Integrated Wi-Fi

Requires a wireless router with an Internet connection.

- On the Envoy, verify that no Ethernet cable is plugged into the RJ45 port.
- If the router supports WPS, press and hold the WPS button on the wireless router for a few seconds. On most routers, a WPS indicator begins flashing.
- If you are using the Installer Toolkit mobile app, tap the **Network** button, tap **Wi-Fi**, and then tap your network from the list of available networks. If the wireless router does not support WPS, you may be prompted to enter a password.

The Network Communications LED  begins flashing green.

Within three minutes the Network Communications LED lights solid green, indicating a successful connection to Enlighten. If the Network Communications LED remains off or lights solid amber, see *Troubleshooting* .

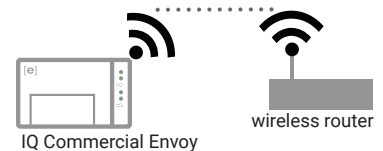

Method B // Enphase Mobile Connect Modem

[Order CELLMODEM-01 (3G) or CELLMODEM-03 (4G) separately]

- Connect the antenna(s) to the connector(s) and mount the modem as described in the *Enphase Mobile Connect Installation Guide*.
- First, connect the USB cable to the IQ Commercial Envoy and then connect the mini-USB connector to the modem. If receiving power from the IQ Commercial Envoy, the modem power LED lights.

Within three minutes the Network Communications LED lights solid green, indicating a successful connection to Enlighten. If the Network Communications LED remains off or lights solid amber, see *Troubleshooting* in the *Enphase Mobile Connect Installation Guide*.

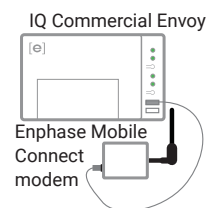

7 Send System Summary Report

When you have completed your system setup, you can generate and email a summary report.

- From Installer Toolkit, tap **Done** in the upper-right corner of the screen to disconnect from the Envoy. Installer Toolkit will ask if you want to view a summary report.
- Tap **View Report**. The report displays IQ Envoy and system information with a list of device serial numbers, their last power reports, and information about the grid profile applied to the devices.
- Tap  to email the report as needed as a record of successful system installation and for evidence of grid profile settings.

8 Activate Monitoring

Register the IQ Envoy in Enlighten (enlighten.enphaseenergy.com).

Method A // If the IQ Envoy is associated with a system in Installer Toolkit

- On your mobile device, go to Settings and disconnect from the Envoy's Wi-Fi network.
- Return to the Installer Toolkit app and tap the **Sync** button on the System Overview screen.

C) When you have access to a computer with Internet access, log in to Enlighten and select the system name from the Activation List on the dashboard.

D) From the activation form, open Array Builder.

If you used Installer Toolkit to build arrays and scan device serial numbers, the array(s) are built—make any necessary adjustments in Array Builder.





If you did NOT use Installer Toolkit to build arrays and scan device serial numbers, create the virtual array in Array Builder using the installation map as your reference. (You may need to wait if the devices have not yet reported to Enlighten.)

Method B // If the IQ Commercial Envoy is NOT associated with a system in Installer Toolkit

- Log into Enlighten and click **Add a New System** from the dashboard.
- Enter the System, Installer, Owner, and Location information.
- Enter the IQ Commercial Envoy serial number.
- Click **Save** to submit the form.
- After the devices have reported to Enlighten, open Array Builder from the activation form, and create the virtual array, using the installation map as your reference.

TROUBLESHOOTING

a LED overview

LED	State	Description
All	Flashing amber in unison	The IQ Commercial Envoy is booting up
	Flashing green sequentially	Software upgrade in progress
 Network communications	Solid green	Communicating with Enlighten
	Flashing green	WPS connection in progress or the IQ Envoy is attempting to connect to Enlighten
	Solid amber	Local network connection only
 AP mode	Off	No network connection
	Solid green	AP mode enabled: IQ Commercial Envoy Wi-Fi network available
 Power production	Off	AP mode disabled: IQ Envoy Wi-Fi network unavailable
	Solid green	All communicating microinverters are producing
	Flashing green	Microinverter upgrade in progress
	Solid Amber	At least one microinverter is not producing
 Device communications	Off	Microinverters are not producing or communicating (low light or night time)
	Solid Green	All devices are communicating
	Flashing Green	Device scan in progress
	Solid Amber	At least one device is not communicating
	Solid Amber	At least one device is not communicating
	Off	Devices are not communicating (low light or night time)

b Device detection issues

If the Device Communications LED  lights solid amber, it may be a result of low light levels. If there isn't enough sunlight to power up the microinverters, they can't communicate with the Envoy.

If there is sufficient daylight for the microinverters to power up, the issue may be that the IQ Commercial Envoy is having difficulty communicating over the power lines. To troubleshoot this issue:

- Check the Installer Toolkit mobile app to see which devices are not communicating.
- Check that the circuit breaker(s) for the PV array are in the "ON" position.
- Verify that the PV modules are connected to the microinverters.
- Verify the PV module DC voltage is within the allowable range for the microinverter.

c Power production issues

If the Power Production LED  lights solid amber, check the Installer Toolkit mobile app to see which microinverters are not producing:

- If none of the microinverters are producing power, there may be a grid or wiring issue. First, verify that there is proper input voltage and frequency from the grid. Next, check the breaker and wiring, starting at the load center.
- If all the non-productive microinverters are on the same branch, check the breaker and wiring starting at the junction box for the affected branch.
- If only one or scattered microinverters are not producing power, first check to see that the AC connectors are fully connected. Next, check that each module is providing the required startup voltage for the microinverter (22V). A PV module that is failing or that is undersized may not generate enough power for AC conversion.

d Internet connection issues

If you are using Wi-Fi and the Network Communications LED  remains off:

- The WPS connection window may have timed out. Retry the connection steps.
- Make sure that the broadband router is operational by checking that other devices at the site can access the network.
- Be aware that metal enclosures or obstructions impede wireless communication.
- If you cannot see your router or access point in the list on the Envoy, or cannot maintain a connection, it may be necessary to add a wireless repeater to extend the network range.

If you are using Wi-Fi and the Network Communications LED lights solid amber, make sure that the broadband router is connected to the Internet by checking that other devices at the site can access the Internet.



If you are using the Enphase Mobile Connect modem and the Network Communications LED remains off or lights solid amber, see Troubleshooting in the Enphase Mobile Connect Installation Guide.

For any connection method, you can troubleshoot network issues with the Installer Toolkit mobile app by tapping the **Network** button, then **Diagnostic Tools**.

If you replace the broadband router, configure the IQ Commercial Envoy Wi-Fi settings for the new Wireless Network Name (SSID) and password. Or use the WPS function described in step 6.

SAFETY

Safety and Advisory Symbols

	DANGER: This indicates a hazardous situation, which if not avoided, will result in death or serious injury.
	WARNING: This indicates a situation where failure to follow instructions may be a safety hazard or cause equipment malfunction. Use extreme caution and follow instructions carefully.
	NOTE: This indicates information particularly important for optimal system operation. Follow instructions carefully.

Safety Instructions

	DANGER: Risk of electric shock. Risk of fire. Do not attempt to repair the IQ Commercial Envoy; it contains no user-serviceable parts. Tampering with or opening the IQ Commercial Envoy will void the warranty. Warranty void if cover removed. If the IQ Commercial Envoy fails, contact Enphase Customer Support for assistance (enphase.com/en-us/support/).
	DANGER: Risk of electric shock. Always open or disconnect circuit from power-distribution system (or service) of building before installing or servicing current transformers (CTs).
	DANGER: Risk of electrocution! Do not install CTs when current flowing in the sensed circuit. Always install CT wires in the terminal blocks before energizing the sensed circuit.
	DANGER: Risk of electric shock. Do not use Enphase equipment in a manner not specified by the manufacturer. Doing so may cause death or injury to persons, or damage to equipment.
	DANGER: Risk of electric shock. Be aware that installation of this equipment includes risk of electric shock. Always de-energize the load center before beginning wiring.
	DANGER: Risk of electric shock. Risk of fire. Only qualified personnel should troubleshoot, install, or replace the IQ Commercial Envoy.
	DANGER: Risk of electric shock. Risk of fire. Do not wire unused terminals or terminal blocks on the IQ Commercial Envoy.
	WARNING: Before installing or using the IQ Commercial Envoy, read all instructions and cautionary markings in the technical description and on the IQ Commercial Envoy.
	WARNING: Risk of equipment damage. If installing the IQ Commercial Envoy in an enclosure, choose area for installation where ambient temperature does not exceed 46° C (115° F).
	NOTE: Do not install the CTs in a panel where they exceed 75% of the wiring space of any cross-sectional area within the panel, or refer to local standards for guidance.
	NOTE: Do not install CTs in an area where they will block ventilation openings, or in area of breaker arc venting.
	NOTE: The CTs are not suitable for Class 2 wiring methods and not intended for connection to Class 2 equipment.
	NOTE: Secure CT and route conductors so that they do not directly contact live terminals or bus.
	NOTE: Perform all electrical installations in accordance with all national and local electrical codes.
	NOTE: To ensure optimal reliability and to meet warranty requirements, the Enphase IQ Commercial Envoy must be installed according to the instructions in this guide.

FCC Statement: This equipment has been tested and found to comply with the limits for a Class B digital device, pursuant to part 15 of the FCC Rules. These limits are designed to provide reasonable protection against harmful interference in a residential installation. This equipment generates, uses and can radiate radio frequency energy and, if not installed and used in accordance with the instructions, may cause harmful interference to radio communications. However, there is no guarantee that interference will not occur in a particular installation. If this equipment does cause harmful interference to radio or television reception, which can be determined by turning the equipment off and on, you are encouraged to try to correct the interference by one or more of the following measures:

- Reorient or relocate the receiving antenna.
- Increase the separation between the equipment and the receiver.
- Connect the equipment into an outlet on a circuit different from that to which the receiver is connected.
- Consult the dealer or an experienced radio/TV technician for help.

Changes or modifications not expressly approved by the party responsible for compliance may void the user's authority to operate the equipment.

This Class B digital apparatus complies with Industry Canada ICES-003.



148-00185-01