



ProHarvest PHXL480-10k Grid-Interactive Inverter Owner's Manual



About OutBack Power

OutBack Power is a leader in advanced energy conversion technology. OutBack products include true sine wave inverter/chargers, maximum power point tracking charge controllers, and system communication components, as well as circuit breakers, batteries, accessories, and assembled systems.

Contact Information

Address: Corporate Headquarters
17825 – 59th Avenue N.E.
Suite B
Arlington, WA 98223 USA

Website: <http://www.outbackpower.com>

Disclaimer

UNLESS SPECIFICALLY AGREED TO IN WRITING, OUTBACK POWER:

(a) MAKES NO WARRANTY AS TO THE ACCURACY, SUFFICIENCY OR SUITABILITY OF ANY TECHNICAL OR OTHER INFORMATION PROVIDED IN ITS MANUALS OR OTHER DOCUMENTATION.

(b) ASSUMES NO RESPONSIBILITY OR LIABILITY FOR LOSS OR DAMAGE, WHETHER DIRECT, INDIRECT, CONSEQUENTIAL OR INCIDENTAL, WHICH MIGHT ARISE OUT OF THE USE OF SUCH INFORMATION. THE USE OF ANY SUCH INFORMATION WILL BE ENTIRELY AT THE USER'S RISK.

OutBack Power cannot be responsible for system failure, damages, or injury resulting from improper installation of their products.

Notice of Copyright

ProHarvest PHXL480-10k Grid-Interactive Inverter Owner's Manual © 2019 by OutBack Power.
All Rights Reserved.

Trademarks

ProHarvest, the ProHarvest logo, OutBack Power, and the phrase "ProHarvest by OutBack Power" are trademarks owned and used by OutBack Power, an EnerSys company. These trademarks may be registered in the United States and other countries.

Date and Revision

March 2019, Revision A

Part Number

900-0243-01-00 Rev A



Table of Contents

Symbols Used.....	5
Product Labels.....	5
General Safety.....	5
Introduction	7
Audience.....	7
Features.....	7
Components and Accessories.....	7
System Overview.....	8
Planning	9
Design Guidelines.....	9
DC Stacking Ratio	9
Location	9
Installation	11
Buttons and Indicators	11
Connection Outline	13
Connection Order	13
Connection Steps.....	14
A. Grounding	14
B. AC Wiring.....	15
C. PV Module Connection	17
D. AC Power-Up	18
E. Gateway Connection.....	19
F. Unlocking and Locking Inverters.....	21
Disconnection.....	21
Gateway	23
Gateway Operation.....	23
Touch Screen	23
Menu Map	24
External Access	25
Array Tab (Array Summary Screen)	26
Inverters Tab.....	27
Gateway Tab.....	30
Accessing the Gateway Online.....	31
Gateway Access Inside a Local Network.....	32
Webpage Menu Map	33
Gateway Access Outside a Local Network	34
LAN-side Configuration	34
WAN-side Configuration.....	35
Utility Protective Functions (Webpage only)	36
Other Gateway Features	37
Troubleshooting.....	39
General Troubleshooting	39
Specifications	45
Specification Tables.....	45
Regulatory Specifications	47
Footprints.....	48

List of Tables





Table 1	System Ordering and Part Numbers	8
Table 2	Inverter Commands (Button)	11
Table 3	Inverter States (Button)	12
Table 4	Port Numbering Assignments.....	35
Table 5	Inverter States (Button)	39
Table 6	Symptoms and Corresponding Issues	41
Table 8	General Specifications	45
Table 9	Power System Specifications	45
Table 10	Gateway Specifications	46
Table 11	Operating Parameters	46

Important Safety Instructions

READ AND SAVE THESE INSTRUCTIONS!



This manual contains important safety instructions for the ProHarvest inverter system. The inverter system is designed according to North America safety requirements. As with any electrical equipment, certain precautions must be observed when installing this equipment. To reduce the risk of personal injury and to ensure safe installation and operation, carefully read and follow all instructions, cautions and warnings in this manual.

Symbols Used



	WARNING: Hazard to Human Life This type of notation indicates that the hazard could be harmful to human life.
	CAUTION: Hazard to Equipment This type of notation indicates that the hazard may cause damage to the equipment.
	IMPORTANT: This type of notation indicates that the information provided is important to the installation, operation and/or maintenance of the equipment. Failure to follow the recommendations in such a notation could result in voiding the equipment warranty.
	NOTE: This type of notation indicates that the information provided is important to understanding the operation and limits of the equipment. Failure to follow the recommendations in such a notation could result in improper or failed operation.

Product Labels







The following symbols are used as markings on this product with the following explanations:

	WARNING: Dangerous Voltage This product incorporates high voltages. All handling of and operation of this product should closely follow the instructions included.
	WARNING: Beware of Hot Surface This product may become hot during operation. Contact should be avoided.

General Safety

	WARNING: Limitations on Use This equipment is NOT intended for use with life support equipment or other medical equipment or devices.
	WARNING: Reduced Protection If this product is used in a manner not specified by ProHarvest product literature, the product's internal safety protection may be impaired.

Important Safety Instructions

	<p>WARNING: Shock Hazard</p> <ul style="list-style-type: none"> ❖ PV arrays produce voltages that can present an electrical shock hazard. Wiring of PV arrays should be performed by qualified personnel following all manufacturer's guidelines. ❖ Before disconnecting DC cables, use a current clamp meter to measure the presence of current. If current is present, cover the portion of the array affected (following NEC 690.18).
	<p>WARNING: Burn Hazard</p> <p>The body of the inverter acts as a heat sink. Under normal operating conditions, the temperature of the exterior of the enclosure can reach more than 15°C above ambient. Under extreme conditions, the exterior of the enclosures can reach a temperature of 80°C. To reduce risk of burns, use caution when working with the inverter system.</p>
	<p>CAUTION: Equipment Damage</p> <ul style="list-style-type: none"> ❖ Only use components or accessories recommended or sold by OutBack Power Technologies or its authorized agents. ❖ Connection of the system must be to a 3-phase AC source which is 480 Vac nominal only. ❖ Inverters must be provided with an equipment ground according to NEC 690.43. ❖ All five circuits (L1, L2, L3, neutral, ground) must be connected. Neutral must be bonded to earth ground. Failure to do so can damage the unit and void the warranty. ❖ The inverter has inputs for two separate DC strings. Reversal of polarity of one or both string inputs will irreparably damage the unit. ❖ Do not allow water to enter the AC or DC connectors. Water entry can damage the unit and void the warranty. ❖ In order to maintain the integrity of the watertight enclosures, all connectors must be properly and fully engaged. ❖ The utility connection can suffer from repeated disturbances depending on atmospheric effects, utility abnormalities, local loads, and the physical location. These disturbances can damage equipment. It is recommended that an appropriate surge suppressor be installed near the point of common connection with the utility.
	<p>IMPORTANT:</p> <ul style="list-style-type: none"> ❖ All electrical installations must be performed in accordance with all applicable local, state and national requirements, including ANSI/NFPA 70. ❖ The inverter system is a utility-interactive system. Before connecting any PV system to the utility grid, contact the local utility company. This connection should only be made by qualified personnel. ❖ The inverter components contain no user-serviceable parts. For all repair and maintenance, always contact an authorized dealer or installation partner.
	<p>IMPORTANT: Gateway AC Connection Procedures</p> <ul style="list-style-type: none"> ❖ To connect: Plug the AC cable into the Gateway FIRST, then plug the other end into the wall outlet. ❖ To disconnect: Unplug the cable from the AC wall outlet FIRST, then proceed to disconnect the cable from the Gateway device.
	<p>NOTES:</p> <ul style="list-style-type: none"> ❖ This product is provided with DC circuit protection in accordance with the requirements for ungrounded systems as outlined in 2014 NEC 690.35(C). ❖ This product meets the requirements of both 2014 and 2017 NEC 690.11 for DC arc-fault protection. ❖ This product meets the requirements of 2014 NEC 690.12 for rapid shutdown. ❖ Before installation, carefully read all instructions, cautions, and warnings in this manual.



Introduction

Thank you for purchasing a ProHarvest inverter system. The PHXL480-10k is an easy-to-install, modular system which is optimized specifically for commercial rooftop ungrounded PV array applications. Unlike other string inverters, each string is individually monitored and managed by the inverter.

Audience

This manual provides instructions for installation, setup, and operation of the product. These instructions are for use by qualified personnel who meet all local and governmental code requirements for licensing and training for the installation of three-phase power systems with AC and DC voltage up to 1000 volts. They must also be familiar with communication networks. This will require knowledge of acquiring real-time and historical data via computers and other external devices. Failure to install or use this equipment as instructed in the literature can result in damage to the equipment that may not be covered under the limited warranty. This product is only serviceable by qualified personnel.



IMPORTANT:

This manual provides safety guidelines and installation information for the ProHarvest inverter. It does not provide information about specific brands of PV modules.

Features

The PHXL480-10k inverter system has the following features.

- o 480 Vac three-phase grid service, wye configuration
- o Nominal power output 9.975 kW
- o Maximum power point tracking (MPPT) performed individually for each PV string
- o Performance tracking performed individually for each PV string
- o Type 6 Ingress Protection (per UL50), watertight
- o Arc detection
- o Easily liftable (30.6 lb)
- o Can be mounted in any orientation
- o No electrolytic capacitors

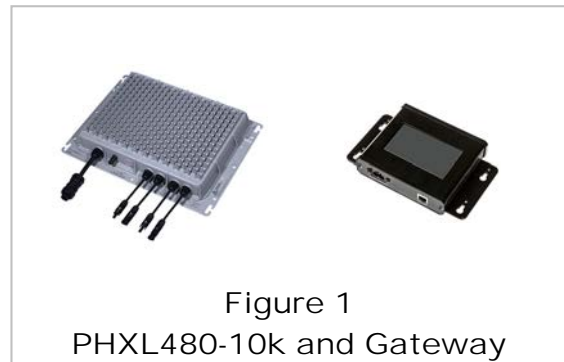

Figure 1

PHXL480-10k and Gateway

Components and Accessories

- o One PHXL480-10k inverter connects to up to 2 strings of PV modules. It also connects to the three-phase, 480 Vac-compatible utility connection on the installation site. The ProHarvest inverter is a non-isolated inverter for use with ungrounded DC systems.
Multiple inverter outputs may be connected in parallel using the splice box PROSPL-60.
- o One Gateway module connects to a 277 Vac / 60 Hz line-to-neutral branch of the utility connection used for the ProHarvest inverter (three-phase, 480 Vac-compatible). The Gateway module provides for system monitoring, logging and control. The Gateway is designed for indoor use only.
Internet access should be provided for the Gateway to enable firmware updates and to provide customer support functions.

System Overview

The PHXL480-10k is an easy-to-install, modular system which is optimized specifically for commercial rooftop ungrounded solar array applications. Unlike other string inverters, each string is individually monitored and managed by the inverter.

A typical layout is shown in Figure 2. It depicts two strings of PV modules supplying a single inverter. A Gateway is shown connected to one 277-Vac phase. Note that while the Gateway provides detailed reporting and user control, it is optional. The system will generate power without it.

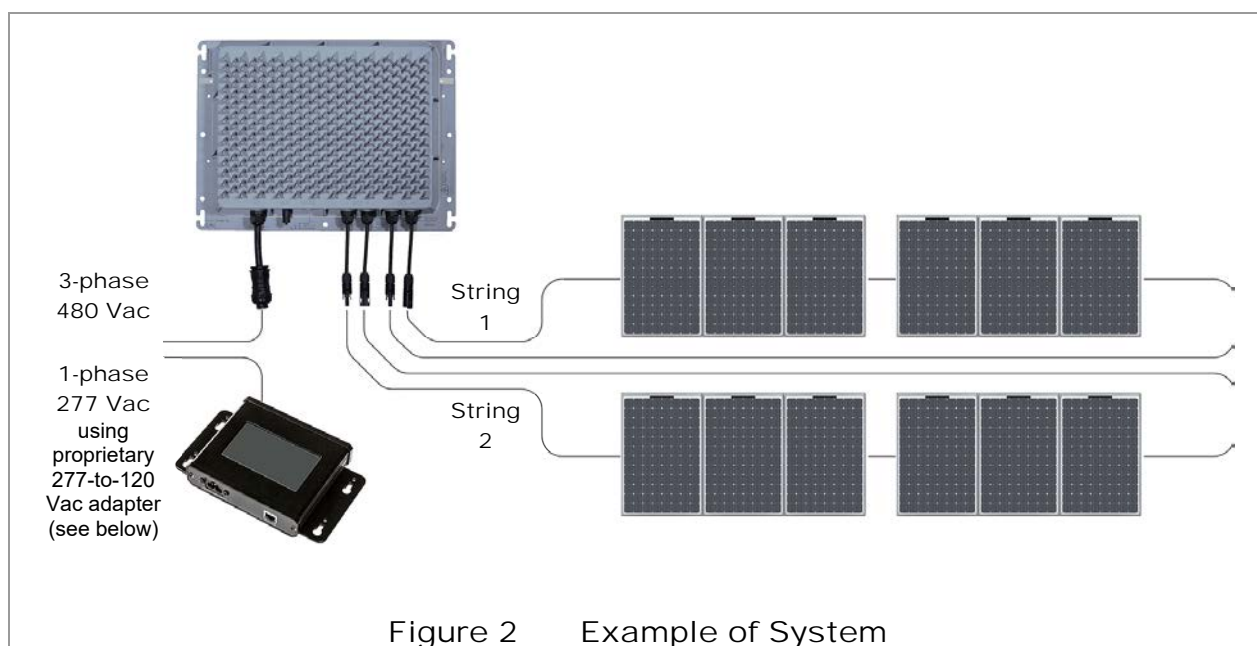

Table 1 System Ordering and Part Numbers

Item	Part Number	Description
Inverter, 9.975 kW, 480 Vac 3-phase	PHXL480-10k	Inverter with MC4-compatible connectors (1 each). Includes 10-year limited warranty. Does not include Gateway or AC cable. These two items must be ordered separately.
480 Vac inverter AC Cable	CBL-480A-05 CBL-480A-15 CBL-480A-30 CBL-480A-50	5 ft, 15 ft, 30 ft, and 50 ft. Each includes one 480-Vac mating connector; the other end is unterminated.
Connector Tools	TOOL-KIT-1	MC4-Compatible Connector Unlatching Tool (10 each), plus AC Connector Unlatching Tool (10 each)
AC Splice Box	PROSPL-60	AC combiner splice box, NEMA4 enclosure. Includes 3 gland fittings for up to 3 inverter AC cables. Inverter AC cables must be ordered separately.
Gateway	PROGW-A-277	GW-A Gateway (1 each). Includes 277-to-120 Vac adapter and ethernet cable (1 each). Also includes memory card for logging and storage of results.
Ballast Roof-Mount System	MNT-TS1-01	Mounting system for one inverter. Includes mounting feet (4 each) and associated hardware.



Planning

Design Guidelines

DC Stacking Ratio

The ratio of PV module STC power rating to inverter output power rating is often referred to as “Stacking Ratio.” Most PV installations are designed for a stacking ratio greater than 1, and less than 1.5. However, the only real limitations on stacking ratio for the ProHarvest inverter are the voltage and current limitations of the string inputs. The maximum power point tracking voltage range for the string inputs is 450 to 850 Vdc. The specified maximum short circuit current of the DC source is 30 Adc. However, the specified stacking ratio is a maximum of 4.0.

A more practical limitation is due to the power and current limits imposed by the inverter firmware. Input power is limited to 6 kW per string and input current is limited to 12 Adc per string.

Ideal stacking ratio varies by installation. For the vast majority of installations, a stacking ratio between 1.25 and 1.5 is acceptable. Under some conditions (constant high irradiance) a lower stacking ratio may be preferred. A stacking ratio of 1.1 to 1.25 typically allows for energy harvest loss factors such as module orientation that is less than ideal, inverter efficiency losses, module soiling, module aging, etc. Still, in some cases a stacking ratio of 1.5 or greater can be advantageous. For example, in the northern hemisphere a north-facing array, an east- or west-facing array, or high ambient temperatures may justify a higher stacking ratio.

Also, as soil and age, their power output decreases. In addition, the STC rating of modules is typically very optimistic. In reality, most modules produce approximately 85 to 90% of their STC rating. The system designer is responsible for specifying the string parameters to remain within the inverter ratings.

Location

The ProHarvest is suitable for flat, commercial rooftops, carports, ground mounts, and other commercial installations. It may be placed using the self-ballasting metal casing. Alternatively, it may be attached to a PV module frame or roofing component using the provided attachment mechanisms.

Inverter Placement

The PHXL480-10k inverter is Type 6 rated (according to UL50) and may be placed almost anywhere. Cooling is most efficient if the unit is mounted vertically in the shade, bolted to racking, and with the connectors pointing downwards. However, any orientation is acceptable.

Clearances

Provide the following minimum space between the inverter and other inverters, or other surfaces.

- 1" on all sides
- 4 to 5" from the heat sink (in any direction) to allow air circulation around the cooling fins
- 1" from the main mounting surface (using the ballast roof-mount system, Unistrut mounting, etc.)

Gateway Placement

Internet access should be provided to enable firmware updates and customer support functions.



CAUTION: Equipment Damage

The Gateway is not rated for outdoor installation.

- o The Gateway is rated for indoor installation only. Do not expose it to rain, extreme temperatures, or excessive dust. It must be mounted indoors. A utility closet or similar location physically close to the inverter system is ideal. If outdoor placement is required, the Gateway must be housed in a weatherproof enclosure.
- o The Gateway must be electrically connected to one of the three AC phases used by the inverter. Note that in large utility closets it is often easy to accidentally connect to an unrelated AC circuit.
- o The Gateway should be protected by a 15 Aac overcurrent protection device (OCPD).
- o To provide the best power line communication (PLC) signal possible, it may be useful to add a 277 Vac outlet at the earliest entry point in the building. The ideal outlet location would be next to the circuit breaker.
- o A wired Ethernet network connection must be provided to the Gateway for proper data retrieval.
- o The Gateway has 'keyhole' mountings on its baseplate. Each hole has a guide hole. (See Figure 3.) These four holes can provide a template for mounting such that a pen or center punch can be inserted to mark the wall and ensure accurate drilling of holes. The Gateway can be mounted using #8 screws.

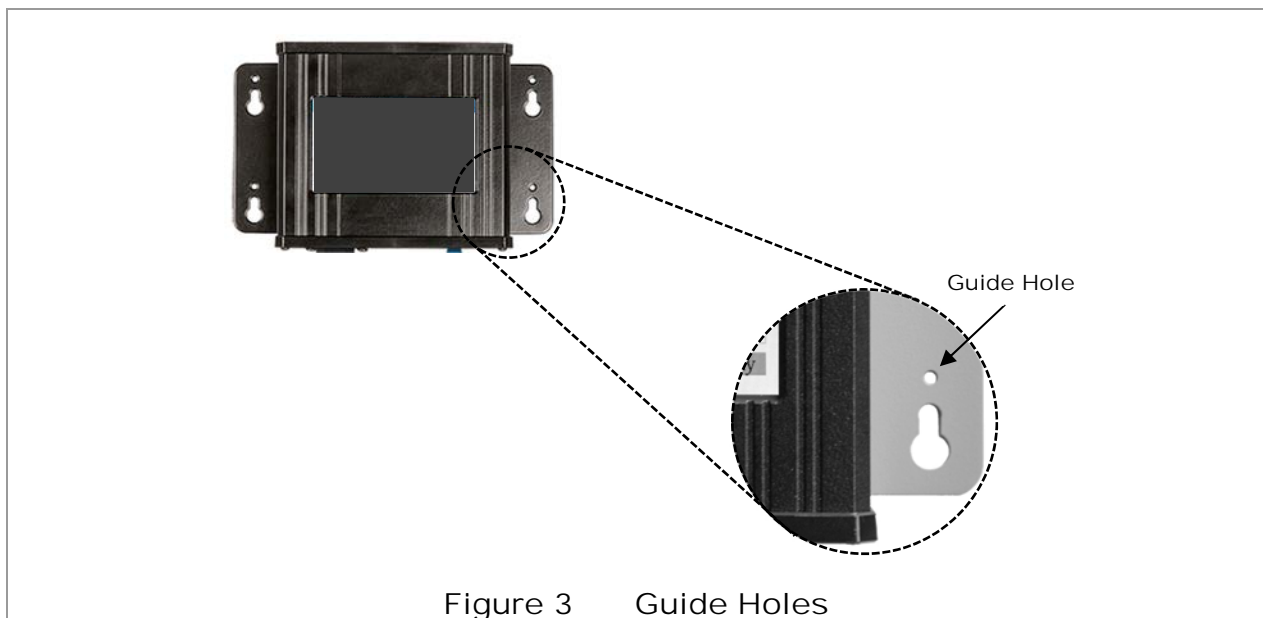

Figure 3 Guide Holes

Surge Suppression



CAUTION: Equipment Damage

Depending on physical location, atmospheric effects, utility abnormalities, and local loads, the utility connection can suffer from repeated disturbances which can damage equipment. It is recommended that an appropriate surge suppressor be installed near the point of common connection with the utility.



Installation

The ProHarvest PHXL480-10k employs industry-standard connection methods. These include locking interconnects for PV module attachment and standard 5-lead, three-phase AC wiring compatibility. Make certain to follow all instructions carefully.

Buttons and Indicators

While most installations will use a Gateway to control and report, it is not mandatory. The ProHarvest has a single button with eight LED indicators to give responses and operating states. The inverter can be controlled using the button as shown in Table 2. Other ProHarvest status messages provided by button illumination are shown in Table 3 on the next page.

The LED indicators will not become active until the inverter receives power. See the **Connection Outline** section beginning on page 13 for power-up.

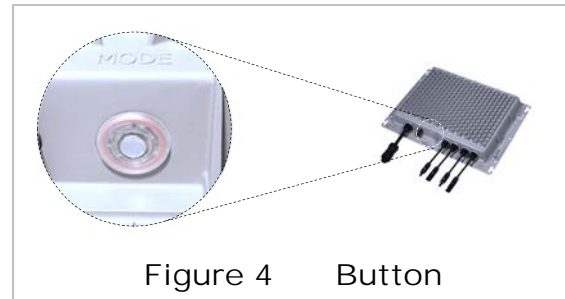

Figure 4 Button

Table 2 Inverter Commands (Button)























Inverter Button Press	Button Indication	Result
1 press 		o Make inverter beep (“are you alive?”)
2 presses 		o Off & Locked (disabled) o Unit will not begin the 5-minute self-start
3 presses 		o Start generating immediately o If locked, unlock and generate immediately o If system is faulted, unit will unlock but will not generate
Long press and Additional Messages:		
Long press (>2 seconds) 		o “Alternate functions” mode o Ready to accept further button pushes; this operation times out after 10 seconds
1 press (after long press) 		o Clear latched faults after (for example) an arc-fault test or RCD (residual-current device) test initiated a fault condition
3 presses (after long press) 		o RCD-test activation; successful operation of RCD test should cause a fault condition (rapid red flashing) until cleared
4 presses (after long press) 		o Arc-fault test activation; successful operation of arc-fault detection should cause a fault condition (rapid red flashing) until cleared

Table 3 Inverter States (Button)

Inverter Indicator State	Button Indication
<p>Green solid</p> 	<ul style="list-style-type: none"> o Powered up o Not generating (5-minute timer may be running) o No faults
<p>Green, left-right alternating flash</p> 	<ul style="list-style-type: none"> o Power-on self-test (will take <1 minute)
<p>Green, clockwise circular flash</p> 	<ul style="list-style-type: none"> o Powered up o Generating o No faults
<p>Red rapid flash</p> 	<ul style="list-style-type: none"> o Fault condition <p>Examples:</p> <ul style="list-style-type: none"> • Arc has been detected • No grid
<p>Green flash, mostly on</p> 	<ul style="list-style-type: none"> o Off & Locked o Disabled
<p>Green flash, mostly off</p> 	<ul style="list-style-type: none"> o Sleeping o Not generating

Connection Outline

	<p>CAUTION: Equipment Damage</p> <ul style="list-style-type: none"> ❖ The system must be connected to 480 Vac 3-phase wye 5-wire only. ❖ The inverter must be provided with an equipment ground according to NEC 690.43. ❖ All five circuits (L1, L2, L3, neutral, ground) must be connected and neutral must be bonded to earth ground. Failure to do so can damage the unit and void the warranty. ❖ The ProHarvest inverter has inputs for two separate DC strings. Reversal of polarity of one or both string inputs will irreparably damage the unit. Use a voltmeter to carefully verify that the DC inputs are correct before connecting to the inverter DC inputs. ❖ The Gateway is for indoor use only. ❖ In order to maintain the integrity of the watertight enclosures: <ul style="list-style-type: none"> ✓ All connectors must be properly and fully engaged. ✓ Unused connectors must be sealed using appropriate weatherproof caps. ❖ Do not allow water to enter the AC or DC connectors. If this occurs, the warranty will be void. ❖ Make certain the Gateway is kept within the specified temperature range of -20 to +50 °C. In extreme cold conditions, a heater may be needed.
	<p>NOTE:</p> <ul style="list-style-type: none"> ❖ Up to five inverters may be connected on the same branch to a single 80 Aac OCPD. ❖ A NEMA4 AC Splice junction box is available for use with up to three 480 Vac inverters. ❖ Perform all electrical installations in accordance with all applicable local electrical codes.

Connection Order

Make connections in the following order:

- A. (Page 14) Connect an equipment ground to the inverter. This step should always be performed first.
- B. (Page 15) Connect the inverter to the utility grid, leaving the connection turned off.
- C. (Page 17) Connect the PV module strings to the inverter inputs.
- D. (Page 18) Turn on the AC source.
- E. (Page 19) Connect the Gateway to one 277 Vac (line-to-neutral) branch of the same 480 Vac circuit as the inverter and the network. Observe the inverter's operation.
- F. (Page 21) Unlock any inverters that powered up in the **Locked Off** state.

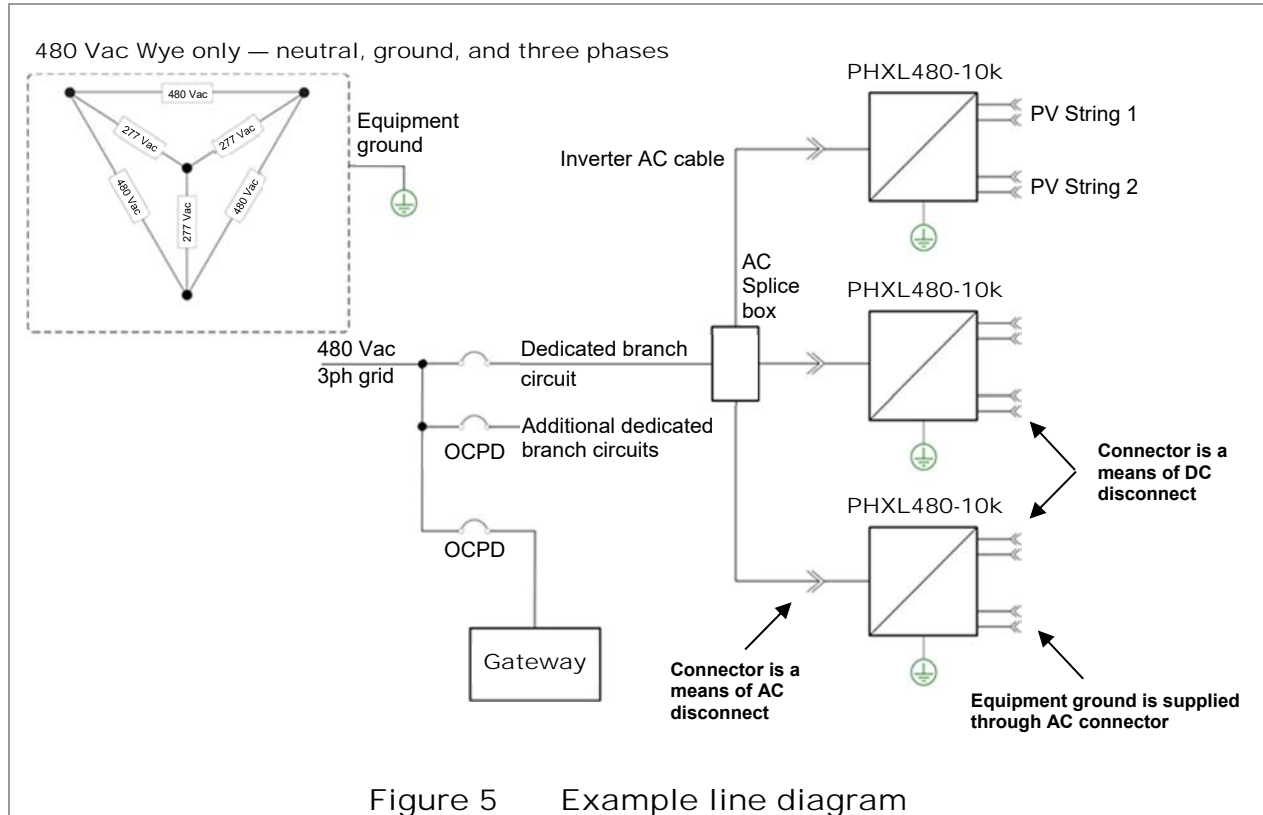

Connection Steps

A. Grounding

This connection should always be established before taking any other steps.





To establish a ground connection:

1. Connect the metal enclosure of the inverter to earth ground according to NEC 690.43.
 - The equipment ground is provided through the AC connection. The system may also be grounded using the mounting bolts to any properly grounded metallic structure. A paint-cutting washer, such as a stainless steel star washer, must be used.
 - In Canada, the system may be grounded by connecting a ground conductor to a lay-in lug (not provided) attached to the chassis. See Figure 6.



B. AC Wiring

To connect the inverter to the utility grid:

	<p>WARNING: Shock Hazard This product incorporates high voltages.</p>
	<p>CAUTION: Equipment Damage The neutral must be bonded to earth ground. Failure to do so can damage the unit and void the warranty.</p>
	<p>IMPORTANT: The unit is only watertight when connectors are fully engaged.</p>
	<p>NOTE: The inverter AC cables are TC-ER rated¹.</p>

1. Connect the inverter AC cable (sold separately) to the 480 Vac circuit. Follow the wiring conventions shown in Figure 7.
 - All five conductors (L1, L2, L3, neutral, ground) must be connected. Note that particular care is required to ensure that an effective neutral connection is maintained when a transformer is part of the installation. See page 16.
 - The inverter exports power only on the “line” (hot) conductors. The neutral conductor is used solely for voltage sensing and power line communications.

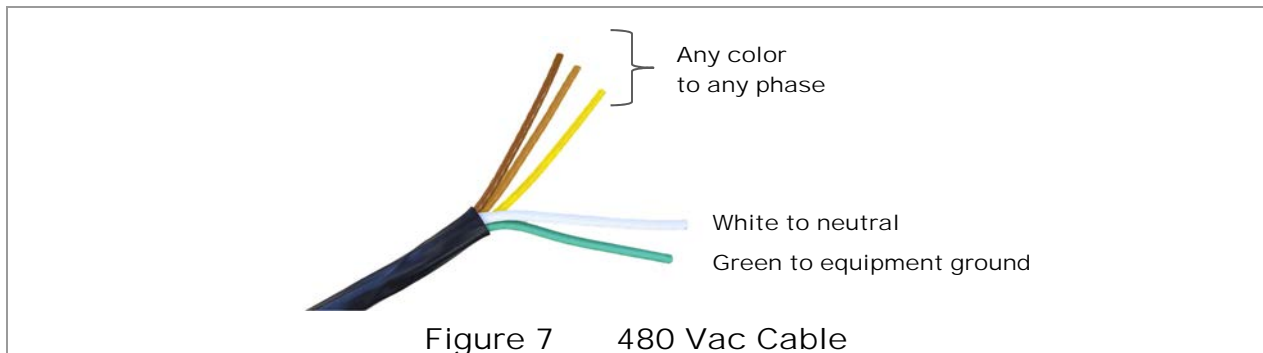

2. Connect the inverter to the AC system by connecting the AC cable plug to the inverter plug as shown in Figure 8.



3. Do not turn on AC power to the inverter until instructed in Step D on page 21.

¹ The “-ER” signifies that the cable is sufficiently rugged for the NEC (section 336.10) to permit its use as “exposed wiring”. This refers to wiring not installed in a tray, conduit or other raceway. It must be secured every 6 feet or less and protected from physical damage.

Installation

Disconnecting the AC Plugs

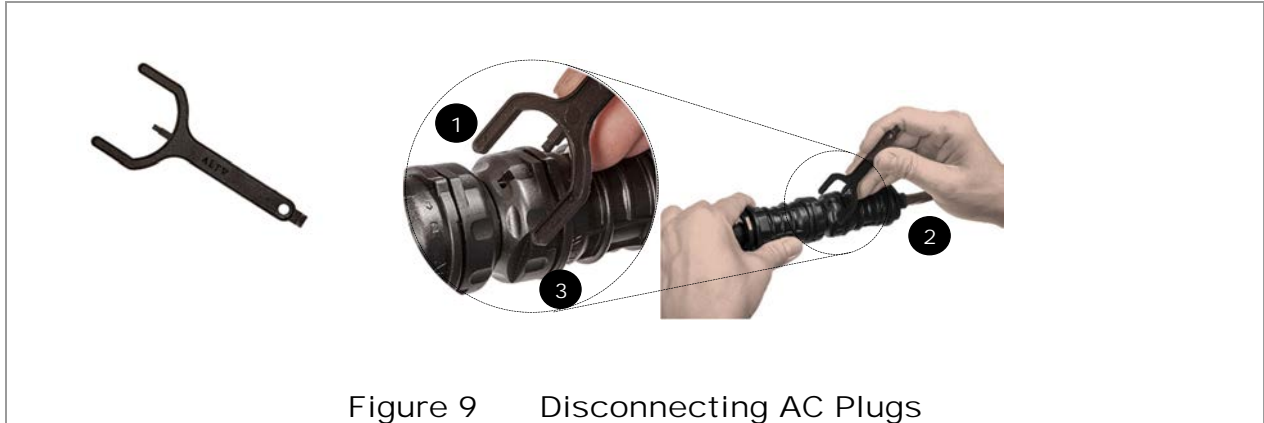

The PHXL480-10k comes in a connector-less version for installation locations which have another form of AC disconnecting means or do not require it, per local electrical codes. For this instance, in addition to the retainment mentioned above, the AC cable must be secured within 3 feet of the unit.

Using a Transformer

While ProHarvest inverters may be used with a transformer, care must be taken to ensure proper wiring.



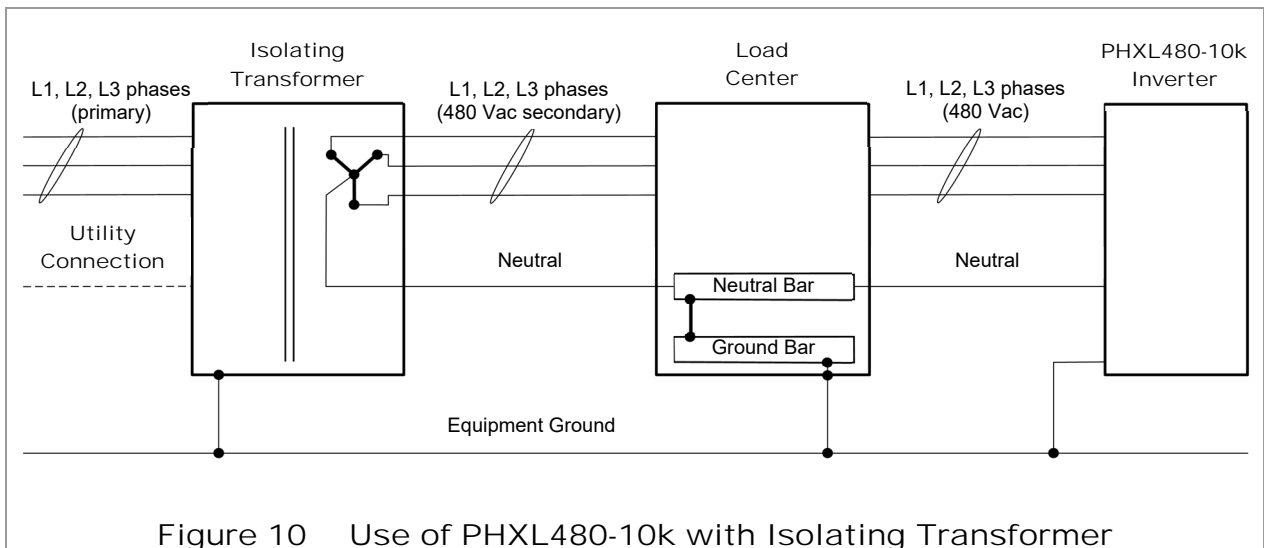

CAUTION: Equipment Damage

The neutral must remain bonded to earth ground. When an isolating transformer is inserted into the circuit, the neutral may lose any path to equipment ground that was provided elsewhere. Make sure a neutral-ground bond is established on the inverter side of the transformer. An example of bonding in the load center is shown in Figure 10.



C. PV Module Connection

To connect the strings of PV modules:

	<p>CAUTION: Equipment Damage Do not reverse the polarity of the DC inputs. This will cause irreparable damage to the ProHarvest inverter.</p>
	<p>IMPORTANT: The unit is only watertight when connectors are fully engaged.</p>
	<p>NOTE: Connection may be made with the AC source on or off. This section assumes the source is off.</p>

1. Connect the male and female plugs, inserting them together by hand as shown in Figure 11.
2. With DC voltage present (but AC power turned off), the inverter button will flash red. (See page 11.) This is normal when no grid is present.

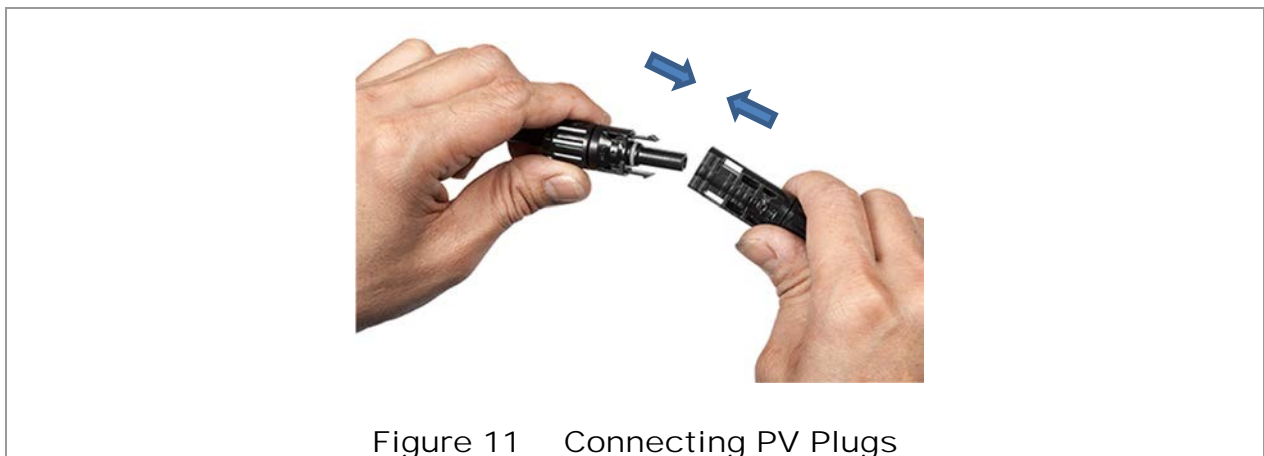

Figure 11 Connecting PV Plugs

Disconnecting the PV Plugs

1. Use the DC tool to disconnect the male and female connectors. Follow steps 1 and 2 in Figure 12.

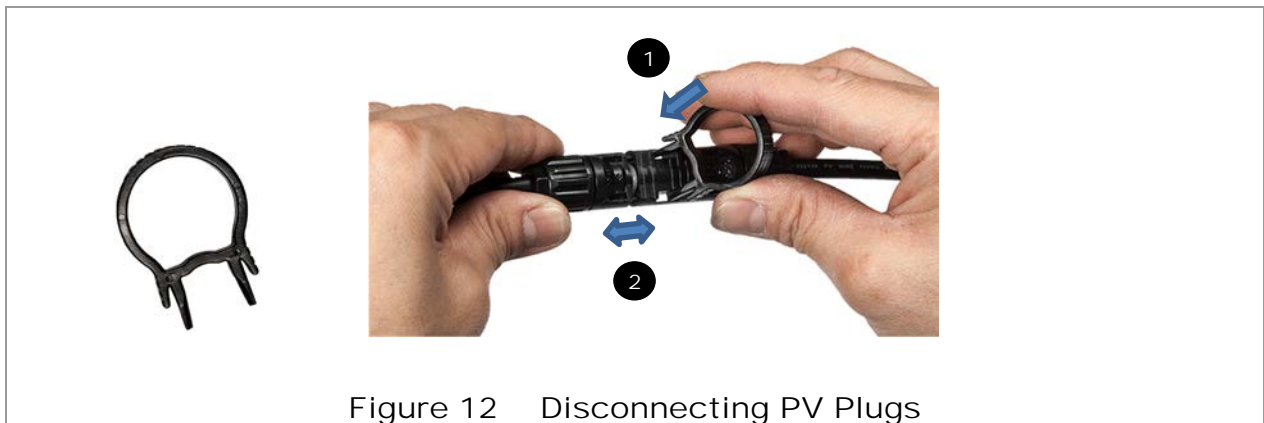
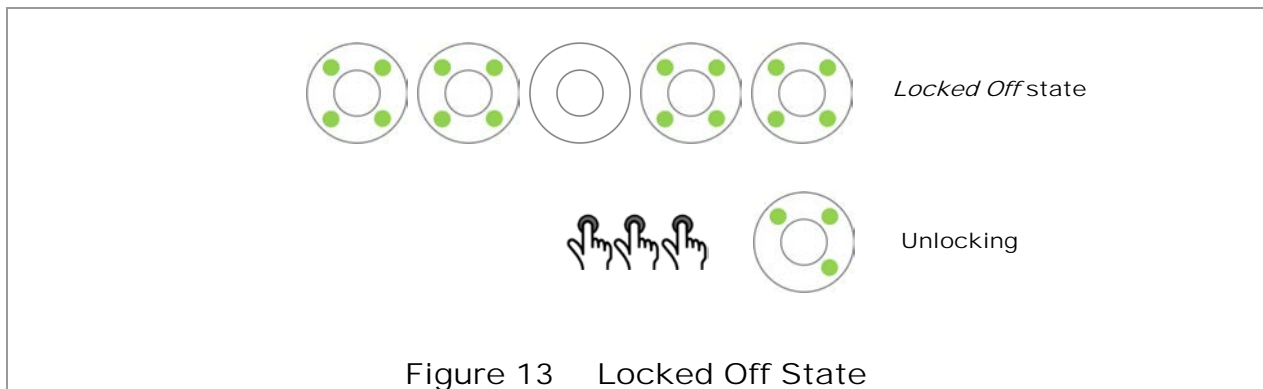

Figure 12 Disconnecting PV Plugs

D. AC Power-Up



To power up the inverter:

1. Turn on the utility grid connection. This starts a 5-minute timer. While this timer runs, the inverter tests the grid power to ensure all requirements are met. When this timer expires, each inverter will perform a self-test and then begin generating.
 - To skip the 5-minute timer, see page 21.
2. Observe the inverter button LED indicators. (See page 11.) During the wait period, all lights will be solid green. Once the period expires and the inverter begins generating power, the green lights will flash in a clockwise circular motion.
 - This does not apply if the inverter is in the **Locked Off** state. (See page 21.) In this state, the ProHarvest inverter is active but is prohibited from generating power. The locked state is indicated by all green indicators flashing.
 - An individual inverter may be unlocked by pressing the inverter button three times (Figure 13).
 - The Gateway can unlock multiple inverters at the same time. See page 21.



E. Gateway Connection

To connect the Gateway:

	<p>CAUTION: Equipment Damage The Gateway is rated for indoor installation only.</p>
	<p>NOTE: The Gateway should be located as near to the inverter(s) as possible for reliable communication.</p>

1. Connect the Gateway power cable (sold separately) to one 277 Vac (line-to-neutral) branch of the same 480 Vac circuit as the inverter and the network. Make certain to use the 277 Vac adapter sold with this product.
2. An Ethernet connection may also be made at this stage.

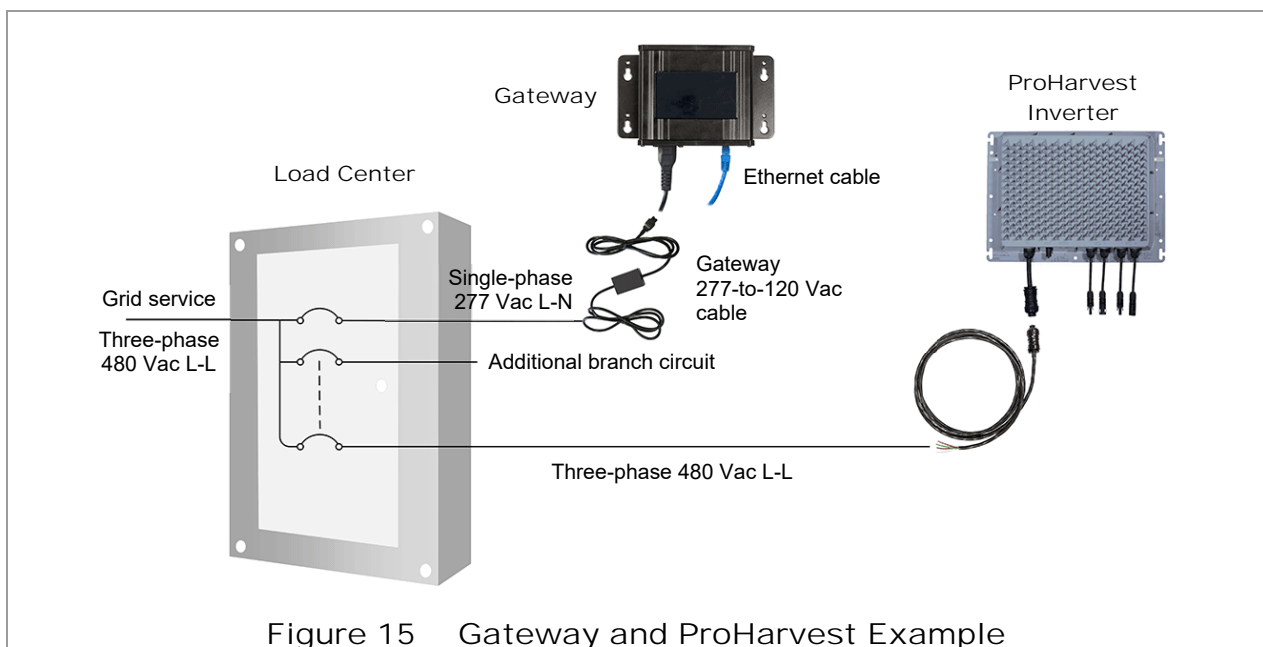
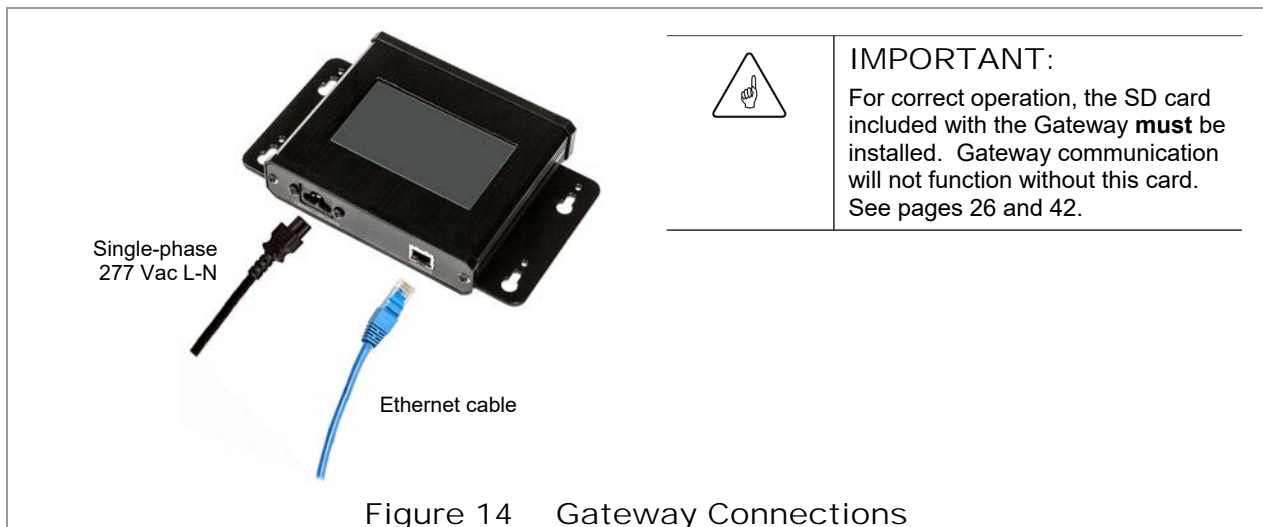

Installation

3. Turn on AC power to the Gateway and wait for the screen to illuminate.
4. On the Gateway screen, select the **Inverters** tab A at the top of the screen if it is not already selected. (See Figure 16. Also, see pages 23 and 26 for Gateway navigation and inverter states.)
 - To check inverter status, press the **Setup** button B. On the **Array Setup** screen, press the **Discover** button F. The Gateway will search for all inverters. Confirm that they indicate **Healthy** status as shown in C.
 - To check the status of the PV strings connected to each inverter, press the **Strings** button D. On the **Inverter Strings** screen, confirm that they indicate **Healthy** status as shown in E.

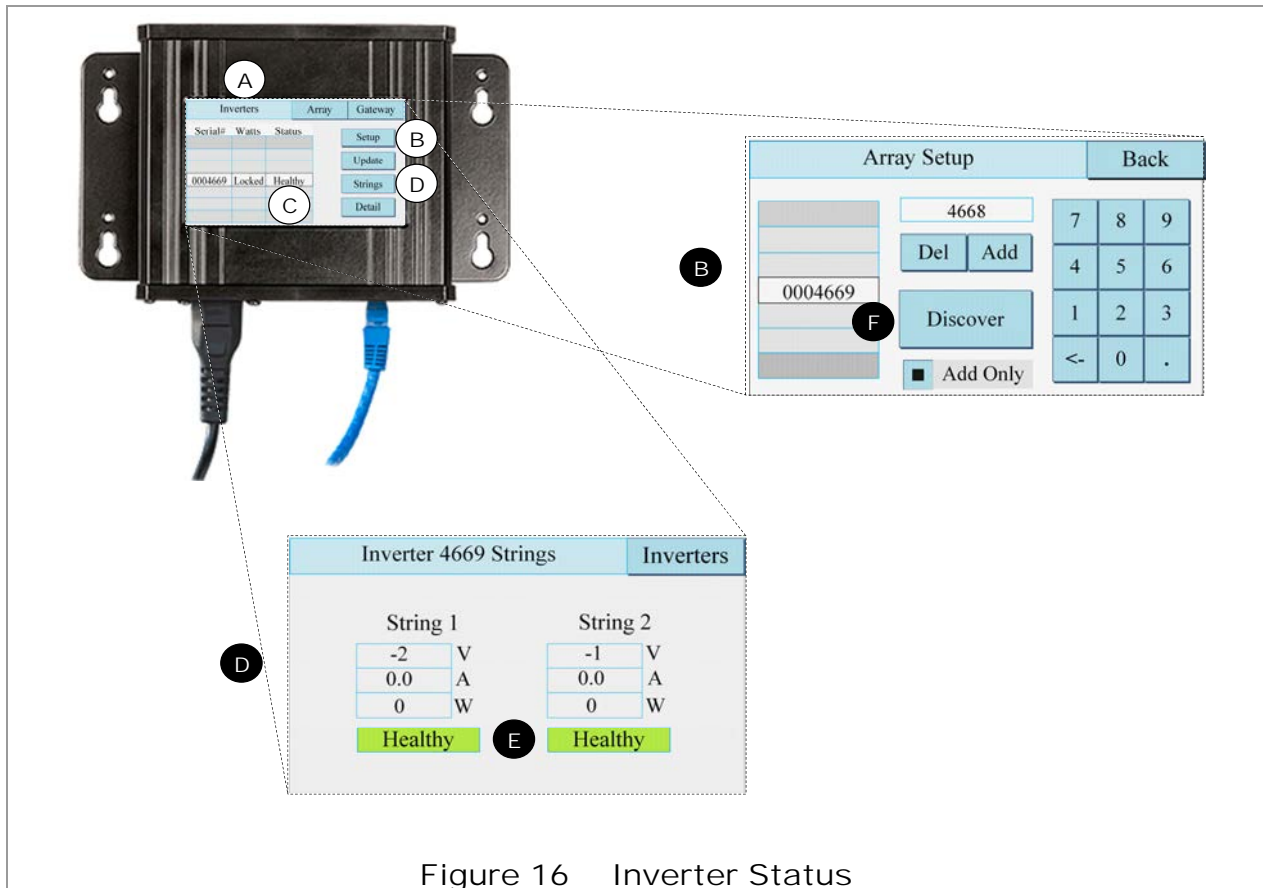

Figure 16 Inverter Status

F. Unlocking and Locking Inverters

On page 18, when AC power is applied, the inverter will begin a 5-minute timer to test the utility grid. Once the timer expires, the inverter may power up in the **Locked Off** state. This prevents the system from generating power when not desired.

To unlock inverters in the *Locked Off* state:

- To unlock an individual inverter, press the inverter button three times. See pages 11 and 18.
- To unlock multiple inverters, open the Gateway's **Array** tab. The Off+UnLock button B will unlock all inverters in the system. (See Figure 17. Also, see pages 23 and 26 for Gateway navigation and inverter states.)
- To skip the 5-minute wait, press the Power On button A. The units will self-test and then begin generating. (See Table 3 on page 12 for the LED indications of self-test.) Once self-test has been successfully completed, power generation begins.
- To place the inverter in the locked state, press the Off+Lock button C.

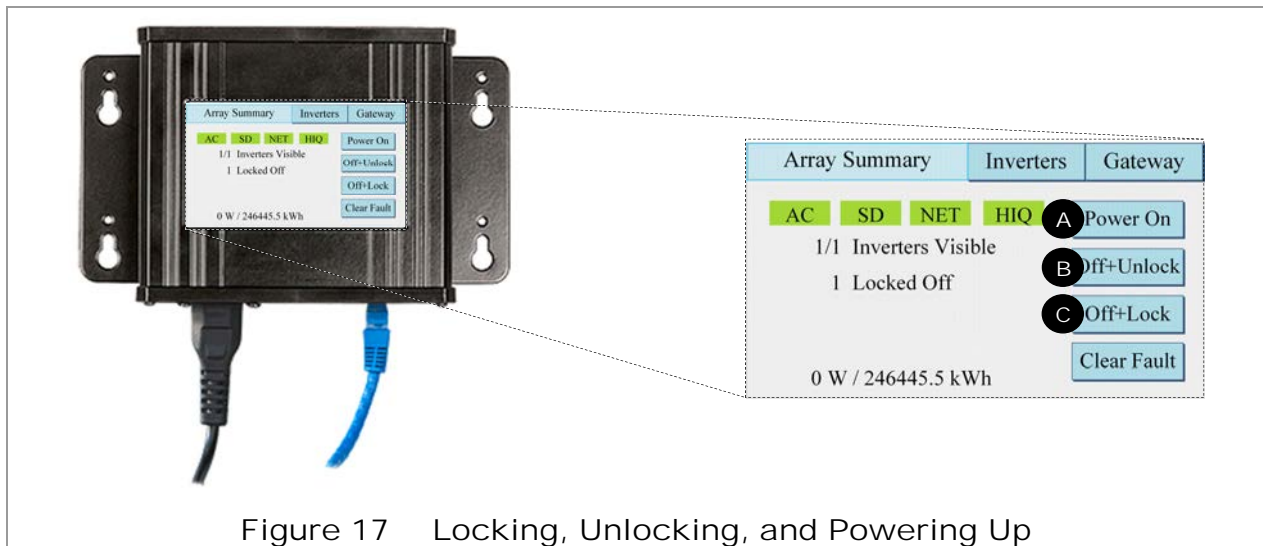

Figure 17 Locking, Unlocking, and Powering Up

Connection is complete.

Disconnection

When disconnecting the PHXL480-10k, perform the lettered steps (from pages 14 through 19) in reverse. (See Figure 9 on page 16 and Figure 12 on page 17.) The ground is the last item to be disconnected.



WARNING: Shock Hazard

Before disconnecting DC cables, use a current clamp meter to measure the presence of current. If current is present, cover the portion of the array affected (following NEC 690.18).



Gateway

Gateway Operation

The Gateway (sometimes referred to as the Communications Gateway) is a module used for interface and communication with ProHarvest inverters.

- o The Gateway uses power line communication (PLC) to communicate with the ProHarvest.
- o The user can check status and change settings on the Gateway using a touch screen. If Ethernet communication is enabled, the user can access these functions on a web page.
- o The Gateway can also archive performance history on a memory card.

Touch Screen

The Gateway touch screen has three tabs: **Array**, **Inverters**, and **Gateway**. When selecting any tab, it moves to the left side of the screen and opens a new series of options. The names of some selections may expand when pressed.

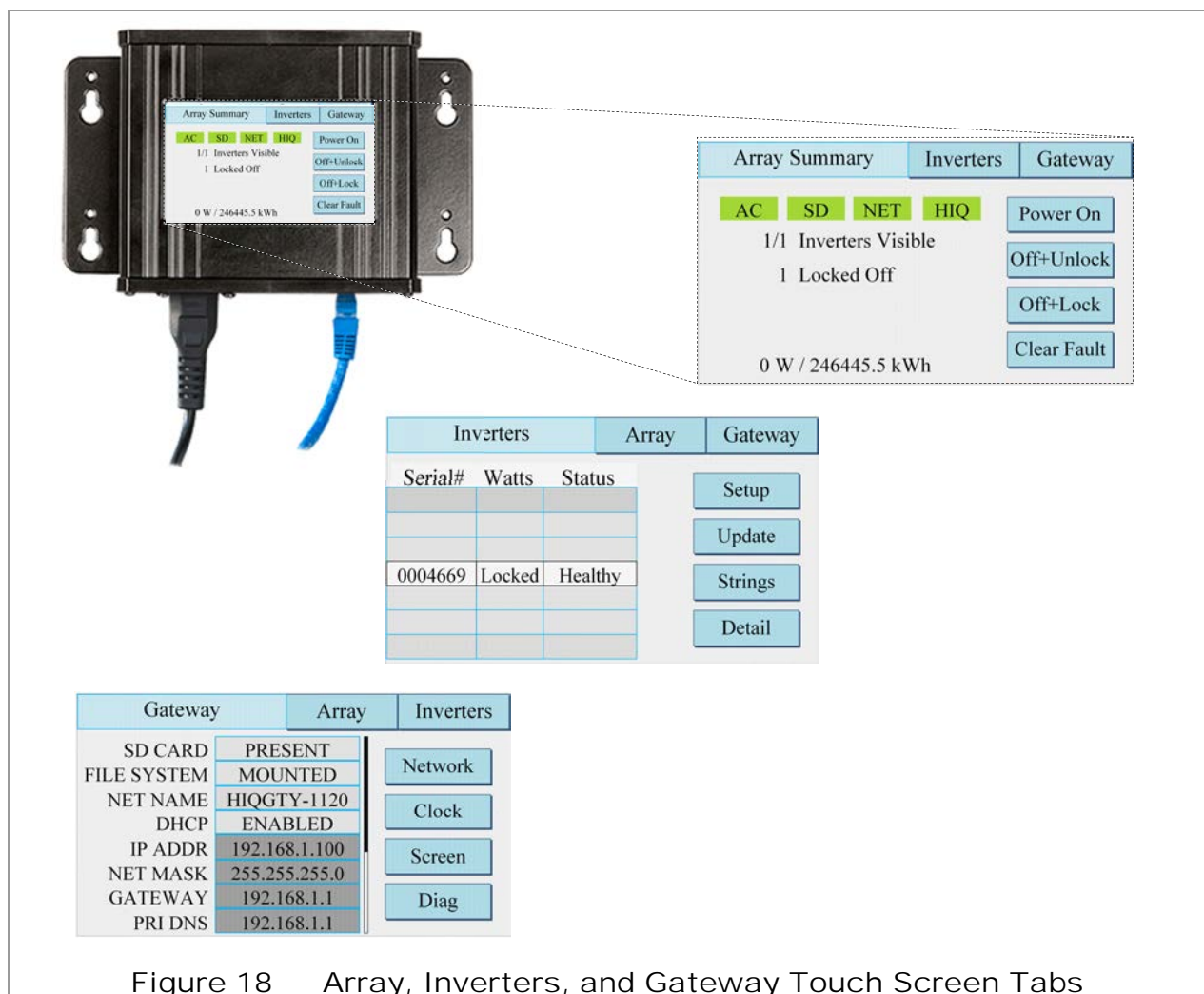

Figure 18 Array, Inverters, and Gateway Touch Screen Tabs

Menu Map

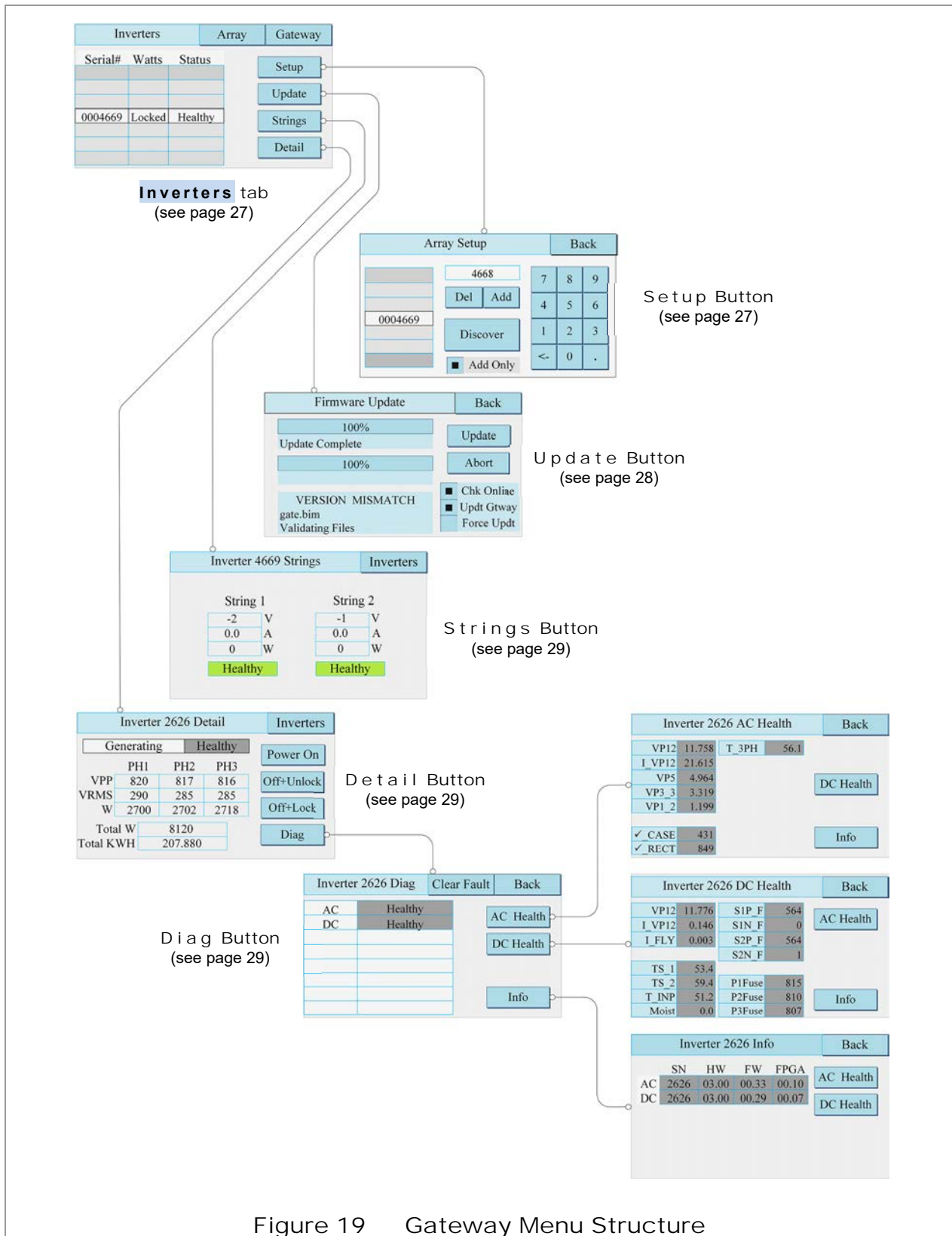

Figure 19 Gateway Menu Structure

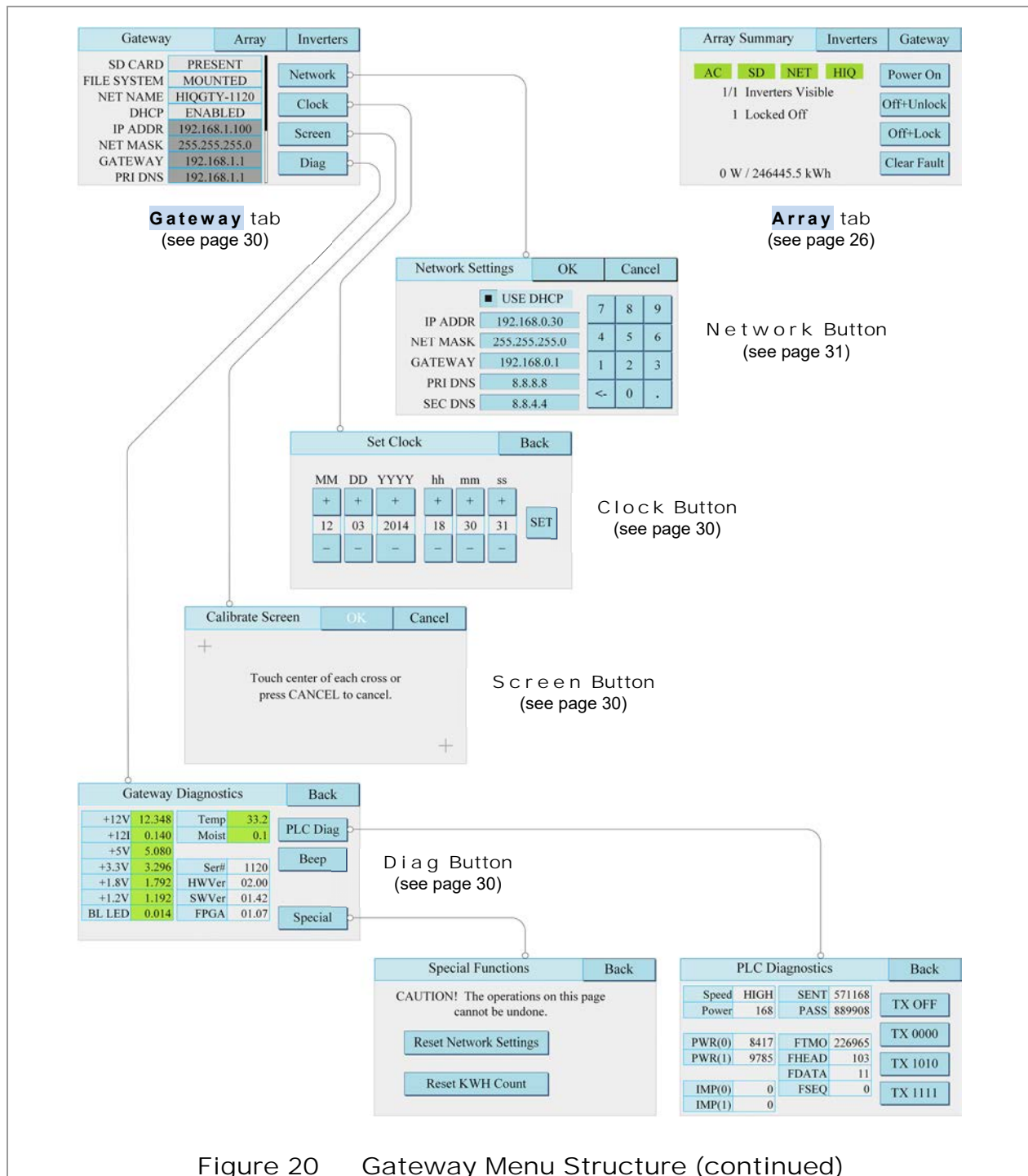

Figure 20 Gateway Menu Structure (continued)

External Access

The Gateway gathers data from inverters using PLC and displays information on its touch screen. With a suitable Ethernet connection, it is capable of acting as a web server, allowing a local computer or a remote computer with firewall access to see real-time system performance displayed on a web page. Data is also transferred to servers to gather history, which can be accessed remotely. See **Accessing the Gateway** on page 31 for login instructions.

Array Tab (Array Summary Screen)

The **Array** tab opens the **Array Summary** screen, which features several ProHarvest status indications. Despite the name, most of these indicators do not show the status of the PV array. This screen also features four buttons.

Power On: This button orders all inverters to begin generating (harvesting and selling PV power). See page 21.

Off+Unlock: This button orders all inverters to stop generating momentarily. The inverters are “unlocked” and not prevented from continuing to operate. The inverters will examine grid conditions while counting down the 5-minute delay timer (see page 21). If conditions are acceptable, the inverters will resume generating. This is the default state.

Off+Lock: This button orders all ProHarvest inverters to stop generating. The inverters are “locked” and will not generate until the **Power On** button is pressed.

Clear Fault: If an arc fault or ground fault occurs, once the cause is remedied, this button clears the fault condition. This takes effect on all inverters. The **Clear Fault** button has the same effect (“clear latched faults”) as the physical button located on each inverter (see page 11). However, the inverter button only clears faults on that particular inverter.

The four indicator flags show different aspects of ProHarvest or Gateway operation. All items will be shaded green if the statements below are true. If any item is not correct, it will be shaded red.

AC: The Gateway's AC source is correct. Among other things, the ProHarvest has detected that the neutral connection is present, voltage is within tolerance, and no dangerous voltage spikes are present.

SD: The SD card is inserted and the file system is working.

NET: The network is connected. The cable connection is established and the Gateway has acquired an IP address.

HIQ: The Gateway was able to contact the server and upload data. This item will be shaded yellow while the Gateway attempts to make contact.

Two more status messages are available. The first has two numbers. **Inverters Visible** shows the number of inverters detected as compared to the number discovered or manually added in the **Array Setup** screen (see page 27). The second message indicates the last button pressed. (The message **Unknown** may indicate a communications problem.)

This screen also shows present PV power harvested (in watts) and lifetime harvest (in kilowatt-hours).

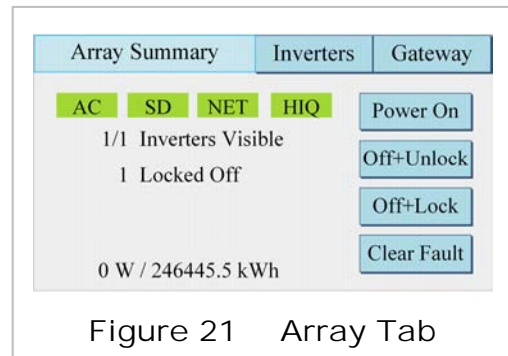

Figure 21 Array Tab

Memory Card

The Gateway is supplied with a memory card to allow long-term storage and retrieval of performance history. Make certain that it is fully inserted, as some functions are not available with the card not fully engaged. The card is pre-formatted with the FAT32 file system and is ready to be inserted into the Gateway as shown in Figure 22.

The Array Summary screen has an indication of the SD card status as shown in Figure 21. This indicator will turn red if the card is not fully engaged.

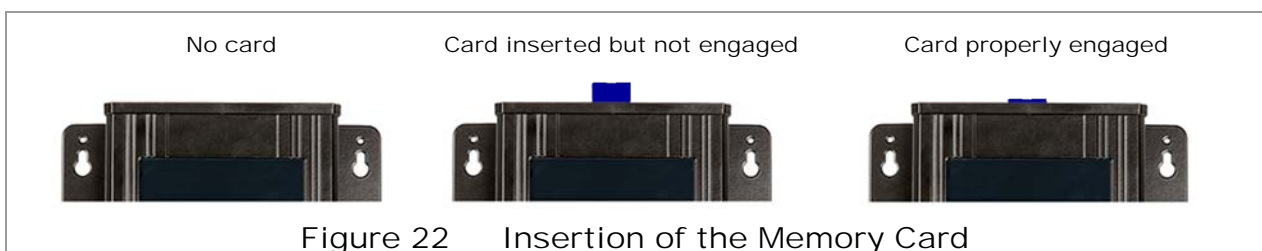

Figure 22 Insertion of the Memory Card

Inverters Tab

The **Inverters** tab opens the **Inverters** screen, which shows the status of all ProHarvest inverters. Units are listed by serial number and display the present power generation and general status. This screen also features four buttons.

Setup: This button leads to the **Array Setup** screen, allowing inverters to be added or deleted from the Gateway. See below.

Update: This button leads to the **Firmware Update** screen. See page 28.

Strings: This button leads to the **Strings** screen, showing PV status for each inverter. See page 29. (This screen was previously referenced on page 20 as part of the power-up procedure.)

Detail: This button leads to the **Detail** screen, showing real-time information for a single inverter. See page 29. This screen also leads to a series of diagnostic screens for troubleshooting.

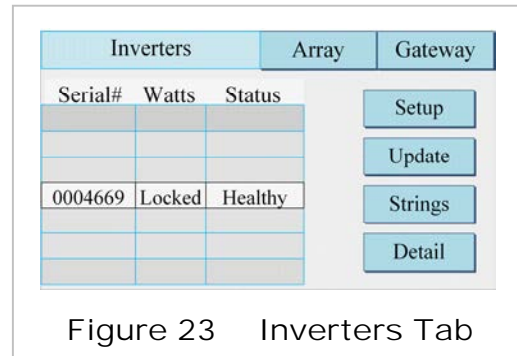

Figure 23 Inverters Tab

Setup

The **Setup** button opens the **Array Setup** screen. (This screen has nothing to do with the PV array.) To search for inverters, press the **Discover** button. This function uses PLC to locate all inverters in the immediate area. (These are usually inverters on the local side of an isolation transformer, though conditions vary.) In most cases nothing else is required. All available inverters will appear on the list in Figure 24. Inverters may also be automatically discovered from the web interface. (See Figure 25.)

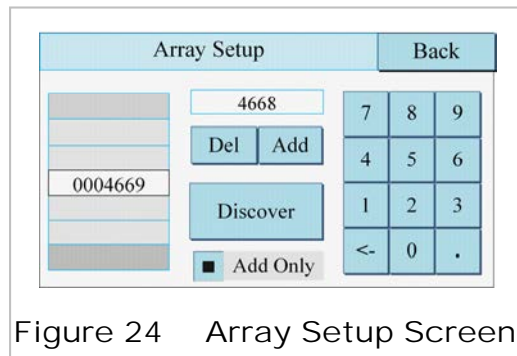

Figure 24 Array Setup Screen

The **Discover** button is normally shaded light blue. While discovering inverters, it changes to dark blue. It will turn red if PLC problems occur, such as too much background noise. The button must be pressed again once conditions have been corrected. Once discovery is complete, the button will return to a light blue color. A list of serial numbers of all inverters discovered (if any) will be displayed.

NOTE: If discovery occurred previously, check the **Add Only** box to speed up the process. (Only new inverters will be discovered.) Unchecking this box causes all inverters to be rediscovered from scratch.

Occasionally it may be preferable to manually add inverters to the list. It is particularly useful if an inverter is replaced on a site where automatic discovery would take a long time. Inverters can be added (or deleted) with the touch screen **Add** or **Del** buttons.



Figure 25 Adding and Removing Inverters using Web Interface

Using the web interface, inverters can be added (B) or deleted (C) using the onscreen options. Option A enables automatic discovery. (See page 31 for more information on the web interface.)

Update

The **Update** button opens the **Firmware Update** screen. System firmware is occasionally updated to add features and enhance reliability. Updates may be performed through a network connection or using a memory card physically inserted into the Gateway. (See page 26.)

Updates may be performed through the touch screen as shown in Figure 28. Pressing the **Update** button begins a check for available files, which are streamed directly to all inverters. Meter bars indicate the progress.

Chk Online must be selected for the Gateway to perform a network search. If **Updt Gtway** is selected, the Gateway's own firmware will be updated as part of this process.

Force Updt downloads inverter files to the Gateway, which then completes the inverter updates. This avoids any potential interruptions due to connectivity problems.

When complete, the screen shows 100% on both meters and **NO ERRORS**. The **Abort** button can stop the update if necessary.

If the Gateway was unable to locate a file on either the network or the memory card and cannot perform the update, it will display **COULD_NOT_GET_FILE** as shown in Figure 27.

Figure 28 depicts a firmware update using the web interface. The second panel shows an update that failed because the file was not available. (See page 31 for more information on the web interface.)

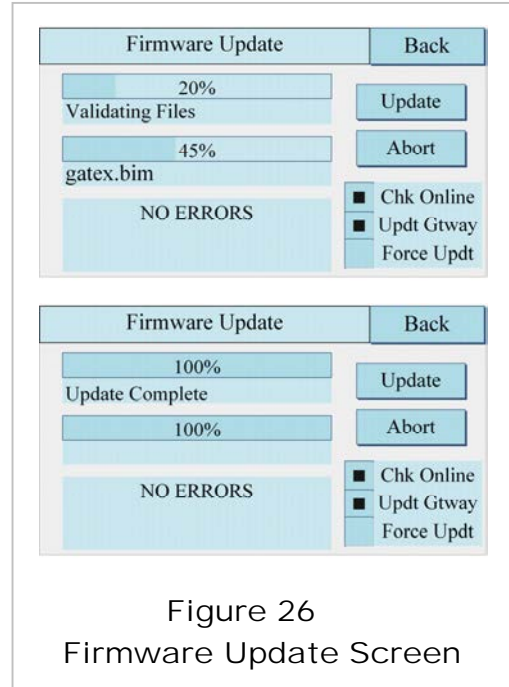

Figure 26
Firmware Update Screen

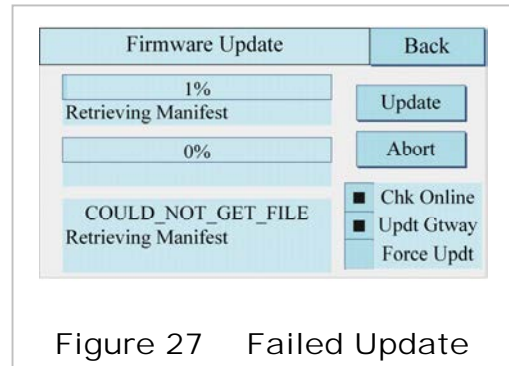

Figure 27 Failed Update

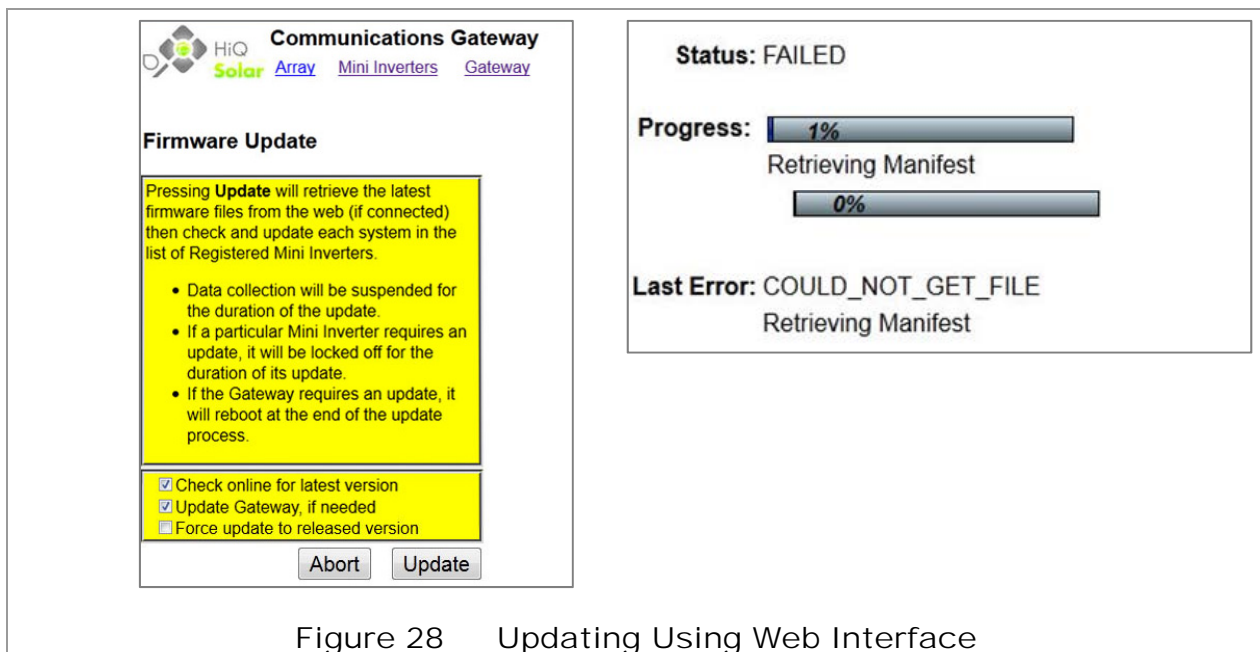

Figure 28 Updating Using Web Interface

Strings

The **Strings** button opens the **Strings** screen for a particular ProHarvest inverter (indicated by serial number under the **Inverters** tab and selected on the touch screen).

This screen displays the present status of both strings of PV modules on that inverter. It displays real-time voltage, current, and power. If no problems are detected, the screen reads **Healthy**. (**Fault** may indicate a ground fault or arc fault shutdown. **Unknown** may indicate a communications problem.)

The **Inverters** tab returns to the **Inverters** screen when selected.

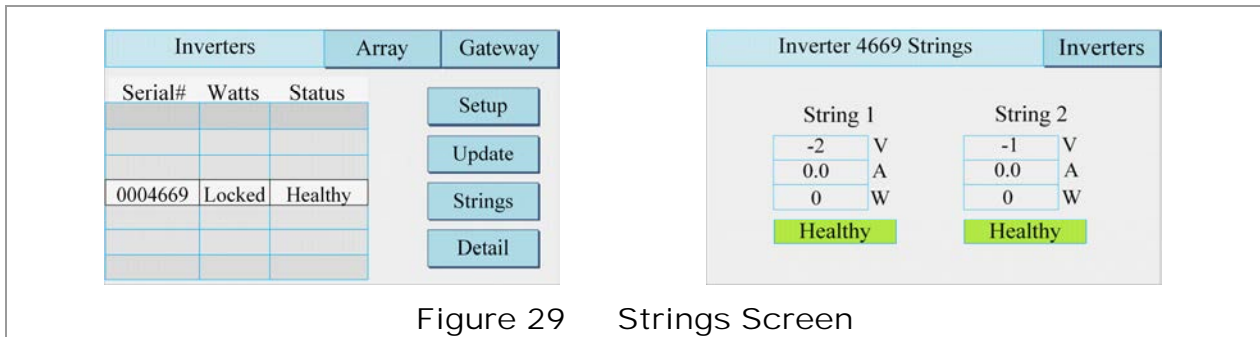

Figure 29 Strings Screen

Detail

The **Detail** button opens the **Detail** screen to display real-time AC information for a particular ProHarvest inverter (indicated by serial number under the **Inverters** tab and selected on the touch screen). It displays peak-to-peak voltage, RMS voltage, and power delivered by each phase.

If no problems are detected, the screen reads **Healthy**. See Figure 32 if **Fault** appears. **Unknown** may indicate a communications problem.

This screen also shows present PV power harvested (in watts) and lifetime harvest (in kilowatt-hours).

The **Inverters** tab returns to the **Inverters** screen when selected (as in Figure 29).

The **Power On**, **Off+Unlock**, and **Off+Lock** buttons on page 26 are used here for a single inverter.

The **Diag** button opens that inverter's diagnostic screen. If the status is not **Healthy**, one of two faults may appear. See Figure 32.

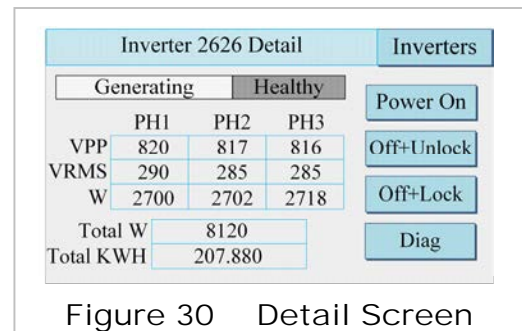

Figure 30 Detail Screen

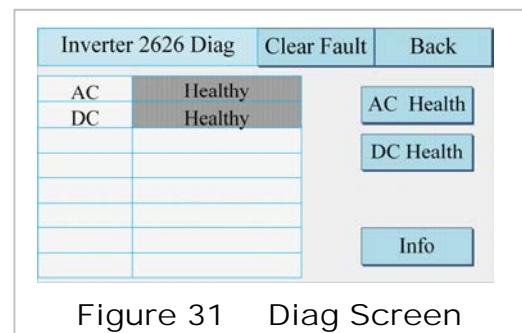

Figure 31 Diag Screen

NOTE: The **AC Health** and **DC Health** buttons are normally used only by OutBack Technical Support when troubleshooting the inverter.

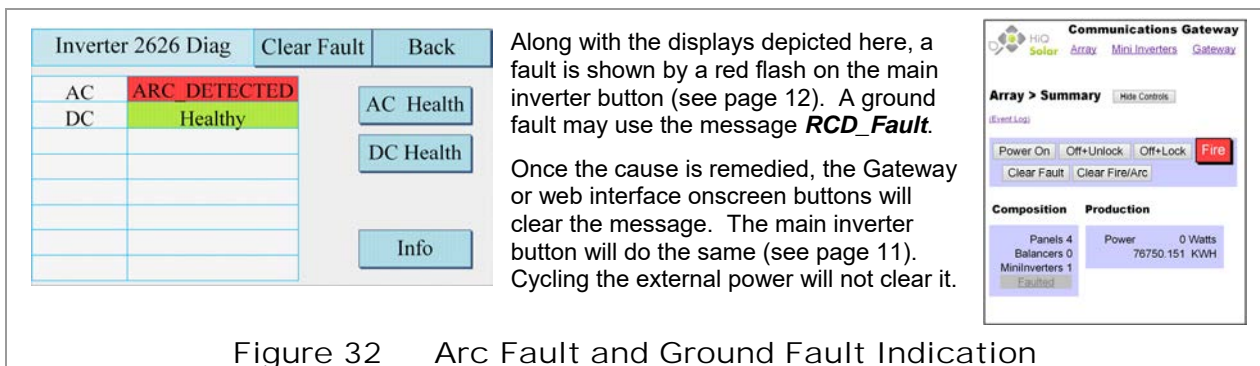

Figure 32 Arc Fault and Ground Fault Indication

Gateway Tab

The **Gateway** tab opens the **Gateway** screen, which provides settings and other critical networking information. This screen also features four buttons.

Network: This button opens the **Network Settings** screen. See page 31.

Clock: This button opens the **Set Clock** screen.

Screen: This button opens **Calibrate Screen**. This screen is used to adjust the appearance of the Gateway touch screen.

Diag: This button opens the **Gateway Diagnostics** screen. This screen is normally used only by OutBack Technical Support when troubleshooting the Gateway. The same is true for the PLC Diag, Beep, and Special buttons that appear here.

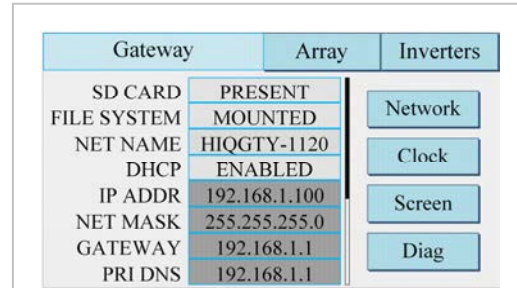

Figure 33 Gateway Tab

Network

The **Network** button opens the **Network Settings** screen. The items on this screen are addressed in **Accessing the Gateway Online** beginning on page 31.

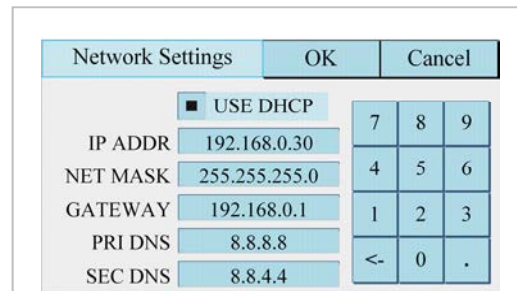

Figure 34 Network Button

Clock

The **Clock** button opens the **Set Clock** screen. This allows both the time and the date to be set. The Gateway uses a 24-hour clock. Note that the **ss** (seconds) item cannot be set even though its controls are shown.

Settings can be changed freely. However, any change causes the clock to immediately stop so that more changes can be made without conflict. Once the setting is complete, press the **Set** button to restart the clock and establish the changes.

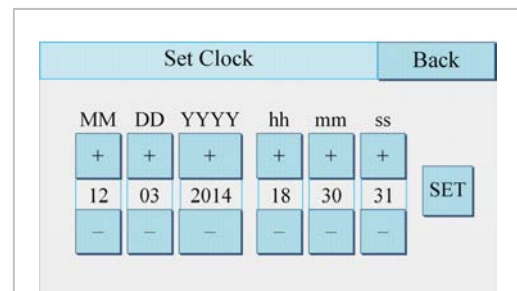

Figure 35 Clock Button

Screen

The **Screen** button opens **Calibrate Screen**. This allows the display to automatically recalibrated if necessary. Follow the instruction **Touch center of each cross or press CANCEL to cancel**. Pressing both crosses causes the message **Press OK to save calibration** to appear. Pressing either **OK** or **Cancel** will return the display to the Gateway screen.

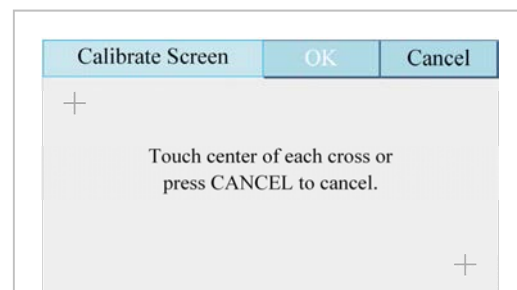

Figure 36 Screen Button

Accessing the Gateway Online

Online access requires the **Network Settings** screen, which is accessed with the Gateway Network button. This screen contains items that can be edited with the touch pad if necessary. These items are also visible once the online interface is established, as shown in Figure 38.

- o USE DHCP
This is a box that can be selected or unselected. It is selected by default.
- o IP ADDR
- o NET MASK
- o GATEWAY
- o PRI DNS
- o SEC DNS

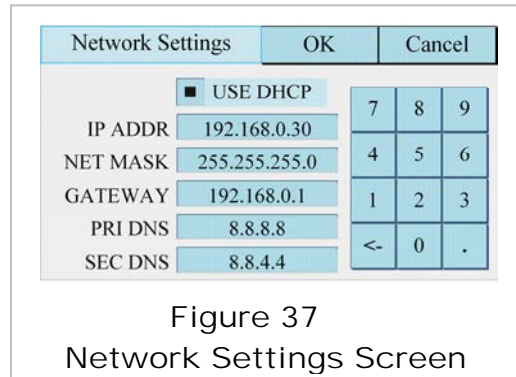

Figure 37
Network Settings Screen

Different methods of access to the Gateway are available.

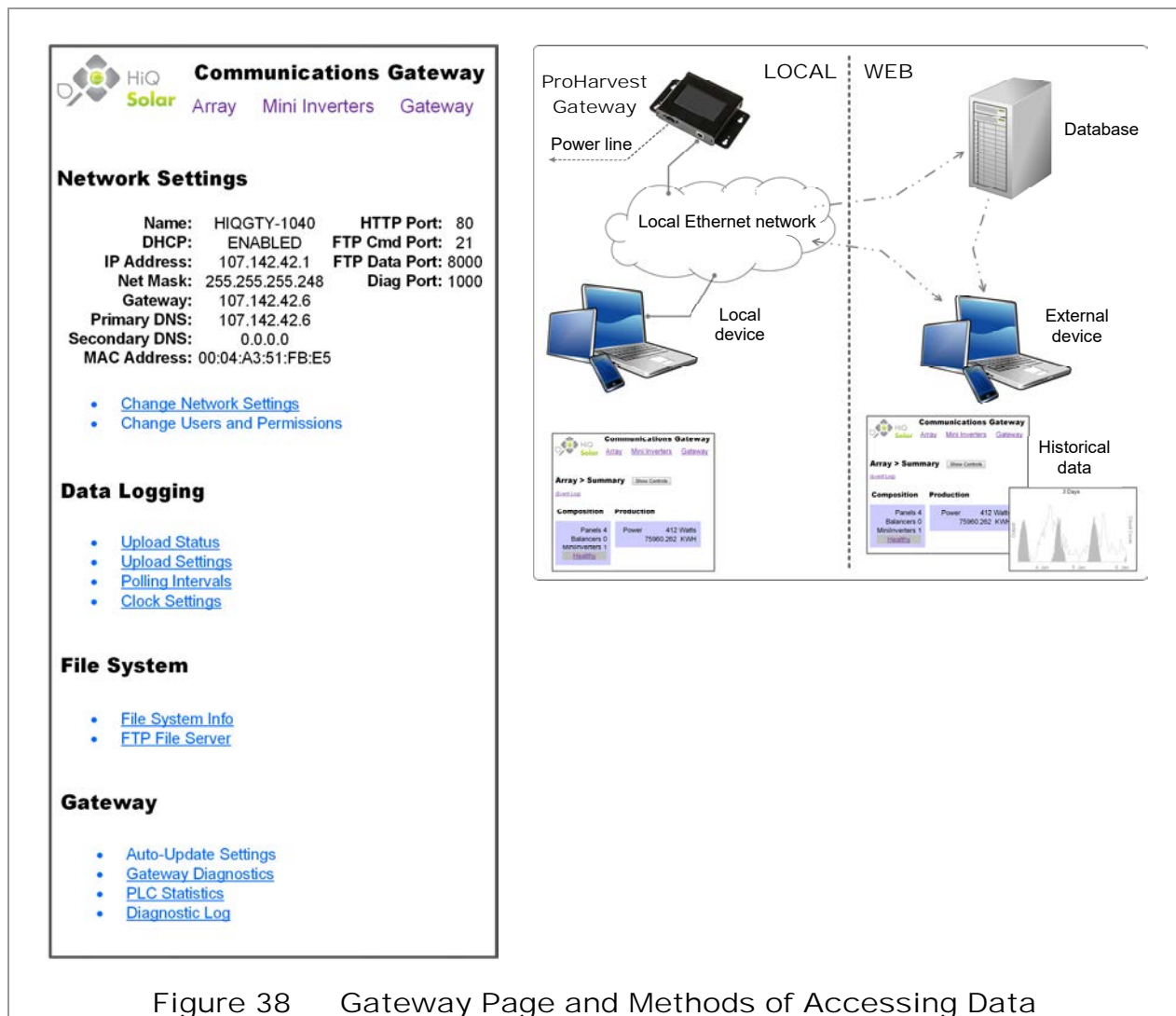

Figure 38 Gateway Page and Methods of Accessing Data

Gateway Access Inside a Local Network

To access locally from a Windows device:

1. Select the **Gateway** tab. Use the **Network** button to open the **Network Settings** screen as shown in Figure 39.
2. Open a web browser. Type the **NET NAME** into the address bar. In Figure 39, this is **HIQGTY-1120**.

The listed IP address can also be used. In Figure 39 the address is **192.168.1.100**, but this will vary². This will bring up the web login screen. Unless otherwise altered, the following will apply (case sensitive):

Username: admin

Password: HiQSolar

The home screen for that particular Gateway will appear as shown in Figure 40.

To access locally from Mac OS computer device (including iPads & iPhones):

Follow the steps above, with the following exception:

- o **NET NAME** is not supported. The IP address (the contents of **IP ADDR**) must be entered into the browser address line.

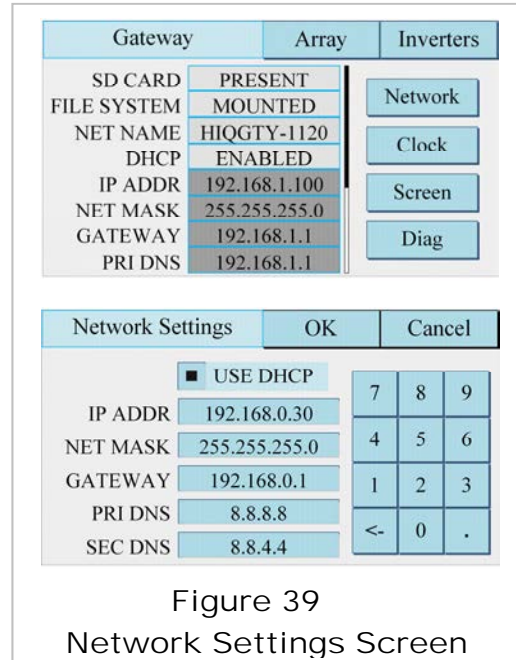

Figure 39
Network Settings Screen

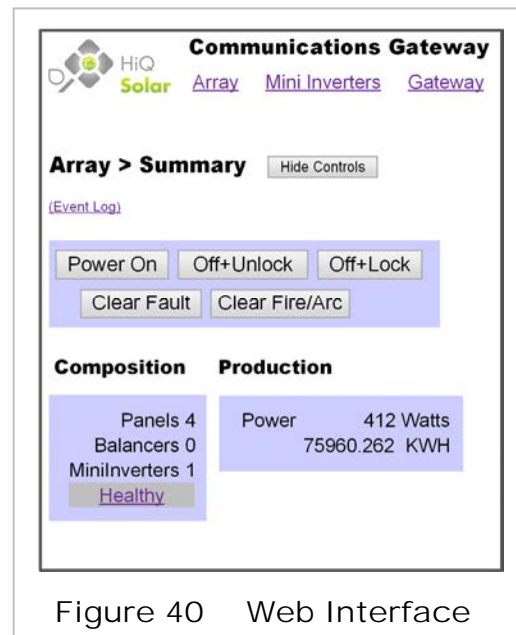

Figure 40 Web Interface

² Note that this IP address is for the web page provided by the web server. The network connection the Gateway uses to communicate to a local router is the one further down the list labeled **GATEWAY**. In Figure 39 this is 192.168.1.1.

Webpage Menu Map

The interface screen has three tabs: **Array**, **Mini Inverters**, and **Gateway**.

Array (A) is similar to the **Array Summary** screen on page 26. (It shows the full system, not just the PV array.) This screen shows the same controls (B) as on page 26.

NOTE: A smartphone can control this system when local network settings allow. Because phone screens are small, the wrong controls could accidentally activate or disable important functions. To avoid this, some screens have a button (C) to Show or Hide Controls.

Mini Inverters (D) shows items similar to the **Inverters** screen on page 27, including DC and AC data. These controls can also be hidden (E).

Gateway (F) shows items similar to the **Gateway** screen on page 30.

Figure 41 Gateway Webpage Menu Structure

Gateway Access Outside a Local Network

LAN-side Configuration

DHCP has a lease time after which it requests renewal, causing problems if a different IP address is assigned. To keep the same IP address continuously, several methods may be used.

- o Keep the Gateway in DHCP but force the router to allocate the same IP address each time. This is generally the most desirable way if supported by the router.

If this functionality is supported by the router it might look like Figure 42, here called **DHCP Reservation**.

- o Change to a fixed IP address.

Router capabilities and user interfaces vary. This example uses a particular Cisco router. In Figure 42, the router has a defined range of 50 IP addresses it has reserved for DHCP allocation (from 100 to 149 for the last field in the address).

The **DHCP Reservation** screen for this router is depicted in Figure 43. It allows examination of the devices currently logged on, and the option of assigning an address in the Gateway's allowed range.

Alternatively, a fixed IP address can be assigned outside the DHCP range. (Figure 43 shows the example address **192.168.1.37** being assigned.)

If this is done, the Gateway must also be configured. On the **Network Settings** screen, unselect the USE DHCP box. (See Figure 34 on page 30.)

For the other settings:

- o **IP ADDR:** Assign the IP address as noted.
- o **NET MASK:** Usually remains at **255.255.255.0**.
- o **GATEWAY:** Usually entered from the router screen.
- o **PRI DNS:** Usually entered from the router screen.
- o **SEC DNS:** Usually remains at **0.0.0.0**.

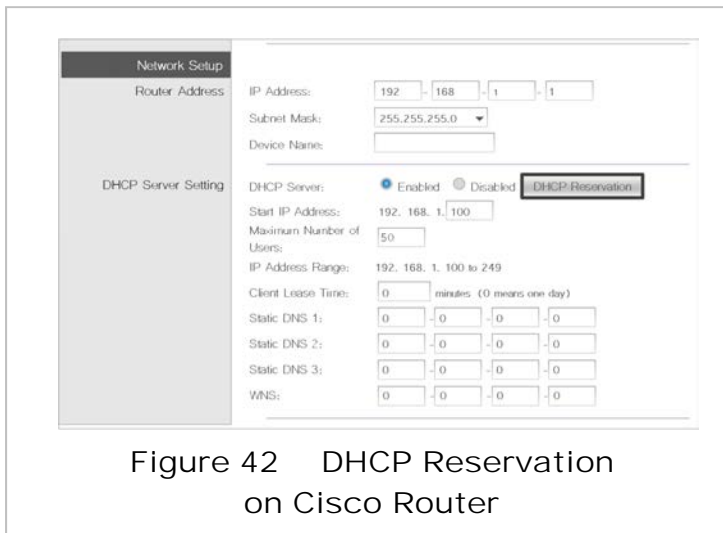

Figure 42 DHCP Reservation on Cisco Router



Figure 43 Assigning IP Address on DHCP Reservation Screen

WAN-side Configuration

In the Cisco router used as an example here, the **Applications and Gaming** screen is used to open a port for outside communication. (See Figure 44.) The aim is for communication to pass through the router, although there will usually be some translation of port labels between what the Gateway expects and what is presented to the outside world on the WAN side of the router.

There are four possible ports required to fully access the Gateway and ProHarvest inverters remotely. Access to the control web page alone requires only the setup of the first of those listed in Table 4.

Table 4 Port Numbering Assignments

Label	Function	External (customer-changeable as required)	Internal (what the Gateway expects to see)
HTTP	Allows access to the Gateway web page	8100	80
FTPC	FTP Control – allows access to the Gateway memory card and logs	2100	21
FTPD	FTP Data – the return port for files requested using FTPC to be transmitted through	8000 (Use this setting only)	8000
Diag	Diagnostic - Low level system access for operations such as firmware updates	1000 (Use this setting only)	1000

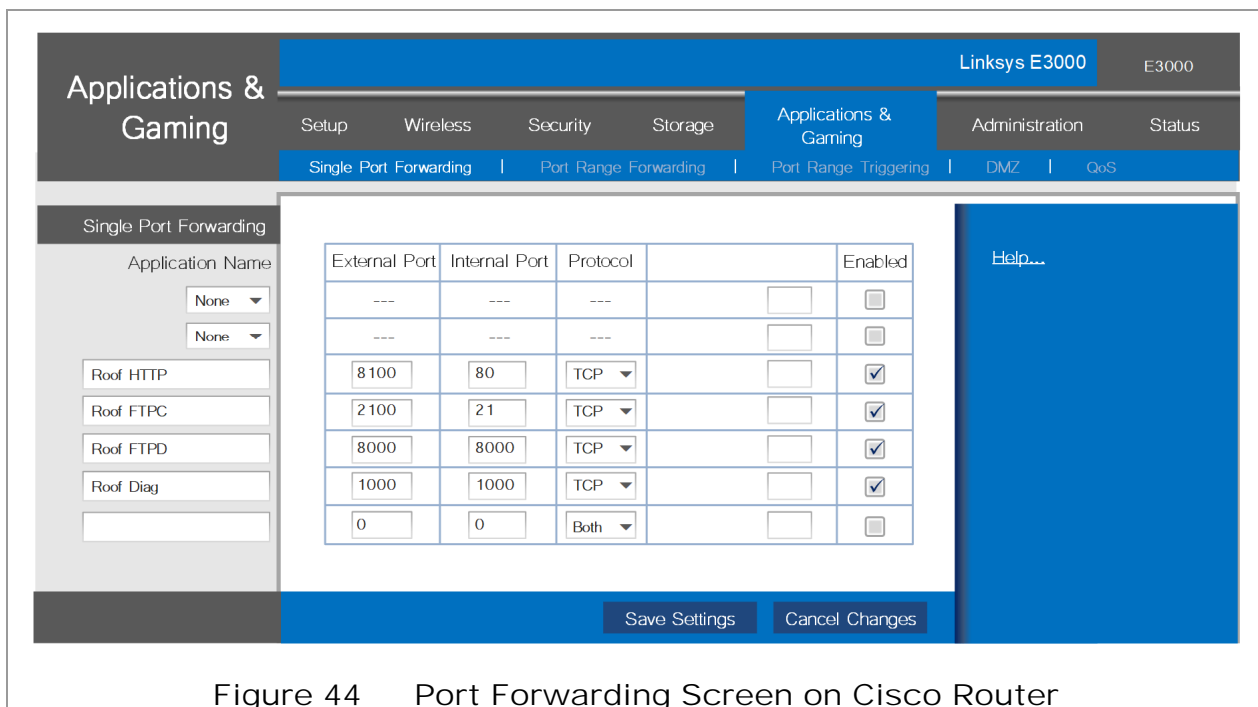

Figure 44 Port Forwarding Screen on Cisco Router

Note that not all routers offer port reassignment as described here. However, having different external port numbers is not strictly necessary. It is suggested as an extra security precaution to avoid using the well-known port assignments for web (80) and FTP (21) on the general Internet. The Gateway's web and FTP servers are both password protected, so the risks are low. In a case where no port forwarding is available, the Gateway direct port numbers (80, 21, 8000, 1000) would be used without specifying different external ports for 80 and 21.

Utility Protective Functions (Webpage only)

The ProHarvest inverter system is capable of operating beyond normal AC grid ranges when required to do so by the operating utility company.

Changes in this area must only be carried out with the express written permission of the utility company. Only values specified by the utility company may be set.

Changes are made through the web pages and cannot be accessed from the Gateway touch screen. When logged into a particular Gateway through the web portal, type the following into the browser URL address bar after the serial number: /SAFETYLIMITS.htm (capitalization is important here). This will bring up the screen shown in Figure 45.

An example is <http://hiqgty-1020/SAFETYLIMITS.htm>.

To communicate with a particular inverter on that Gateway, enter the individual serial number into the **Serial #** field. Press the **Get** button to begin communication with that particular inverter. This will populate its present values in the web page.

When desired changes have been completed, press the **Set** button to write the new values back to that same inverter.

Available ranges are given in the **Specifications** section near the end of this document.

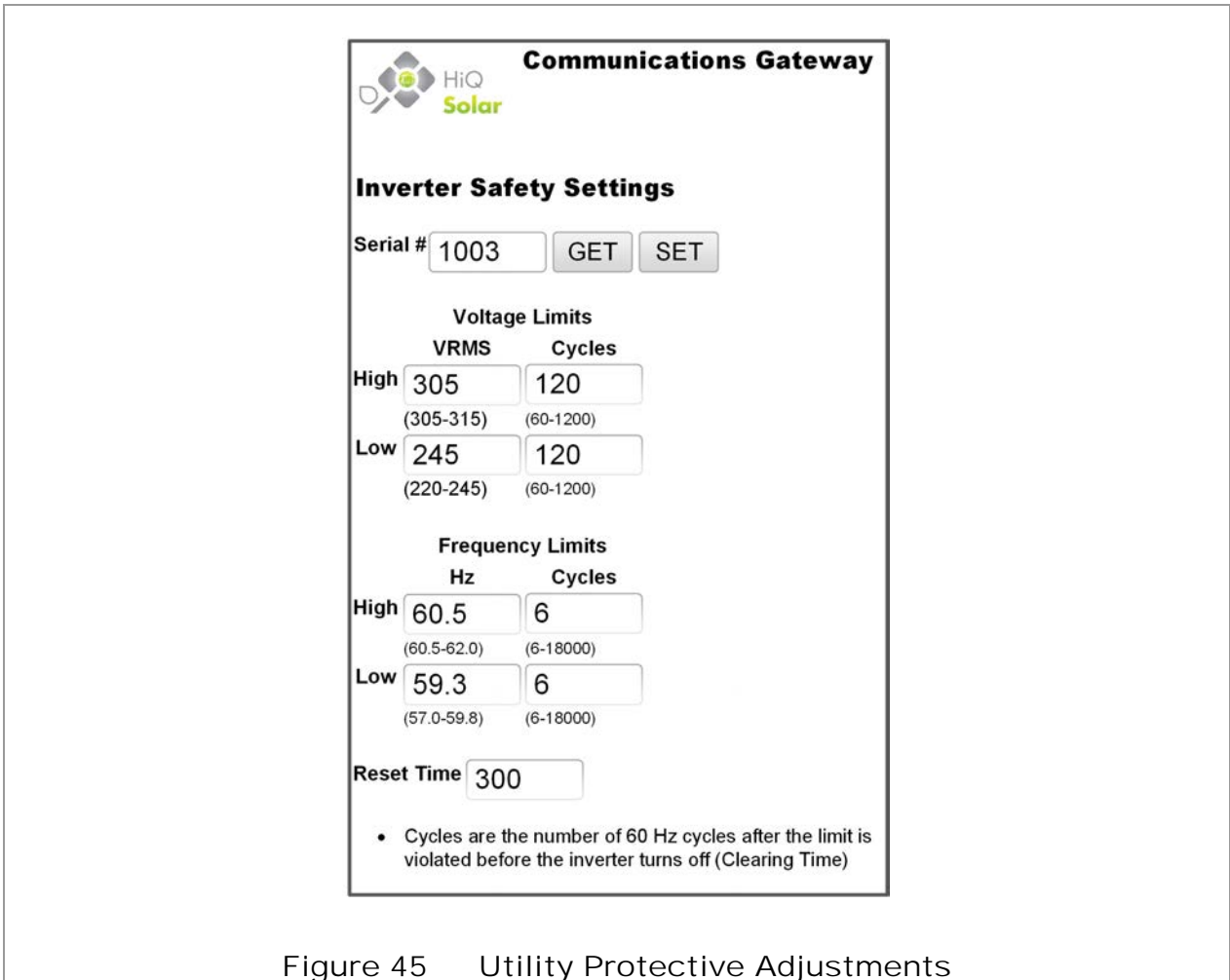
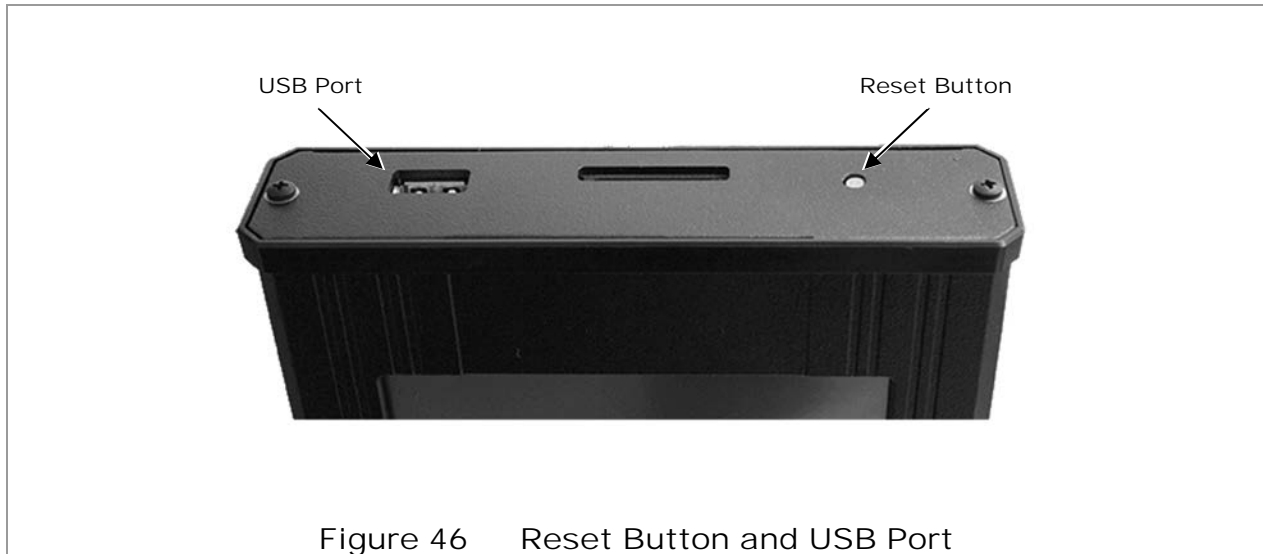

Figure 45 Utility Protective Adjustments

Other Gateway Features

The Gateway has several features that are not usually accessible after installation. These include a USB port and a button marked **RESET**.

- o The **RESET** button performs a full system reboot, the same as if both AC and DC power had been removed.
- o The USB port is not functional at this time.





Troubleshooting

General Troubleshooting

The primary way of troubleshooting a system is to investigate using the Gateway. The Gateway can be viewed on its touch screen interface, or by accessing it using a web browser. Assuming the issue is not with communications, browser access allows the use of a mobile device such as a phone while physically at the installation location.

As detailed later, the inverter has a set of LED indicators that can also provide status. These messages are summarized below.





Troubleshooting Topics

The troubleshooting section is divided up as follows:

- o LED indicators
- o Overview of possible issues
- o Symptoms and causes
- o More details on selected issues

LED Indicators

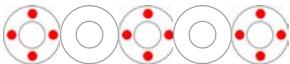
Table 5 Inverter States (Button)

Inverter Indicator State	Button Indication
Green solid 	<ul style="list-style-type: none"> o Powered up o Not generating (5-minute timer may be running) o No faults
Green, left-right alternating flash 	<ul style="list-style-type: none"> o Power-on self-test (will take <1 minute)
Green, clockwise circular flash 	<ul style="list-style-type: none"> o Powered up o Generating o No faults
Red rapid flash 	<ul style="list-style-type: none"> o Fault condition <p>Examples:</p> <ul style="list-style-type: none"> • Arc has been detected • No grid
Green flash, mostly on 	<ul style="list-style-type: none"> o Off & Locked o Disabled
Green flash, mostly off 	<ul style="list-style-type: none"> o Sleeping o Not generating

Overview of Possible Issues

Letters on the right (such as A) refer to issues and symptoms listed in the following sections.

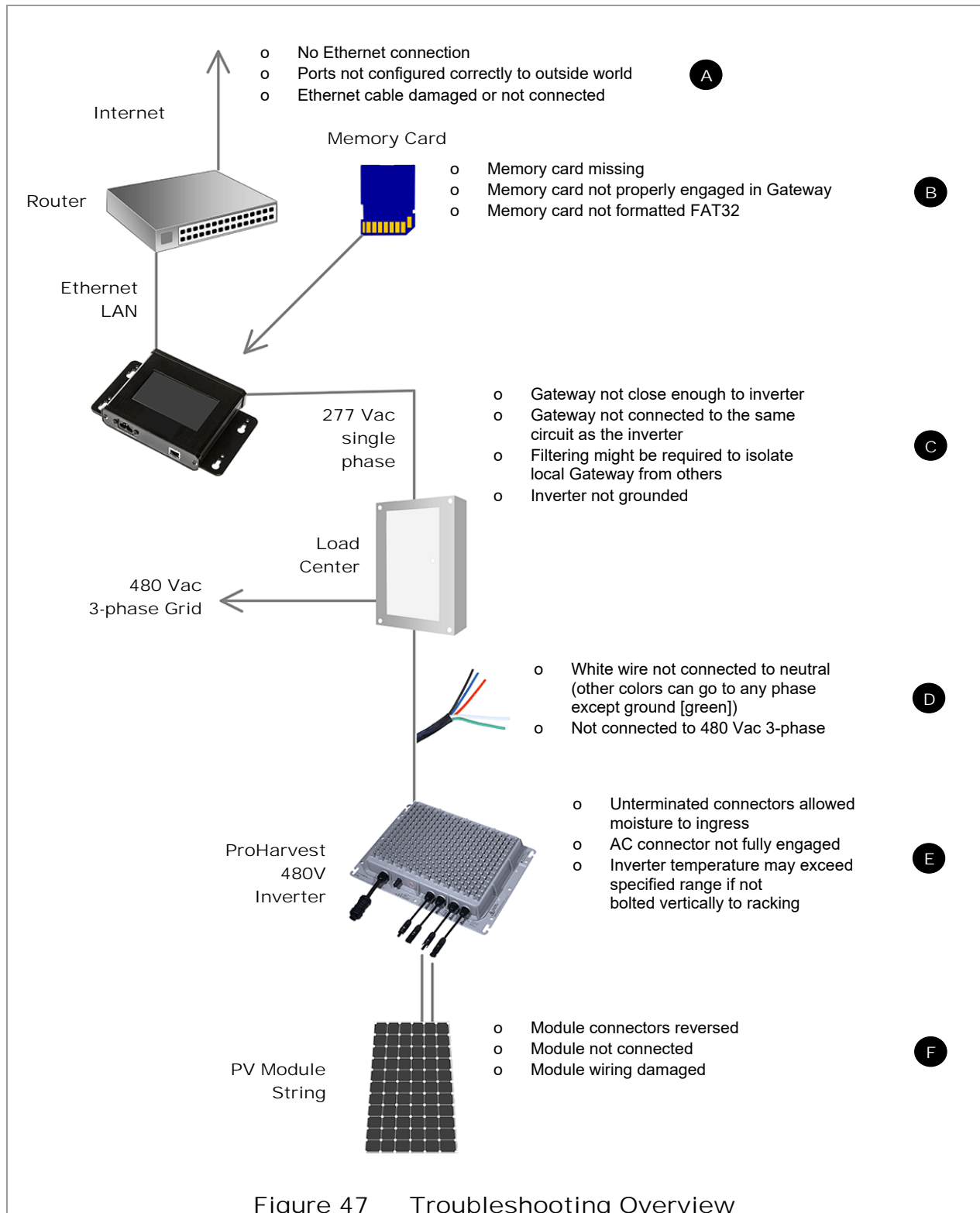

Figure 47 Troubleshooting Overview

Symptoms and Causes

Letters next to individual problems (such as D) correspond with general locations pointed out in the **Overview** on page 40.

Table 6 Symptoms and Corresponding Issues

Symptom		Possible Cause
Button	Touch Screen (also web interface in most cases)	
Red flash (fast)	AC section of display has no reading	o AC output of inverter not connected to grid (D)
		o AC connector not fully engaged (D)
	Moisture	o One phase of AC grid not connected (D) o Connected to wrong voltage system (for example, 208 Vac 3-phase) (D)
	Arc Fault	o Moisture has been allowed into the system, perhaps because unused connectors have been left un-terminated (E) (F) o Arc Fault NOTE: This condition will automatically attempt to reset itself after 6 hours.
Solid green	No production	o Insufficient PV energy; no malfunction
N/A	Panel figures missing statistics	o Missing PV module (F) o Faulty wiring or connectors not fully engaged (F)
	Less power output than expected	o Inverter in direct sun and temperature range exceeded, causing output to be reduced to maximize lifetime (E)
	SD indicator on Array Summary screen shows red	o Memory card not fully engaged (B) o Memory card not formatted as FAT32 (B) o Memory card missing (B)
	AC indicator on Array Summary screen shows red	o Gateway not connected to the same AC circuit as the inverter(s) (C) o Gateway placed too far from the inverter(s) (C) o Filtering present on the grid interfering with communication (C) o Neutral (white or gray) wire connected to a phase (D) o Inverter not grounded (C)
	NET indicator on Array Summary screen shows red	o Ethernet cable not connected (A) o Router external ports/ firewall not set up correctly (A)

More details by topic

This section provides more details on the lettered topics depicted on page 40. See page 26 for more information on the **Array Summary** screen shown here.

A. Network Issues

- o No Ethernet connection
- o Network router not configured correctly
- o Router external ports / firewall not set up correctly

Any of the above issues can cause the Gateway's **NET** indicator to turn red.

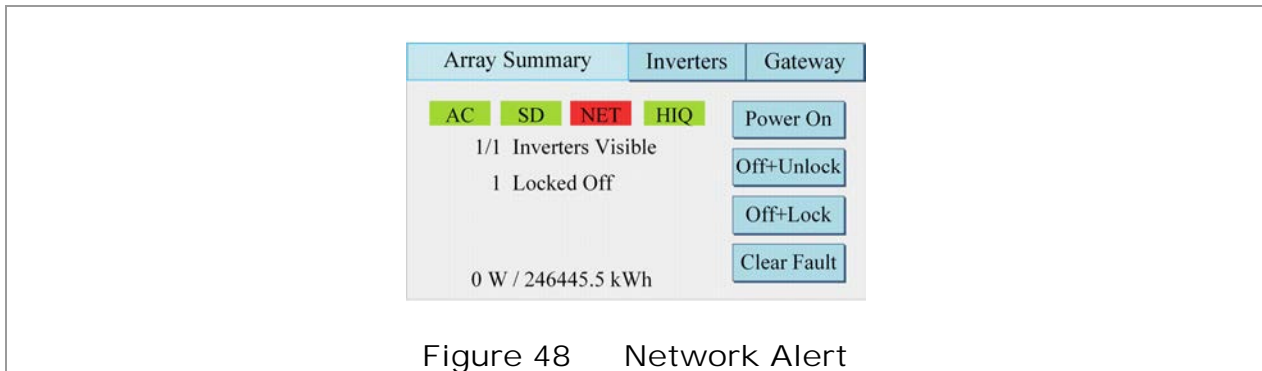



Figure 48 Network Alert

B. Memory Card Issues

Logging of long-term performance data is saved to the memory card that was supplied with the Gateway. Note that the card is not required for the system to operate, only to retain historical information. If the card is in place but not fully engaged, the **SD** indicator will turn red.

The card is formatted with the FAT32 file system. If a memory card is needed that is different than the one supplied, it will need to be formatted similarly.

	IMPORTANT:
	Gateway communications require the memory card to be in place. The Gateway will not communicate if the card is not present.

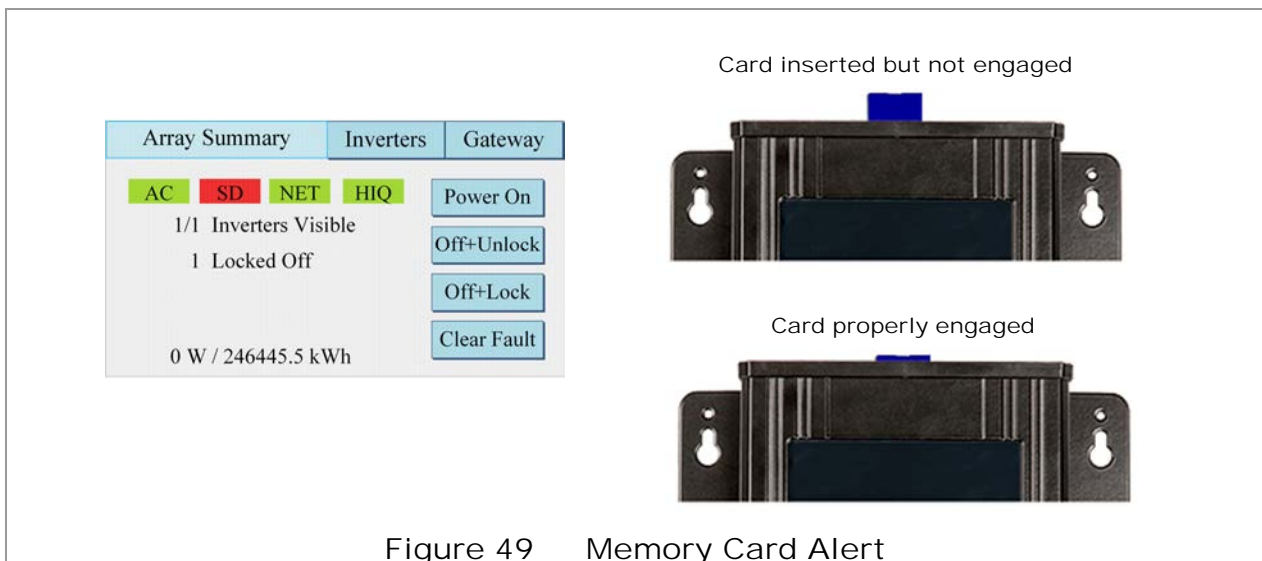

Figure 49 Memory Card Alert

C. Gateway-to-Inverter Connectivity Issues

- The Gateway is wired into an unrelated AC circuit
- The Gateway is too far away from inverter(s)
- The Gateway is the wrong side of filtering on the AC circuit
- Filtering present on the utility grid interfering with communication

The Gateway connects to local inverters using Power Line Communications (PLC). For communication to work, the Gateway must receive a strong enough signal to exceed any line noise. It must be on the local side of an isolation transformer. It must be on the same electrical circuit as the PV system. This is not always easy to establish in a typical company electrical closet with many different circuits present.

Assuming the Gateway is on one phase of the correct PV system circuit, then issues are likely to arise if the signal strength is low. Issues are also likely to arise if equipment between the Gateway and PV system is interfering with or filtering the signal. In either case moving the Gateway closer to the PV system is likely to be the best answer.

It is also possible that two Gateways (or other inverter control devices from other manufacturers nearby) are interfering with each other. In this case an isolating filter to separate the inverter communications from the outside world might be required.

Note that a failure to establish communications can also occur if the neutral (white or gray) wire is connected incorrectly to one of the phases as discussed in the next section.

D. AC Wiring Issues

- AC output of inverter not connected to grid
- AC connector not fully engaged
- One phase of AC grid not connected
- Neutral (white or gray) wire connected to a phase instead of neutral
- Connected to wrong voltage system (208 Vac 3-phase)

The inverter automatically senses the phases connected to it. When wiring the system to the utility grid it does not matter which of the red, blue or orange wires are connected to which phase. However, the AC indicator will turn red if the neutral (white or gray) wire is connected to one of the phases. This is the same fault that will appear if one of the three phases is disconnected. These conditions will not damage the inverter but should be corrected.

If one of the phases is not connected, the web and touch screen views will show one of the AC phases faulted rather than all three.

If the neutral is connected to one phase, the Gateway PLC may not work.

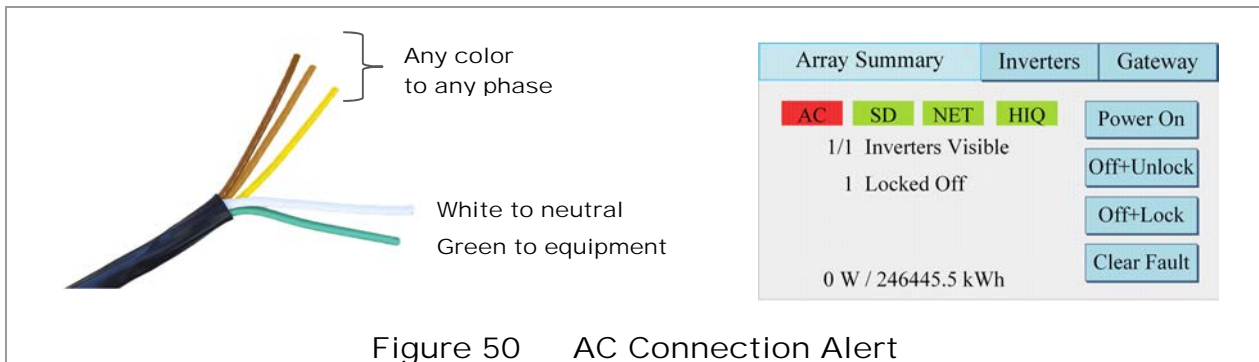

Figure 50 AC Connection Alert



CAUTION: Equipment Damage

If the inverter is connected to the wrong voltage system, such as 208 Vac 3-phase, damage is likely to result. The system will need to be returned to the factory.

E. Inverter Installation Issues

- o Underminated connectors allowed moisture to ingress
- o AC connector not fully engaged
- o Temperature range exceeded (possibly from direct sun exposure), causing output to be reduced due to high internal temperatures. This protective feature helps to extend the lifetime of the inverter.

The inverter is NEMA6 rated and very robust. To maximize reliability and performance for the longest lifetime it should be mounted vertically in the shade and bolted to metal racking if available. However, it can be ballast-mounted in the shade. If the device is placed in a situation where it exceeds its rated temperature range, it will reduce output power slightly until it is safely back within the operating temperature range.

As with all such devices, NEMA6 waterproof operation requires that all connectors, whether used or unused, be properly terminated. Any connector left open may allow moisture to enter, causing the unit to eventually fail.

F. PV Module Wiring Issues

- o PV module not connected
- o PV module wiring fault
- o Faulty wiring or connectors not fully engaged
- o Missing PV module

These are generally self-explanatory issues of connectors not engaged or damaged wiring.



Specifications

Specification Tables

Table 7 General Specifications

Specification	Value
Peak efficiency	98.2 %
CEC efficiency	97.5 %
AC Voltage Trip Limit Accuracy	±2.7 Vac
Frequency Trip Limit Accuracy	0.05 Hz
Trip Time Accuracy	±34 ms or 1%
Weight	13.6 kg (30.6 lb.)
Operating temperature range	-40 to +65 °C (-40 to +150 °F)
Power consumption standby/ night	<8.3 W
Cooling	Natural convection, no cooling fan
Communication	Power Line Communication
Environmental rating	Outdoor / rooftop, NEMA type 6

Table 8 Power System Specifications

Specification	Value
DC Input (2 identical inputs)	
Maximum open circuit voltage per String, V_{oc}	1,000 Vdc
Full power MPPT range, per string	450-850 Vdc
PV start voltage	200 Vdc
DC allowable stacking ratio (total, 2 inputs combined)	Must not exceed 4.0 under any circumstances ³
DC maximum input current, per DC input	12 Adc
DC maximum source short circuit current	30 Adc
DC maximum input source backfeed current to input	0 Adc
DC disconnect means	The DC connector has been evaluated and approved for use as the load-break disconnect required by the NEC ⁴
AC Output	
AC maximum continuous output power to 40°C	9.975 kW _{ac} max
AC de-rate with temperature, 40 to +65°C	-175W/°C
AC nominal output current, per phase	12.0 Aac
AC maximum continuous output current, per phase	12.0 Aac
AC maximum output overcurrent protection	80 Aac
AC 3-phase system compatibility	480 Vac Wye, 3 phases, neutral and ground
AC voltage ⁵ , phase to phase (min/nom/max)	422 / 480 / 528 V _{rms}
AC voltage ⁵ , phase to neutral (min/nom/max)	244 / 277 / 305 V _{rms}
AC operating frequency ⁵ (min/nom/max)	58.5 / 60 / 62 Hz
AC reconnect time delay ⁵ (min/default/max)	1 / 300 / 1000 seconds
AC synchronization in-rush current	0 Aac
AC minimum wire gauge for the grid connection	#14 AWG
Maximum output fault current and duration	12 Aac for 10 ms
Power Factor ⁵	≥0.99 (adjustable: 0.8 leading to 0.8 lagging)
AC output waveform	True sinewave
AC disconnect means	The AC connector has been evaluated and approved for use as the load-break disconnect required by the NEC ⁴ .

³ Stacking: On the DC side of the inverter, each input limits at 6 kW and/or 12 Adc, and the combined total AC output is limited to 9.975 kW. Higher DC STC string powers may be applied, the inverter will limit as described above. Total stacking for inverter must not exceed 4.0 under any circumstances

⁴ NEC section 690.17, allowed by the exception of meeting requirements specified in 690.33

⁵ These parameters can be adjusted as required by the Utility, see following page for ranges.

Specifications

Table 9 Gateway Specifications

Specification	Value
AC input voltage, min/nom/max	244/277/305 Vac
AC frequency, min/nom/max	59.3/60.0/60.5 Hz
Operating ambient temp range	-20 to +50 °C
Power consumption	1.5 W typical (4 W max)
Mounting, environmental rating	Indoor - NEMA 1
Memory card	SD compatible, 4-32GB tested, FAT32 formatted
Communication with inverter	Proprietary Power Line Communication
LAN connection, Ethernet	10/100BASE, RJ45 8P8C modular plug
Limited warranty	10 years, optionally extendable
Compliance, certifications	UL 60950-1, CSA C22.2 No. 60950-1, FCC Part 15 ⁶
Weight	1.3 lb

Table 10 Operating Parameters

Condition		Unit	Default	Min	Max
AC Voltage Ride-through	High, Region 2	Voltage ($V_{rms, L-N}$)	332.4	332.4	360.1
		Time (seconds)	0.16	-	-
	High, Region 1	Voltage ($V_{rms, L-N}$)	304.7	304.7	332.4
		Time (seconds)	13	1	13
	Low, Region 1	Voltage ($V_{rms, L-N}$)	243.8	193.9	243.8
		Time (seconds)	21	2	21
	Low, Region 2	Voltage ($V_{rms, L-N}$)	193.9	138.5	193.9
		Time (seconds)	11	2	11
	Low, Region 3	Voltage ($V_{rms, L-N}$)	138.5	83.1	138.5
		Time (seconds)	1.5	0.16	5
Frequency Ride-through	High, Region 2	Frequency (Hz)	62	62	64
		Time (seconds)	0.16	0.16	1000
	High, Region 1	Frequency (Hz)	62	60.1	62
		Time (seconds)	300	0.18	1020
	Low, Region 1	Frequency (Hz)	58.5	57	59.9
		Time (seconds)	300	0.18	1020
	Low, Region 2	Frequency (Hz)	57	53	57
		Time (seconds)	0.16	0.16	1000
Ramp Rate	Soft Start Ramp Rate	% $I_{nominal}$ /second	100	0.1	100
	Normal Ramp Rate	% $I_{nominal}$ /second	100	0.1	100
Volt/VAR	Inflection Point 4	Voltage ($V_{rms, L-N}$)	332.4	304.7	332.4
		VAR	-1000	-6000	0
	Inflection Point 3	Voltage ($V_{rms, L-N}$)	290.9	277	304.7
		VAR	0	0	0
	Inflection Point 2	Voltage ($V_{rms, L-N}$)	263.2	249.3	277
		VAR	0	0	0
	Inflection Point 1	Voltage ($V_{rms, L-N}$)	221.6	193.9	249.3
		VAR	1000	0	6000
	Specified Reactive Power	VAR	0	0	6000
	Response Time	Time (seconds)	1	0.25	1000
Frequency/Watt	Start Frequency of Function	Frequency (Hz)	60.036	60.017	61
	Endpoint Frequency of Function	Frequency (Hz)	63.036	61.817	64
	Power Curtailment	% Watts	100	0	100
Volt/Watt	Start Voltage of Function	Voltage ($V_{rms, L-N}$)	290.9	290.9	301.9
	Endpoint Voltage of Function	Voltage ($V_{rms, L-N}$)	304.7	293.6	304.7
	Power Curtailment	Watts	20	0	100

⁶ This equipment has been tested and found to comply with the limits for a Class B digital device, pursuant to part 15 of the FCC Rules. These limits are designed to provide reasonable protection against harmful interference in a residential installation. This equipment generates, uses and can radiate radio frequency energy and, if not installed and used in accordance with the instructions, may cause harmful interference to radio communications. However, there is no guarantee that interference will not occur in a particular installation. If this equipment does cause harmful interference to radio or television reception, which can be determined by turning the equipment off and on, the user is encouraged to try to correct the interference by one or more of the following measures:

- Reorient or relocate the receiving antenna.
- Increase the separation between the equipment and receiver.
- Connect the equipment into an outlet on a circuit different from that to which the receiver is connected.
- Consult the dealer or an experienced radio/TV technician for help.

Regulatory Specifications

Certifications

- o UL1741 — Inverters, Converters, Controllers and Interconnection System Equipment for Use With Distributed Energy Resources
- o ANSI/UL 1998, Software in Programmable Components
- o IEEE 1541, Interconnecting Distributed Resources With Electric Power Systems
- o IEEE 1541.1, Conformance Test Procedures For Equipment Interconnecting Distributed Resources With Electric Power Systems
- o CAN/CSA C22.2 No. 107.1, General Use Power Supplies
- o This product has been issued UL Certificate of Compliance No. 20181119-E475257

Footprints

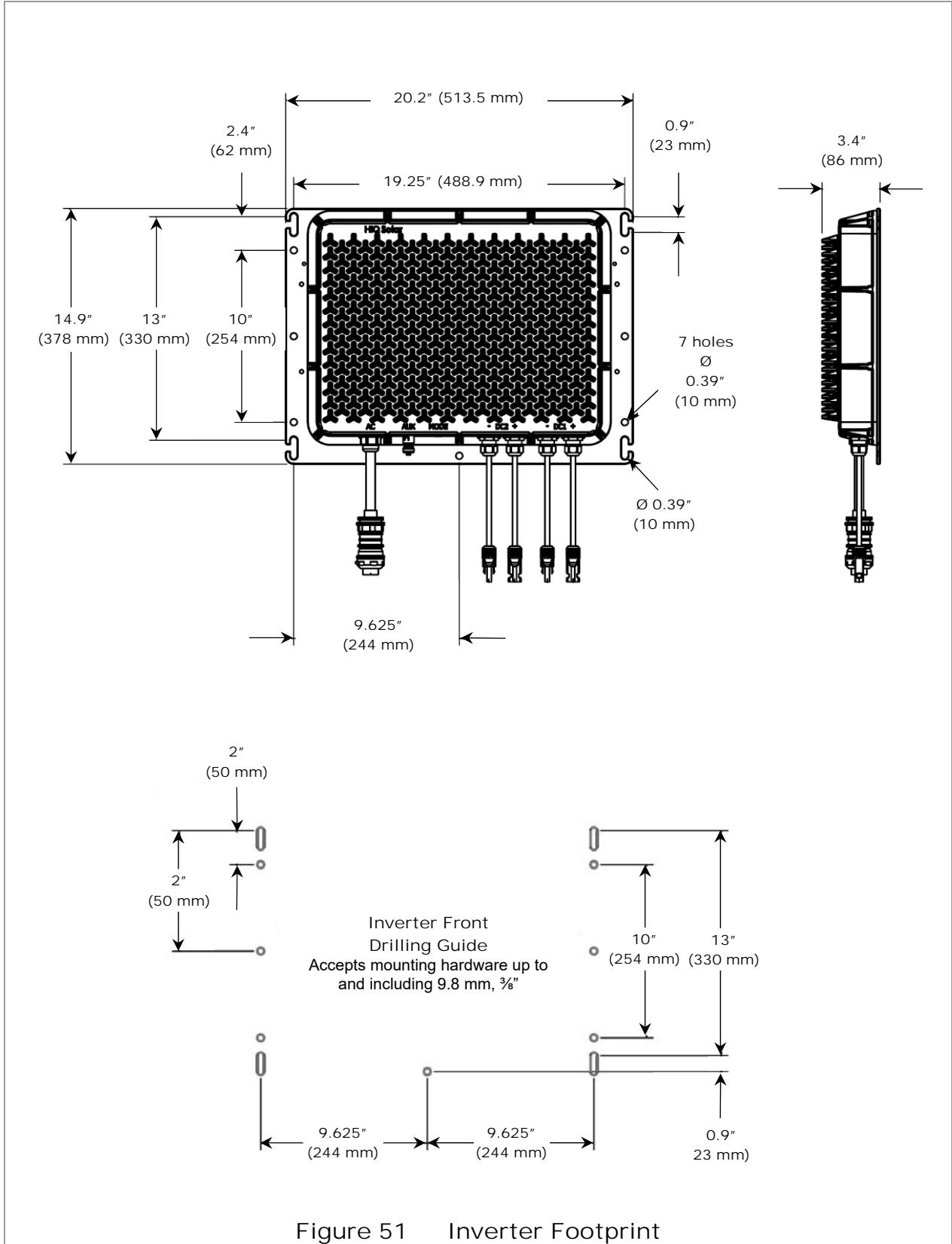

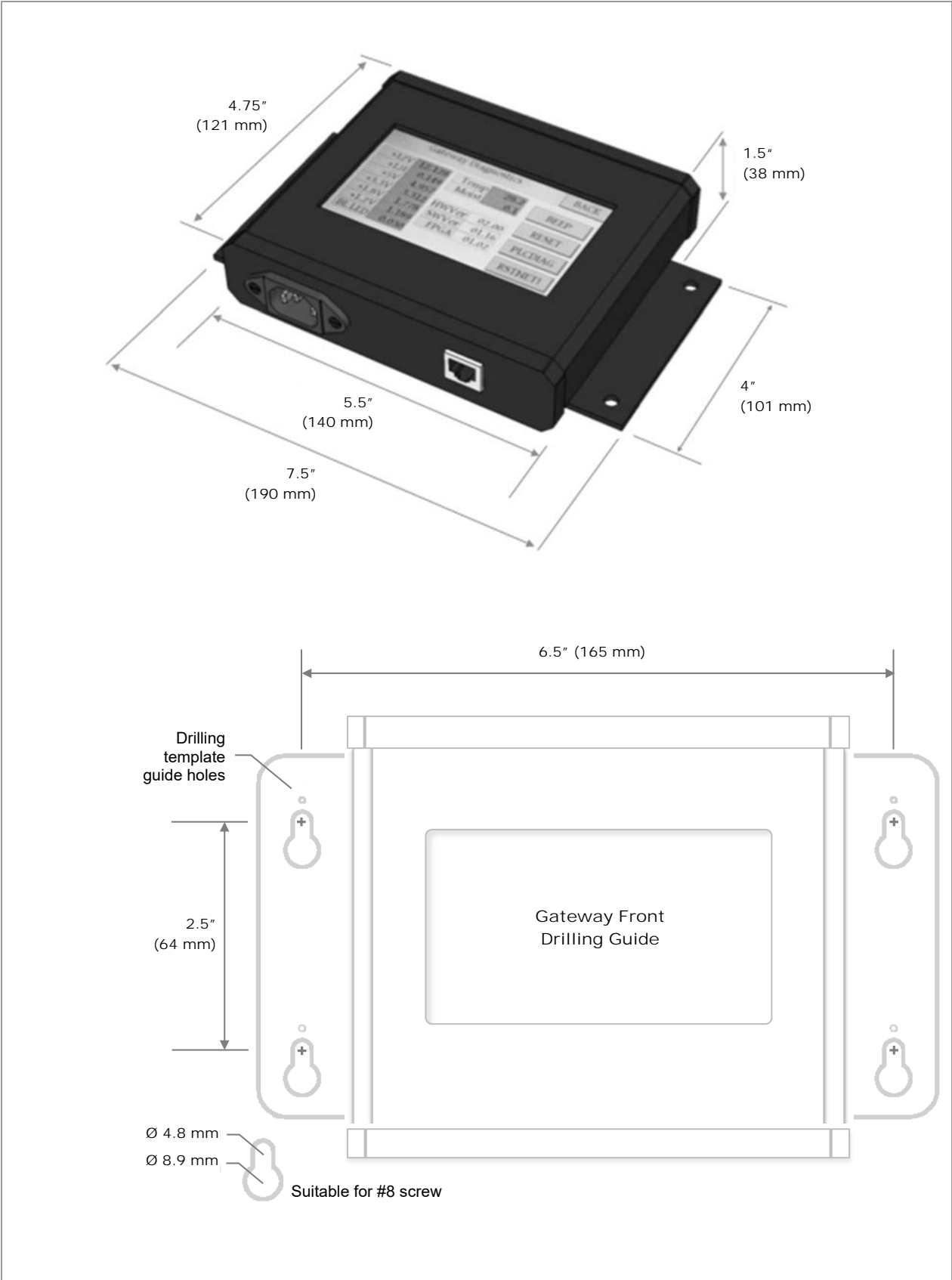

This page intentionally left blank.

This page intentionally left blank.



Corporate Headquarters
17825 – 59th Avenue N.E.
Suite B
Arlington, WA 98223 USA
+1.360.435.6030