

尺寸:A5
 材質:一般書寫紙(白)
 印刷:黑白雙面印刷
 原料號:75-1000-0165_A0
 新料號(加版本):75-1000-0226_A1
 A1修改內容:封面圖片更新
 ※ 無庫存、無打樣、故不變新料號
 ※ 以上敘述非本文

COTEK

COTEK
 正式文件，妥善保存

ST Series

Pure Sine Wave Power Inverter User's Manual

COTEK	
出圖人	確認章
研發部 2011.01.27 簡世宗	張春成

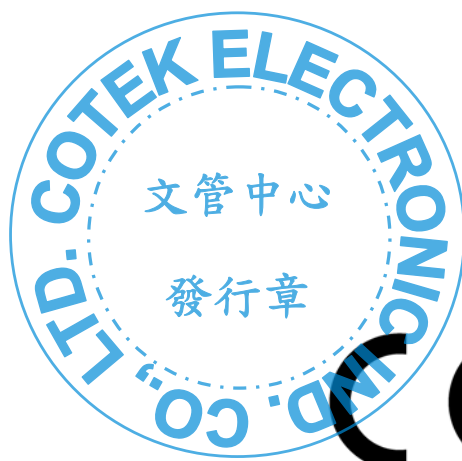

Contents

1. Important Safety Instructions	2
1-1 General safety precautions.....	2
1-2 Precautions when working with Batteries.....	2
2. Functional Characteristics	3
2-1 General Information.....	3
2-2 Application.....	4
2-3 Features.....	5
2-4 Electrical Performance.....	6
2-5 Mechanical drawings.....	10
3. Introduction	12
3-1 Front Panel Operation.....	12
3-2 Protections Features.....	16
3-3 DC Wiring Connections.....	16
3-4 Hard-wire Installation.....	20
3-5 Rear panel Operation.....	23
3-6 Installation.....	23
3-7 Inverter Operation.....	24
4 Information	25
4-1 Troubleshooting.....	25
4-2 Maintenance.....	25
4-3 Warranty.....	26
5. Appendices	27
5-1 FCC (Class A) Declaration of Conformity.....	27
5-2 e-mark (e13) Declaration of Conformity.....	29
5-3 EMC (Class A) Declaration of Conformity.....	36
5-4 CE (LVD EN60950) Declaration of Conformity.....	38



©Copyright: This manual is the copyright of COTEK Electronic Ind. Co., Ltd. And may not be reproduced or copied without the express permission of the owner.

1. Important Safety Instructions

**WARNING!**

Before using the Inverter, read and save the safety instructions.

1-1. General Safety Precautions

- 1-1-1. Do not expose the Inverter to rain, snow, spray, bilge or dust. To reduce risk of hazard, do not cover or obstruct the ventilation openings. Do not install the Inverter in a zero-clearance compartment. Overheating may result.
- 1-1-2. To avoid a risk of fire and electronic shock. Make sure that existing wiring is in good electrical condition; and that wire size is not undersized.
Do not operate the Inverter with damaged or substandard wiring.
- 1-1-3. This equipment contains components which can produce arcs or sparks. To prevent fire or explosion do not install in compartments containing batteries or flammable materials or in locations which require ignition protected equipment. This includes any space containing gasoline-powered machinery, fuel tanks, or joints, fittings, or other connection between components of the fuel system.

1-2. Precautions When Working with Batteries

- 1-2-1. If battery acid contacts skin or clothing, wash immediately with soap and water. If acid enters eye, immediately flood eye with running cold water for at least 20 minutes and get medical attention immediately.
- 1-2-2. Never smoke or allow a spark or flame in vicinity of battery or engine.
- 1-2-3. Do not drop a metal tool on the battery. The resulting spark or short-circuit on the battery or other electrical part may cause an explosion.
- 1-2-4. Remove personal metal items such as rings, bracelets, necklaces, and watches when working with a lead-acid battery.
A lead-acid battery produces a short-circuit current high enough to weld a ring or the like to metal, causing a severe burn.



2. Functional Characteristics

2-1. General Information



ST-series completes with stand –alone power inverter with AC transfer switch and is suitable for RV, Marin and Emergency appliances.

Either mode is front panel programmable.

In the first option, **Off-line mode**, AC output power will be supplied through the AC bypass mode in its normal operation. Upon AC input failure, output power will be diverted through the DC to AC Inverter Mode. Once AC mains are restored, the unit will revert from the Inverter Mode to the Bypass Mode.

In the second option, **On-line mode**, AC output power will be provided directly by the inverter from the DC source. Should the DC source or inverter fail, the system will transfer its output power through the bypass mode. Once the DC power source is restored, the system will revert to the inverter mode.

This power inverter series is a member of the most advanced line of mobile AC power systems available.

To get the most out of the power inverter, it must be installed and used properly. Please read the instructions in this manual before installation and operation this model.



WARNING!

The above two option are fixed during the production and customer unable to modify.



2-2. Application

- 2-2-1 Power tools—circular saws, drills, grinders, sanders, buffers, weed and hedge trimmers, air compressors.
- 2-2-2. Office equipment – computers, printers, monitors, facsimile machines, scanners.
- 2-2-3. Household items – vacuum cleaners, fans, fluorescent and incandescent lights, shavers, sewing machines.
- 2-2-4. Kitchen appliances – coffee makers, blenders, ice markers, toasters.
- 2-2-5 Industrial equipment – metal halide lamp, high – pressure sodium lamp.
- 2-2-6. Home entertainment electronics – television, VCRs, video games, stereos, musical instruments, satellite equipment.

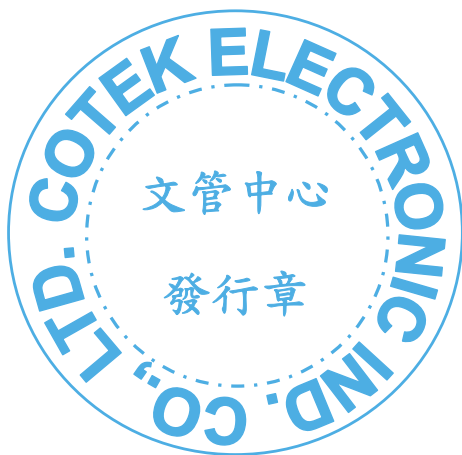

2-3. Features



- Pure sine wave output (THD < 3%) to operate higher-end electronic Equipments.
- Output frequency : 50 / 60Hz switch selectable
- Built in 16A/25A or 30A rating transfer switch.
- Speed up transfer time and synchronized operation with the AC source at all times that allows the transfer to be interruption-free for sensitive equipments.
- Built in advance microprocessor to make friendly interface with user.
- Low power “ Power Saving Mode “ to conserve energy
- Capable of driving highly reactive & capacitive loads at start moment.
- Hardwire AC connection model option.
- Loading controlled cooling fan.
- Smart remote controller.
- 3 LED indicators with tri-color display all operation status.
- High efficiency 88 ~ 94%.
- Protection:
 - Input over voltage and Input low voltage protection.
 - Low battery alarm
 - Over temperature protection.
 - Over load protection
 - Short Circuit protection
 - Reverse polarity protection.
 - AC circuit breaker (6Amp to 30Amp)



2-4. Electrical Performance

Specification	Model No.					
Item	ST1000-112	ST1000-124	ST1000-148	ST1000-212	ST1000-224	ST1000-248
Continuous Output Power	1000W					
Maximum Output Power (3Min.)	1150W					
Surge Rating	2000W					
Input Voltage	12V	24V	48V	12V	24V	48V
Output Voltage	100 / 110 / 120V ± 5%			220 / 230 / 240V ± 3%		
Frequency (Switch Selectable)	50 / 60Hz					
Output Waveform	Pure Sine Wave (THD < 3%)					
Efficiency (full load)	88%	90%	92%	90%	93%	94%
No Load Current Draw	1.43A	0.75A	0.38A	1.25A	0.65A	0.35A
Stand-By Current Draw	0.25A	0.15A	0.09A	0.25A	0.15A	0.09A
Input Voltage Regulation	10.5-15 VDC	21.0-30 VDC	42.0-60 VDC	10.5-15 VDC	21.0-30 VDC	42.0-60 VDC
Input Level Indicator	Red / Orange / Green LED					
Load Level Indicator						
Failure Indicator	Red LED					
Protection	Overload, Short Circuit, Reverse Polarity (Fuse), Over Temperature Over/Under Input Voltage, AC Input Circuit Breaker					
Circuit Breaker	30 Amp			6 Amp		
Remote Control Unit	CR6 / CR8 Optional					
Synchronous AC transfer	YES					
Transfer switch	30 Amp			16 Amp		
Transfer Time	Inverter to utility AC : 8 ~ 10msec. ; Utility AC to inverter : 16 ~ 50 msec					
Safety	Meet UL458			-----		
EMC	EMI Conduction&Radiation	Compliance to FCC Class A			Compliance to EN55022 classA	
	EMS Immunity	-----			Compliance to EN61000-3-2,3	
	LVD	-----			Compliance to EN60950-1	
	e-MARK	-----			Compliance to e-13*72/245/ECC,95/54 EC	
Operating Temperature Range	0 - 40 ~					
Storage Temperature Range	-30 ~ to 70 ~					
Cooling	Loading controlled cooling fan					
Dimensions	373(L)*236(W)*115(H) mm / 14.7(L)*9.29(W)*4.53(H) Inch					
Weight	6.2 kg / 13.6 Lbs.					

Note: The specifications are subject to change without notice.

2-4. Electrical Performance

Specification		Model No.					
Item	ST1500-112	ST1500-124	ST1500-148	ST1500-212	ST1500-224	ST1500-248	
Continuous Output Power	1500W						
Maximum Output Power (3Min.)	1725W						
Surge Rating	3000W						
Input Voltage	12V	24V	48V	12V	24V	48V	
Output Voltage	100 / 110 / 120V ± 5%			220 / 230 / 240V ± 3%			
Frequency (Switch Selectable)	50 / 60Hz						
Output Waveform	Pure Sine Wave (THD < 3%)						
Efficiency (full load)	88%	91%	92%	92%	93%	94%	
No Load Current Draw	1.45A	0.75A	0.40A	1.40A	0.70A	0.40A	
Stand-By Current Draw	0.28A	0.15A	0.09A	0.28A	0.15A	0.09A	
Input Voltage Regulation	10.5-15 VDC	21.0-30 VDC	42.0-60 VDC	10.5-15 VDC	21.0-30 VDC	42.0-60 VDC	
Input Level Indicator	Red / Orange / Green LED						
Load Level Indicator							
Failure Indicator	Red LED						
Protection	Overload, Short Circuit, Reverse Polarity (Fuse), Over Temperature Over/Under Input Voltage, AC Input Circuit Breaker						
Circuit Breaker	30 Amp			10 Amp			
Remote Control Unit	CR6 / CR8 Optional						
Synchronous AC transfer	YES						
Transfer switch	30 Amp			10Amp			
Transfer Time	Inverter to utility AC : 8 ~ 10msec. ; Utility AC to inverter : 16 ~ 50 msec						
Safety	Meet UL458			-----			
EMC	EMI Conduction&Radiation	Compliance to FCC Class A			Compliance to EN55022 classA		
	EMS Immunity	-----			Compliance to EN61000-3-2,3		
	LVD	-----			Compliance to EN60950-1		
	e-MARK	-----			Compliance to e-13*72/245/ECC,95/54 EC		
Operating Temperature Range	0 - 40 ~						
Storage Temperature Range	-30 ~ to 70 ~						
Cooling	Loading controlled cooling fan						
Dimensions	403(L)*236(W)*115(H) mm / 15.9(L)*9.29(W)*4.53(H) Inch						
Weight	7.0 kg / 15.4 Lbs.						

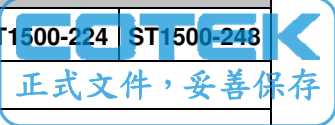

Note: The specifications are subject to change without notice.

2-4. Electrical Performance

Specification	Model No.					
Item	ST2000-112	ST2000-124	ST2000-148	ST2000-212	ST2000-224	ST2000-248
Continuous Output Power	2000W					
Maximum Output Power (3Min.)	2300W					
Surge Rating	4000W					
Input Voltage	12V	24V	48V	12V	24V	48V
Output Voltage	100 / 110 / 120V ± 5%			220 / 230 / 240V ± 3%		
Frequency (Switch Selectable)	50 / 60Hz					
Output Waveform	Pure Sine Wave (THD < 3%)					
Efficiency (full load)	88%	91%	92%	90%	93%	94%
No Load Current Draw	2.6A	1.50A	0.70A	2.3A	1.1A	0.65A
Stand-By Current Draw	0.60A	0.30A	0.2A	0.60A	0.3A	0.15A
Input Voltage Regulation	10.5-15 VDC	21.0-30 VDC	42.0-60 VDC	10.5-15 VDC	21.0-30 VDC	42.0-60 VDC
Input Level Indicator	Red / Orange / Green LED					
Load Level Indicator						
Failure Indicator	Red LED					
Protection	Overload, Short Circuit, Reverse Polarity (Fuse), Over Temperature Over/Under Input Voltage, AC Input Circuit Breaker					
Circuit Breaker	30Amp					
Remote Control Unit	CR6 / CR8 Optional					
Synchronous AC transfer	YES					
Transfer switch	30Amp			25 Amp		
Transfer Time	Inverter to utility AC : 8 ~ 10msec. ; Utility AC to inverter : 16 ~ 50 msec					
Safety	Meet UL458			-----		
EMC	EMI Conduction&Radiation	Compliance to FCC Class A			Compliance to EN55022 classA	
	FMS Immunity	-----			Compliance to EN61000-3-2,3	
	LVD	-----			Compliance to EN60950-1	
	e-MARK	-----			Compliance to e-13*72/245/ECC,95/54 EC	
Operating Temperature Range	0 - 40 ~					
Storage Temperature Range	-30 ~ to 70 ~					
Cooling	Loading controlled cooling fan					
Dimensions	433(L)*332(W)*115(H) mm / 17(L)*13(W)*4.53(H) Inch					
Weight	11.2 kg / 24.6 Lbs.					

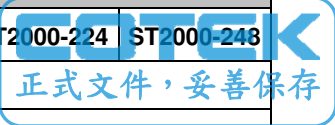

Note: The specifications are subject to change without notice.

2-4. Electrical Performance

Specification	Model No.					
Item	ST2500-112	ST2500-124	ST2500-148	ST2500-212	ST2500-224	ST2500-248
Continuous Output Power	2500W					
Maximum Output Power (3Min.)	2875W					
Surge Rating	5000W					
Input Voltage	12V	24V	48V	12V	24V	48V
Output Voltage	100 / 110 / 120V ± 5%			220 / 230 / 240V ± 3%		
Frequency (Switch Selectable)	50 / 60Hz					
Output Waveform	Pure Sine Wave (THD < 3%)					
Efficiency (full load)	88%	91%	92%	90%	93%	94%
No Load Current Draw	2.62A	1.53A	0.72A	2.32A	1.15A	0.68A
Stand-By Current Draw	0.60A	0.30A	0.2A	0.60A	0.3A	0.15A
Input Voltage Regulation	10.5-15 VDC	21.0-30 VDC	42.0-60 VDC	10.5-15 VDC	21.0-30 VDC	42.0-60 VDC
Input Level Indicator	Red / Orange / Green LED					
Load Level Indicator						
Failure Indicator	Red LED					
Protection	Overload, Short Circuit, Reverse Polarity (Fuse), Over Temperature Over/Under Input Voltage, AC Input Circuit Breaker					
Circuit Breaker	30 Amp					
Remote Control Unit	CR6 / CR8 Optional					
Synchronous AC transfer	YES					
Transfer switch	30Amp			25 Amp		
Transfer Time	Inverter to utility AC : 8 ~ 10msec. ; Utility AC to inverter : 16 ~ 50 msec					
Safety	Meet UL458			-----		
EMC	EMI Conduction&Radiation	Compliance to FCC Class A			Compliance to EN55022 classA	
	EMS Immunity	-----			Compliance to EN61000-3-2,3	
	LVD	-----			Compliance to EN60950-1	
	e-MARK	-----			Compliance to e-13*72/245/ECC,95/54 EC	
Operating Temperature Range	0 - 40 ~					
Storage Temperature Range	-30 ~ to 70 ~					
Cooling	Loading controlled cooling fan					
Dimensions	463(L)*332(W)*115(H) mm / 18.2(L)*13(W)*4.53(H) Inch					
Weight	12 kg / 26.4 Lbs.					

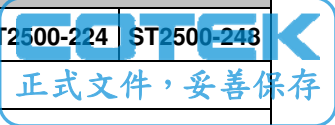

Note: The specifications are subject to change without notice.

2-5. Mechanical drawings

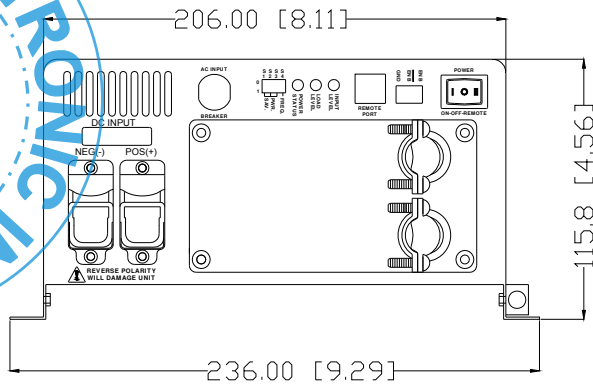
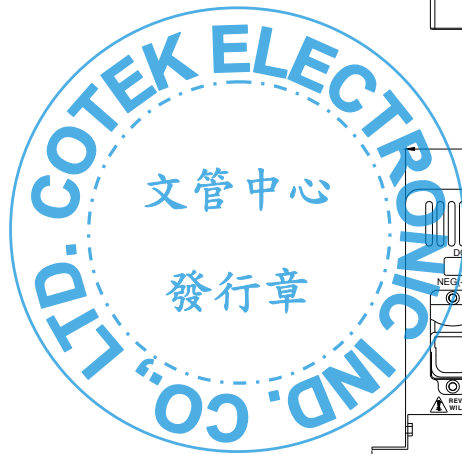
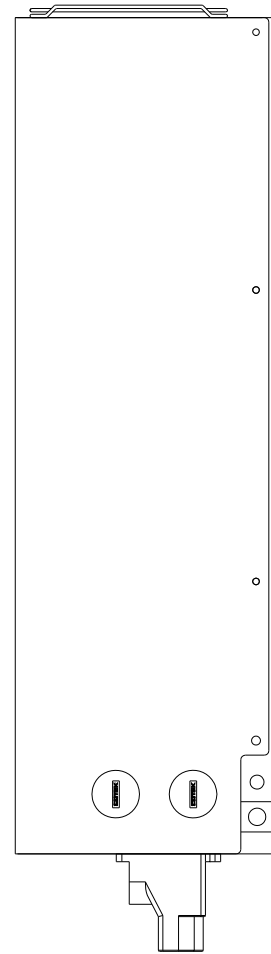
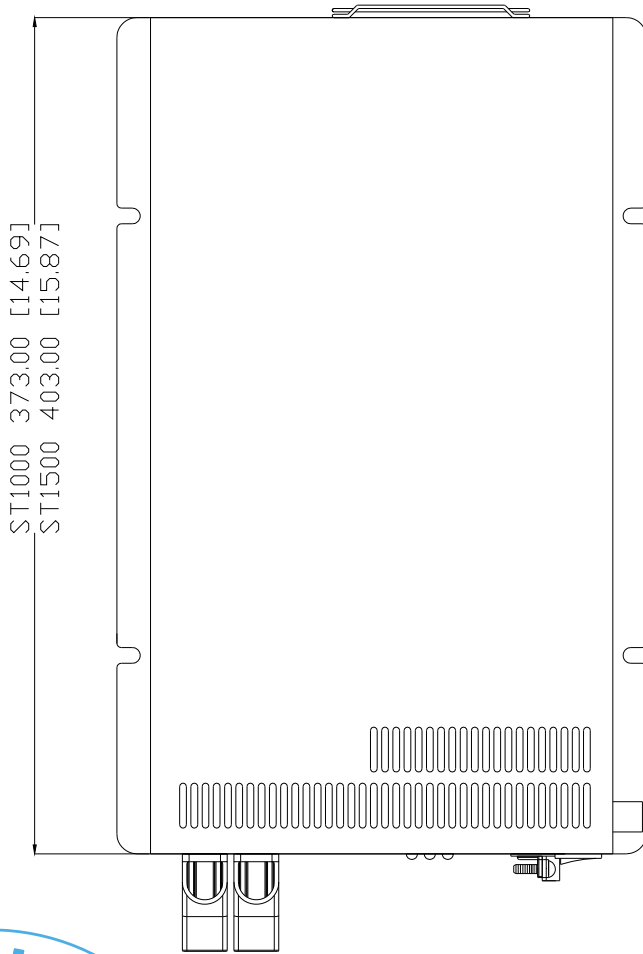
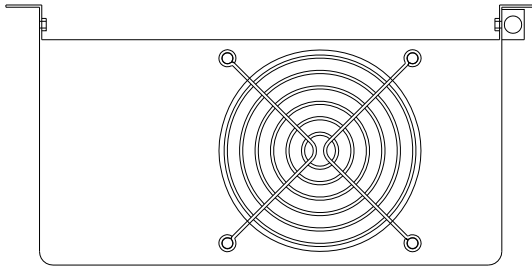

2-5. Mechanical drawings

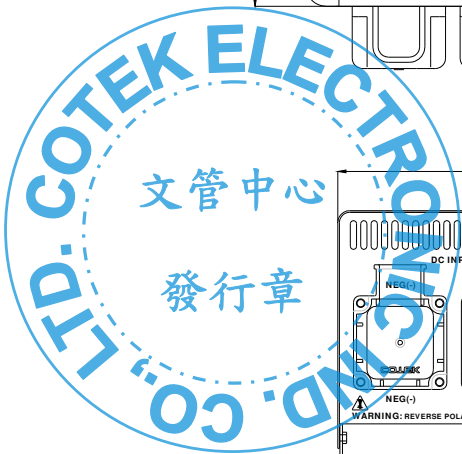
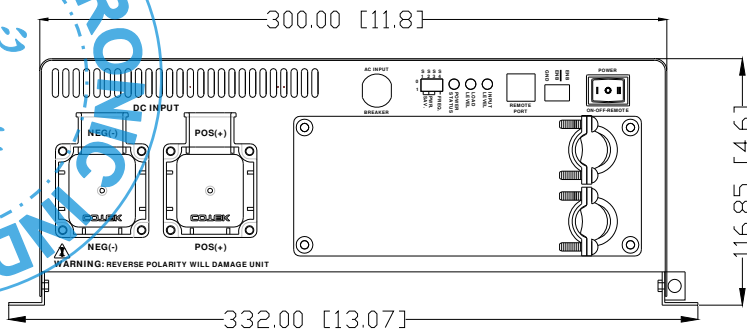
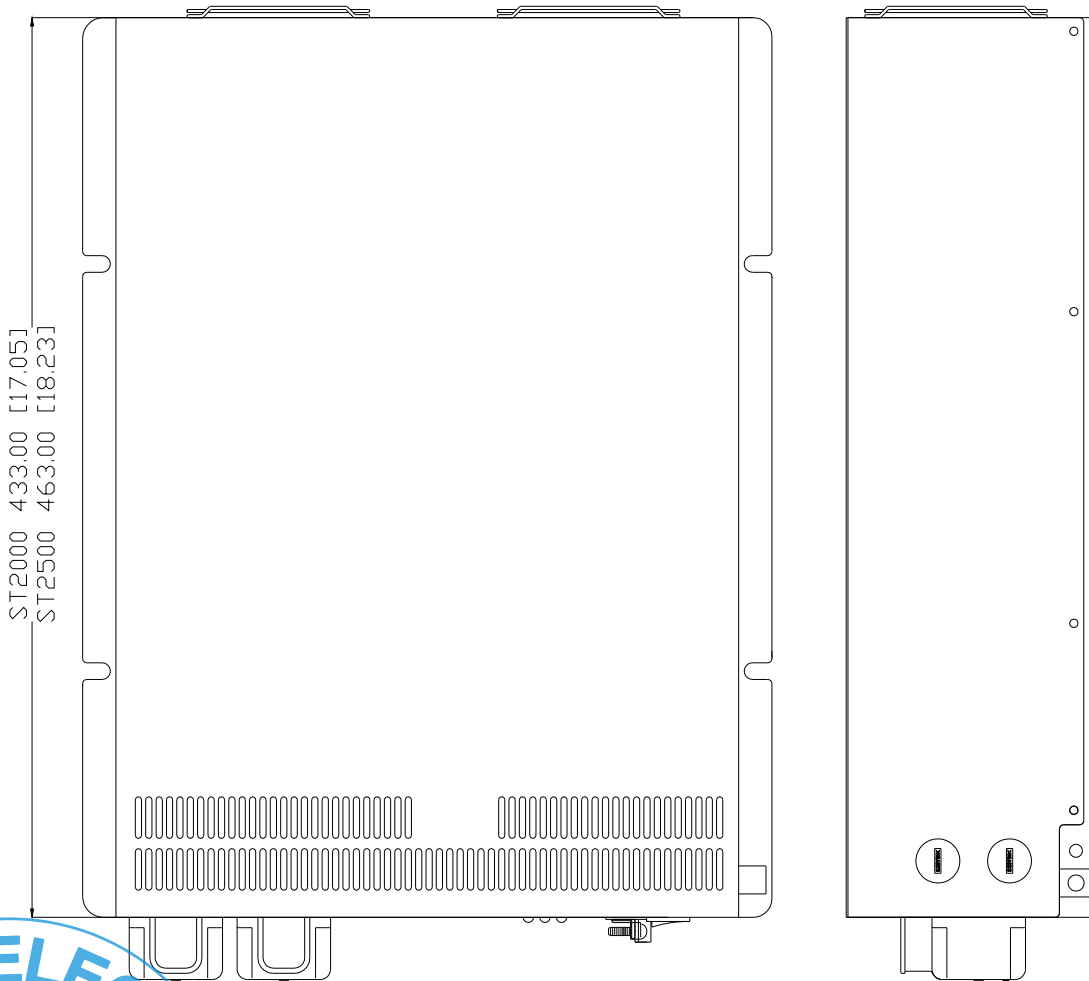
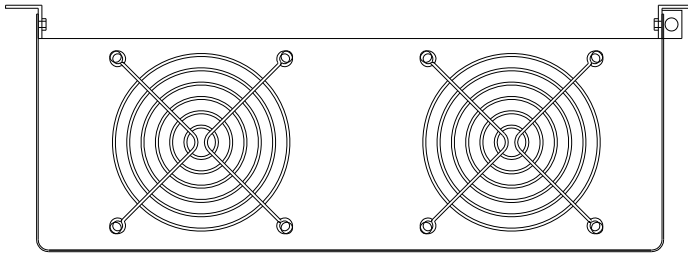

3. Introduction

3-1. Front Panel Operation



Front view

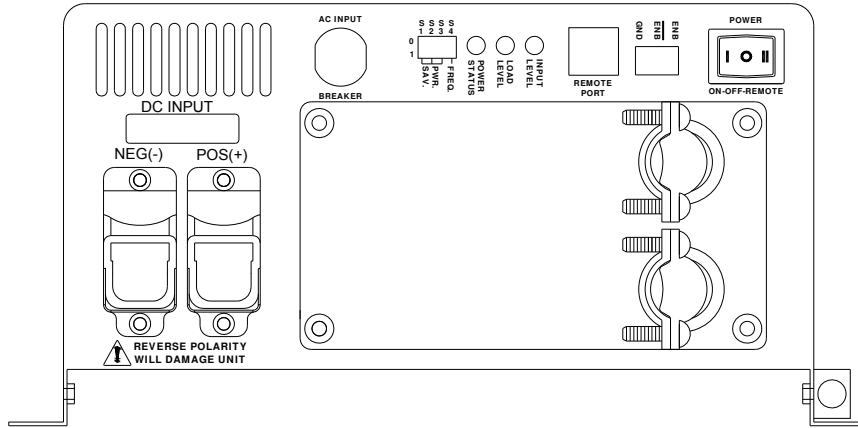

ST-1000/ST-1500

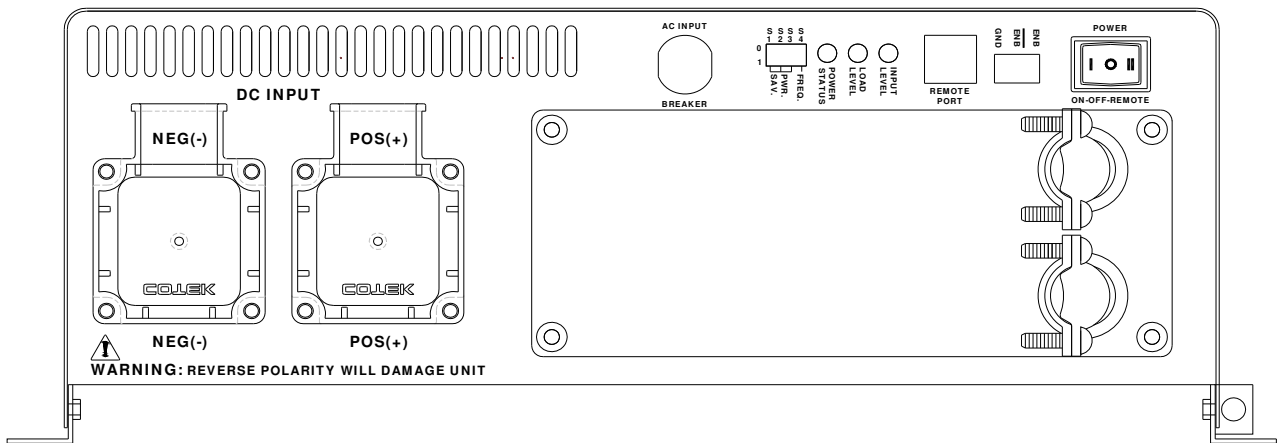

ST-2000/ST-2500

3-1-1. Power ON / OFF / REMOTE (Main) switch:

- a. Before installing the inverter, you need to ensure the main switch is in the OFF position.
- b. Before using the remote unit, you need to ensure the main switch is in the REMOTE position.

3-1-2. AC input Circuit Breaker:

The AC input circuit breaker protects the model from overload. When an overload condition exists, the circuit breaker stops to supply output AC grid power. To reset it, push the circuit breaker switch then the model will be back in normal operation. The source fault should be corrected before you reset it.

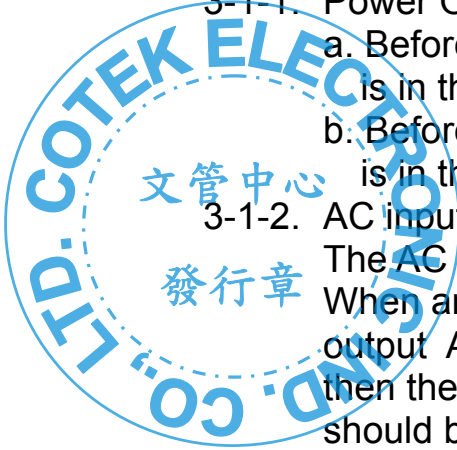

3-1-3 Green terminal

- 1) Before installing the inverter, you need to ensure the main switch must be "OFF".
- 2) Before using the remote control terminal, you need to ensure the main switch must be "REMOTE".
- 3) Ensure the remote contacts off.
- 4) Use 20 ~ 24 #AWG wire to connect the remote control terminal.
- 5) Remote control ON/OFF inverter setup status:

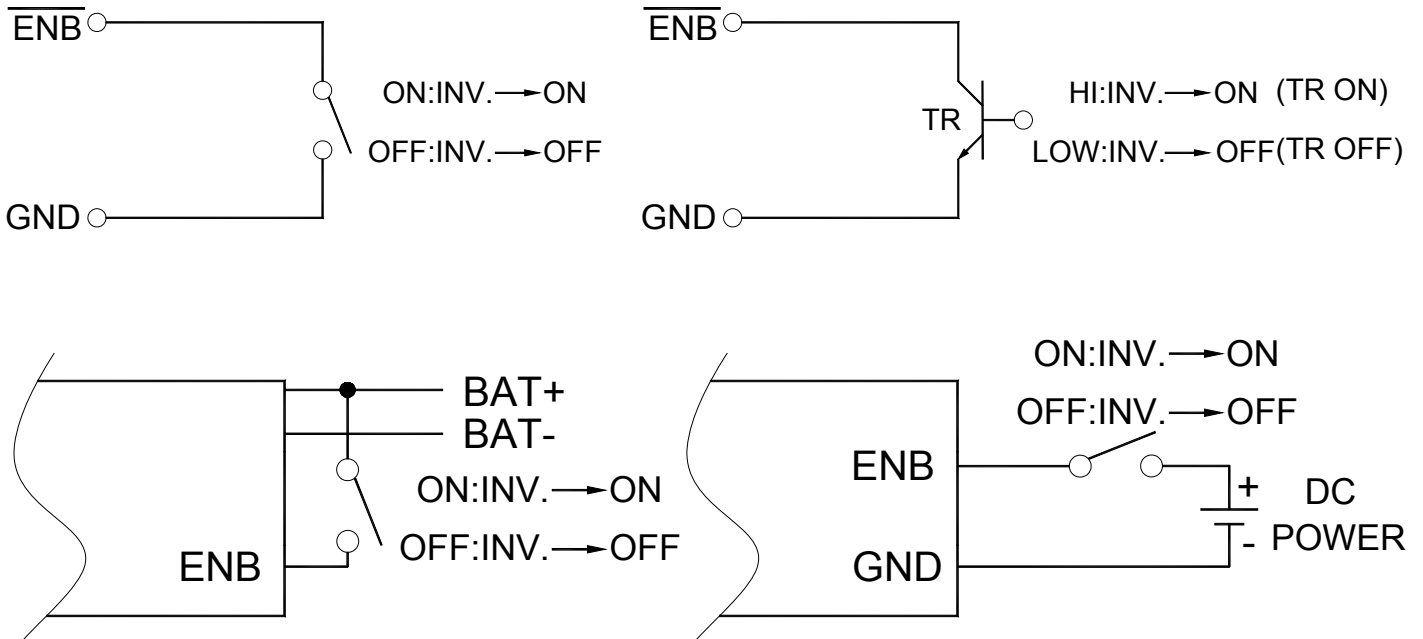

NOTE: At the same time, only can use one model to control the inverter.
The maximum level is the same as input DC voltage.

3-1-4. Remote Port:

The ST Series Inverter is compatible with any of these remote controllers: CR-6 or CR-8.

3-1-5. Input Level : Display Input Voltages

LED Status	DC 12V	DC 24V	DC 48V
RED Blink (slow)	10.3~10.6	20.5~21.2	40.8~42.4
RED	10.6~11.0	21.2~21.8	42.4~43.5
ORANGE	11.0~12.1	21.8~24.1	43.5~48.1
GREEN	12.1~14.2	24.1~28.6	48.1~56.3
ORANGE Blink	14.2~15.0	28.6~30.0	56.3~59.6
OVER RED BLINK	15.0↑	30.0↑	59.6↑

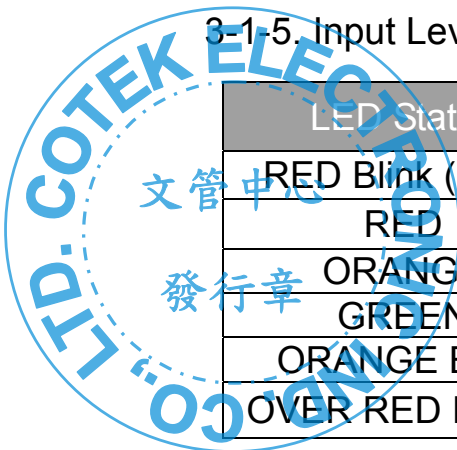

3-1-6. Load Level : Display AC Loads (Watts)



LED Status	DARK	GREEN	ORANGE	RED	Over 960W
ST1000	0 ~ 80W	80 ~ 330W	330 ~ 750W	750 ~ 960W	Over 960W
ST1500	0 ~ 120W	120 ~ 495W	495 ~ 1125W	1125 ~ 1450W	Over 1450W
ST2000	0 ~ 160W	160 ~ 660W	660 ~ 1500W	1500 ~ 1920W	Over 1920W
ST2500	0 ~ 200W	200 ~ 825W	825 ~ 1875W	1875 ~ 2390W	Over 2390W

3-1-7. Power Status : Display Power & Fault Status

Orange LED	LED Signal	Status
Solid	—————	Power OK
Slow Blink	- - - -	Power Saving
Red LED	LED Signal	Status
Fast Blink	- - - - - - - -	OVP
Slow Blink	- - - -	UVP
Intermittent Blink	OTP
Solid	—————	OLP
Green LED	LED Signal	Status
Solid	—————	AC GRID INPUT OK

3-1-8. AC Frequency : Selected by “S4” Dip Switch

Frequency	S4
50 HZ	OFF
60 HZ	ON

3-1-9. Power Saving Mode: Power Saving Mode is adjustable and set by the Dip Switches, S1, S2 and S3 on the front panel.

Example: The load should be set above 15W. If the load is below 15W, the power saving mode will be activated.

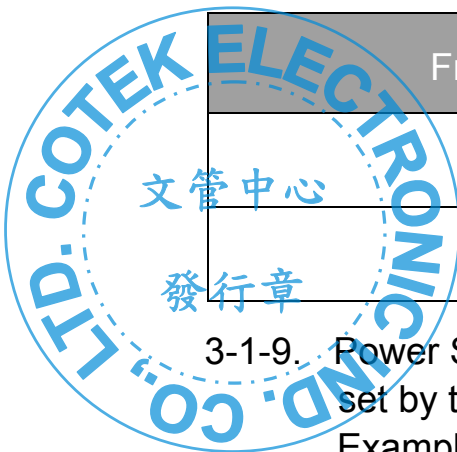



ST1000 ST1500	ST2000 ST2500	S1	S2	S3
DISABLE	DISABLE	OFF	OFF	OFF
20W	40W	ON	OFF	OFF
40W	80W	OFF	ON	OFF
55W	125W	ON	ON	OFF
75W	170W	OFF	OFF	ON
95W	210W	ON	OFF	ON
115W	245W	OFF	ON	ON
135W	280W	ON	ON	ON

3-1-10. DC Input Terminals:

Connect DC input terminals to 12V / 24V / 48V battery or other power sources.

[+] represents positive, [-] represents negative. Reverse polarity connection can blow the internal fuse and may damage the inverter permanently.

Model	DC Input Voltage	
	Minimum	Maximum
12V	10.5V	15.0V
24V	21.0V	30.0V
48V	42.0V	60.0V

3-1-11. Chassis Ground: Connect the wire # 8 AWG to vehicle chassis.



WARNING!
Operating the inverter without a proper ground connection may cause electrical safety hazard.



3-2. Protections Features

Model	DC Input (VDC)					Over Temperature Protection			
	Over Voltage		Under Voltage Alarm	Under Voltage		INTERIOR		HEAT SINK	
	Shut-down	Restart		Shut-down	Restart	Shut-down	Restart	Shut-down	Restart
12V	15.3	14.3	11.0	10.2	12.7	70°C	45°C	90°C	60°C
24V	30.6	28.6	22.0	20.3	25.2				
48V	61.2	57.2	44.0	40.8	49.7				

3-3 DC Wiring Connections

Follow the instructions to connect the battery cables to DC input terminals of the Inverter. The cable should be as short as possible (less than 6 feet / 1.8 meters ideally) so that it can handle the required current in accordance with the electrical codes or regulations application. Inappropriate length of cables will deteriorate the inverter performance such as poor surge capability, frequent low-input voltage warnings, and shutdown. UVP warning occurs when DC voltage drops across the cables from the inverter to the batteries. The longer or narrower the cables, the more the voltage drop.

Increasing your DC cable size will help improve the situation.

The following recommended cables are for the best performance of the inverter. (Apply both 120V and 230V versions)

Model No	Wire AWG	Inline Fuse
ST1000-112 / 212	# 2	150 A
ST1000-124 / 224	# 4	80 A
ST1000-148 / 248	# 6	40 A
ST1500-112 / 212	# 2	200 A
ST1500-124 / 224	# 4	100 A
ST1500-148 / 248	# 6	50 A
ST2000-112 / 212	# 2/0	250 A
ST2000-124 / 224	# 1/0	125 A
ST2000-148 / 248	# 2	70A
ST2500-112 / 212	# 4/0	400 A
ST2500-124 / 224	# 2/0	200 A
ST2500-148 / 248	# 1/0	100 A

3-3-1. Connect the cables to the power input terminals on the front panel of the inverter. The red terminal is positive (+) and black terminal is negative (-). Insert the cables into the terminals and tighten screw to clamp the wires securely.



WARNING!

Make sure all the DC connections are tight (torque to 9 – 10 ft-lbs, 11.7 – 13 Nm). Loose connections could result overheat in a potential hazard.



WARNING!

The installation of a fuse must be on positive cable. Failure to place a fuse on “+” cables running between the inverter and battery may cause damage to the inverter and will void warranty.

Also, only use high quality copper wire and keep the cable length short which is a maximum of 3 - 6 feet.

Battery to inverter cable connection

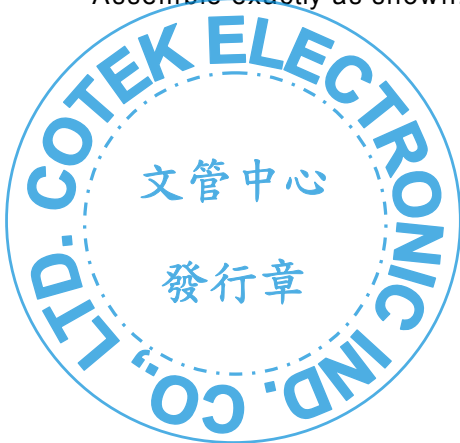
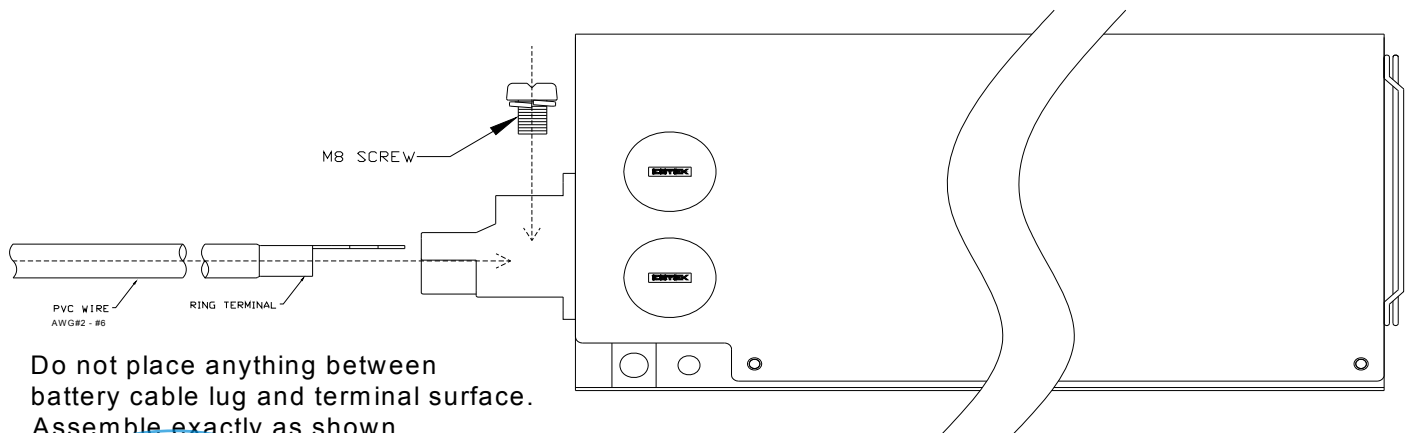

ST-1000
ST-1500

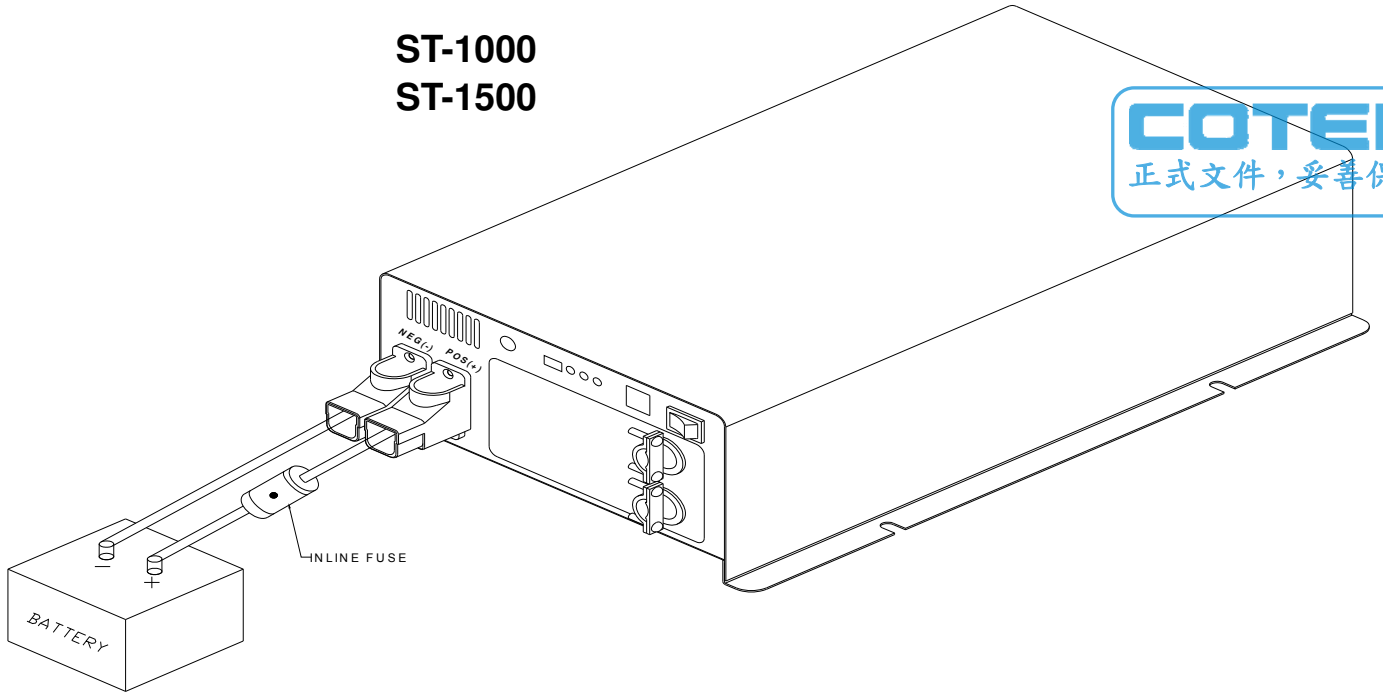
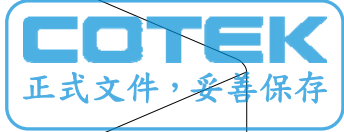

Battery to inverter cable connection

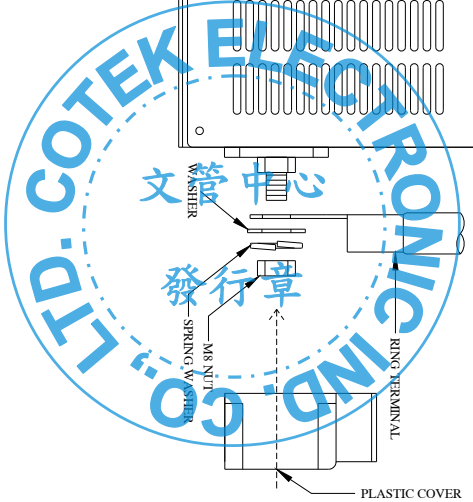
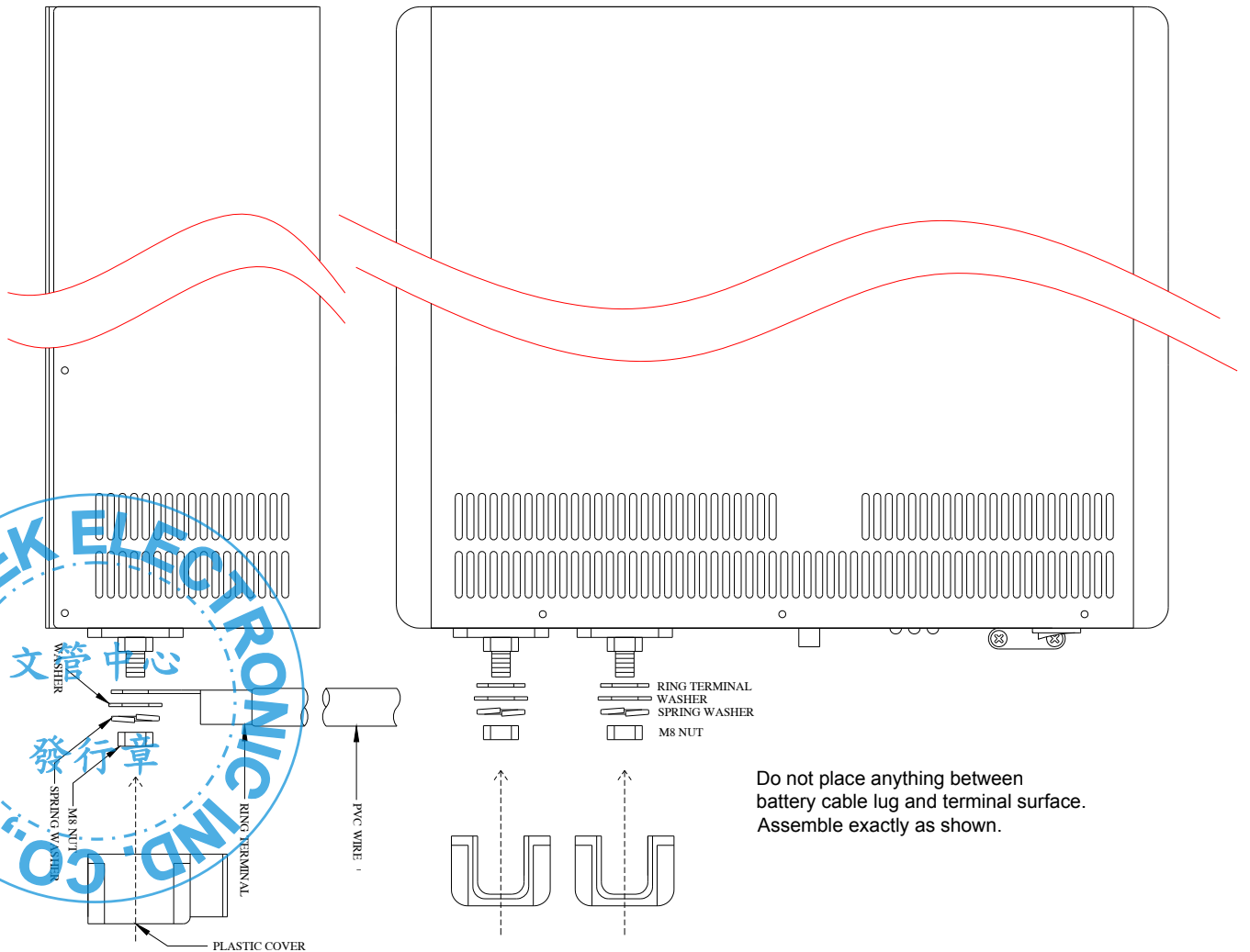

ST2000
ST2500

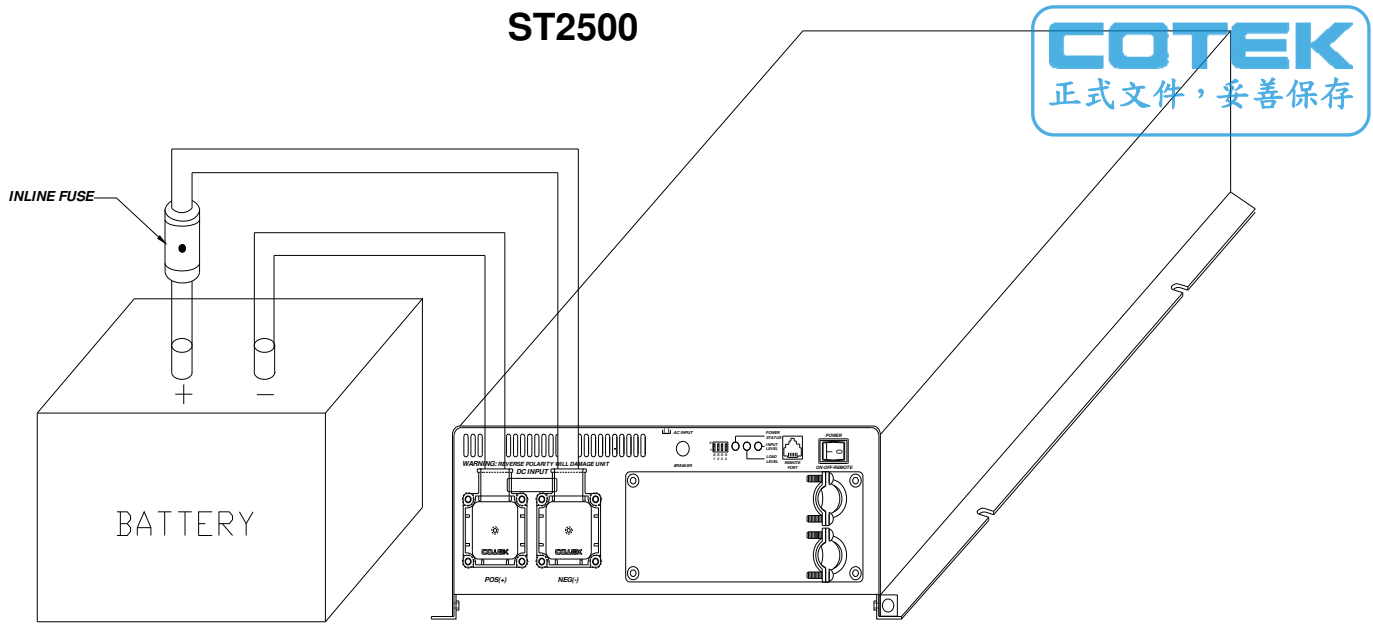

3-4 Hard-wire Installation

AC wiring connections:

3-4-1. The AC wiring compartment is located on the front panel of the ST series. Remove the AC wiring compartment cover to gain access to the AC terminal.



WARNING!



Before you connect AC wiring to the terminals of compartment cover, ensure to check the label in the compartment for correct connections. Wrong connection will damage the inverter.

CAUTION !

It is advised that all the electrical installation should conform to the local electrical codes and should be carried out by a certified electrician.

When the unit is feeding the internally inverted voltage (Power Status LED is green, power from the AC input source is not available), the current carrying conductors connected to the “L” and “N” terminals of the AC output will be isolated from the metal chassis of the inverter. Hence, during this condition, when the metal chassis of the inverter is connected to the earth ground, the “N” terminal of the AC output will not be grounded (bonded) to the earth ground. Under this condition, the “N” terminal of the AC output will not be a Neutral in the true sense. Do not touch this terminal as it will be at an elevated voltage(almost half the value the AC output voltage) with respect to the metal chassis / earth ground and may produce an electrical shock when touched!

When the unit is transferring power from the AC input source (Power Source LED is orange), the grounding condition of the “N” terminal of the AC output will be the same as the condition of the “N” terminal of the AC input source. If the AC input source is the power supplied from the utility, the “N” terminal would be a Neutral in the true sense, will normally be bonded to the earth ground and will read almost 0 V with respect to the earth ground. In this case, touching this terminal will not be a shock hazard.

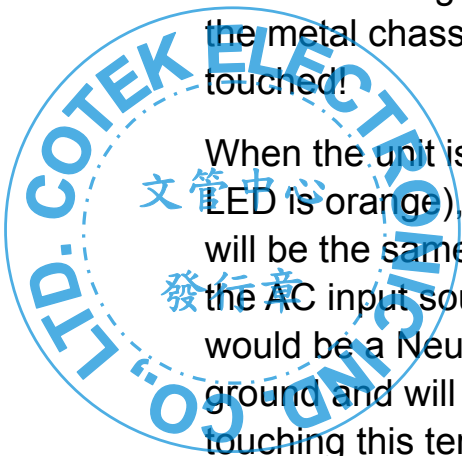

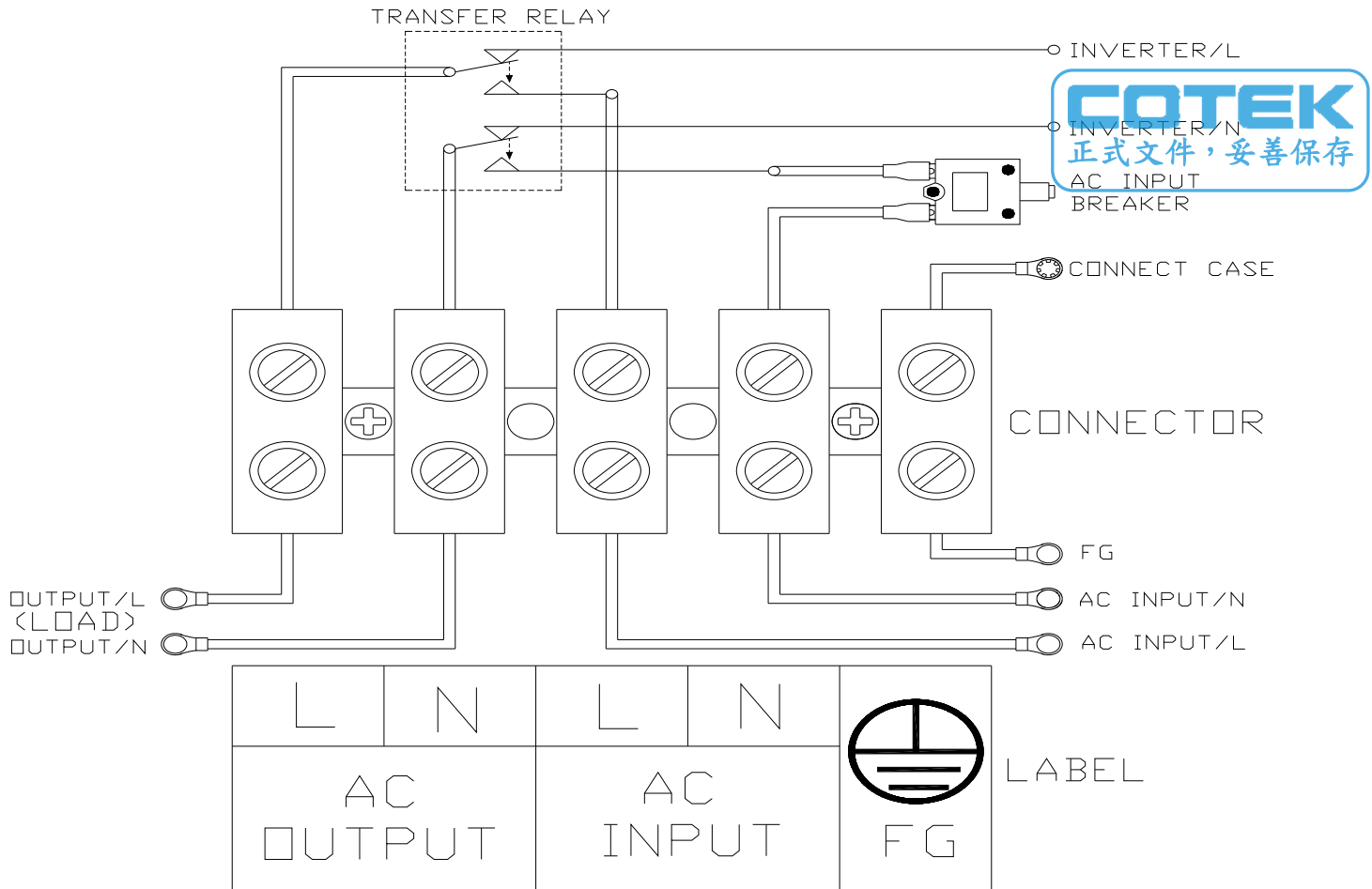

3-4-2. Connect AC output and AC input wiring to the ST series terminals. Please take the following information as your reference.

Terminal		Wire color	Wire length / gauge	
			ST1000&ST1500	ST2000&ST2500
AC OUTPUT	Line (L)	Black	Within 16 feet / AWG# 14~16	Within 16 feet / AWG# 10~12
	Neutral (N)	White		
AC INPUT	Line (L)	Brown		
	Neutral (N)	Blue		
Ground		Green / Yellow or Bare copper	26~32 feet / AWG# 12~14	26~32 feet / AWG# 8~10

3-4-3. Please double check and review all connections to ensure the wires are in correct terminals and the connections are tight.

3-4-4. Before connecting AC output and AC input terminals of the ST series, you can either use front compartment cover or a side hole to coil out. Both AC input and AC output are coiled out from the front compartment cover when in production. If you want to change the position, you should open the top cover first, and then switch the wire of the front compartment cover and the plastic cover of the side of top cover.



WARNING !

If the connection distribution of the front panel is not feasible for your appliances, ST series also provides another distribution on the side panel, to utilize it please be ensured to remove the plastic covers before installing the strain relief; moreover, replace the empty hole of front panel with removed plastic covers for safety purpose.

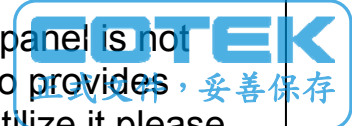

ST1000

ST1500

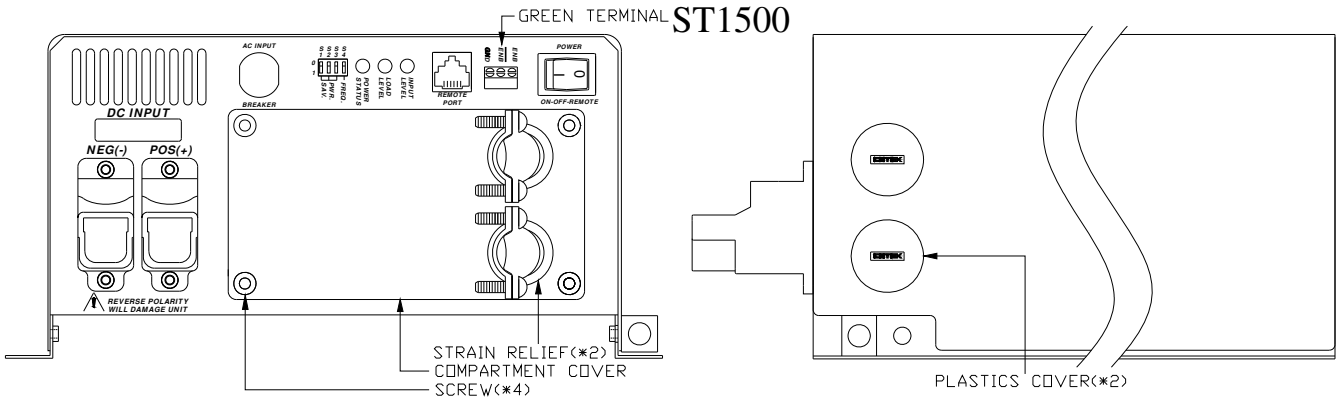

ST2000

ST2500

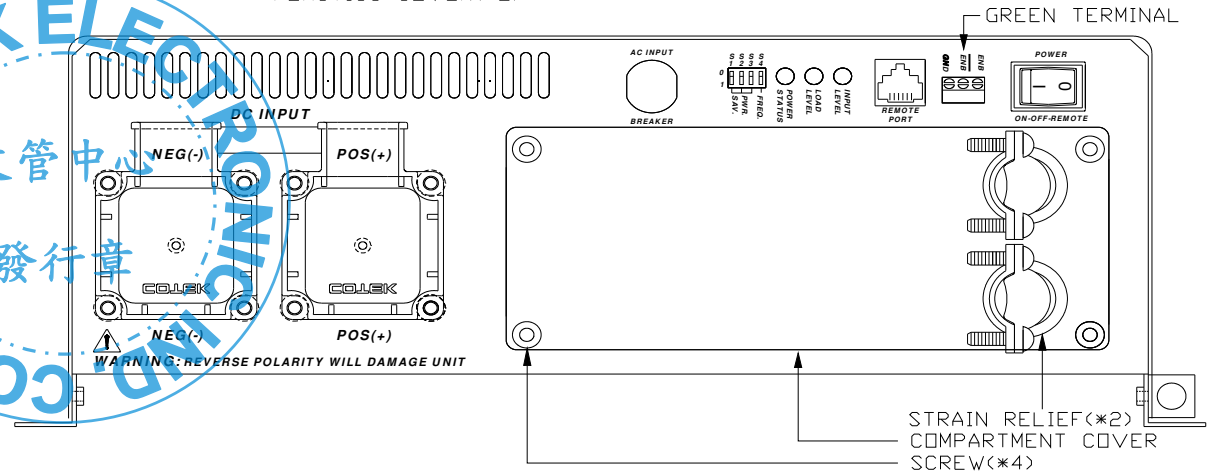
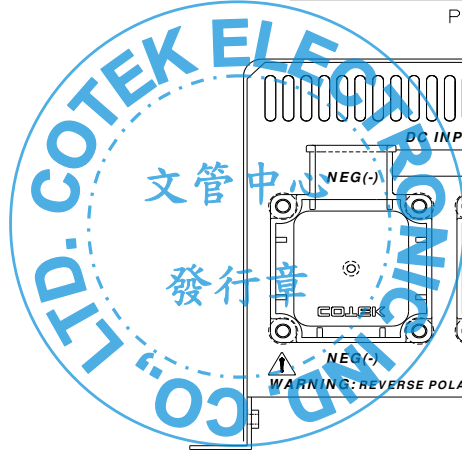
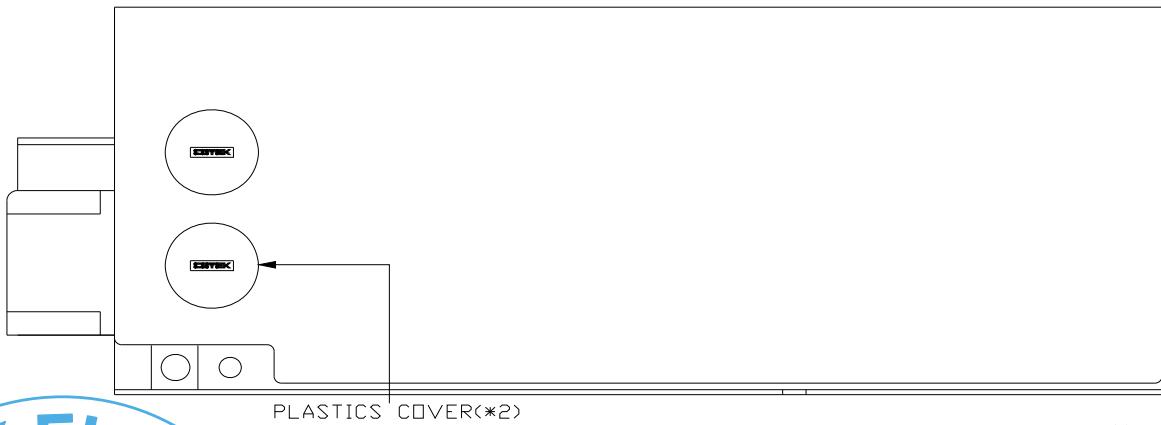

3-5. Rear Panel Operation

Rear view

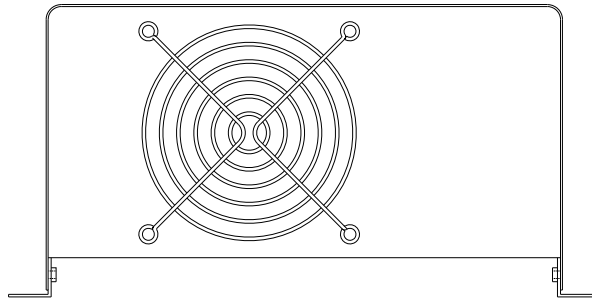

ST-1000/ST-1500

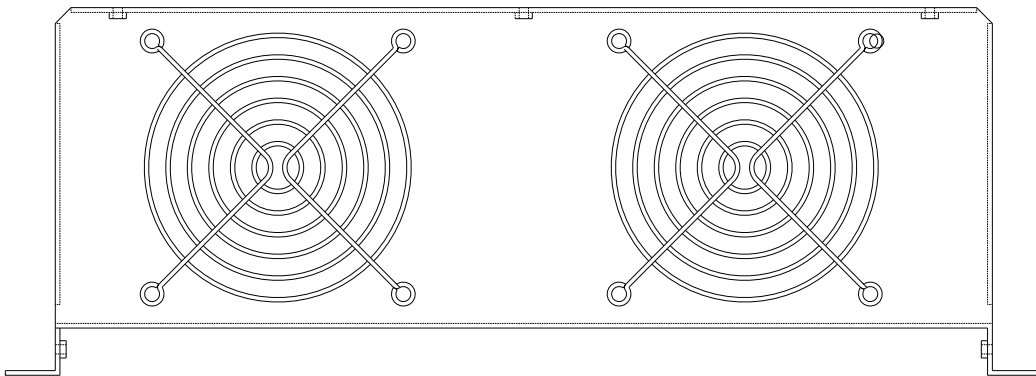

ST-2000/ST-2500

3-5-1. Fan Ventilation:

Be sure to keep it a distance (at least 1 inch) from surrounding things.

3-6. Installation

The power inverter should be installed in a location that meets the following requirements:

3-6-1. Dry – Do not allow water to drip or splash on the inverter.

3-6-2. Cool – Ambient air temperature should be between 0°C and 40°C, the cooler the better.

3-6-3. Safety – Do not install batteries in compartment or other areas where flammable fumes existence such as fuel storage areas or engine compartments.

3-6-4. Ventilated – Allow at least one inch of clearance around the inverter for air flow. Ensure the ventilation shafts on the rear and bottom of the unit are not obstructed.

- 3-6-5. Dust-free – Do not install the Inverter in a dusty environments where dust, wood particles or other filings/shavings are present. The dust can be pulled into the unit when the cooling fan is operation.
- 3-6-6. Close to batteries – Avoid excessive cable lengths but do not install the inverter in the same compartment as batteries. Use the recommended wire lengths and sizes (see section 4-3). Do not mount the inverter at the place where it is exposed to the gases produced by the battery. These gases are very corrosive and prolonged exposure will damage the inverter.



WARNING!

Shock Hazard. Before proceeding further, carefully check that the inverter is NOT connected to any batteries, and that all wiring is disconnected from any electrical sources . Do not connect the output terminals of the inverter to an incoming AC source.

3-7. Inverter Operation

Switch the power ON, then the power inverter is ready to supply AC power to the loads. Turn on the loads separately after the inverter is ON to prevent OVP status caused by the surge power.

- 3-7-1. Switch the power ON, then the buzzer will send out beep sound. At the moment, the inverter is doing self-diagnosis. Then the LED's indicators will also show various colors.

Finally, the buzzer will send out another beep, and the Input Level and Status LED indicators will turn green. Then the inverter will start to work.

- 3-7-2. Switch the power OFF, then the inverter stops and all the lights that are On will go Off.

- 3-7-3. Switch the power inverter and the test load ON, then the inverter will supply the power to the load. If you want to measure true RMS voltage output of the inverter, a meter such as FLUKE 45 BECKMAN 4410 or TRIPLETT 4200 must be used.

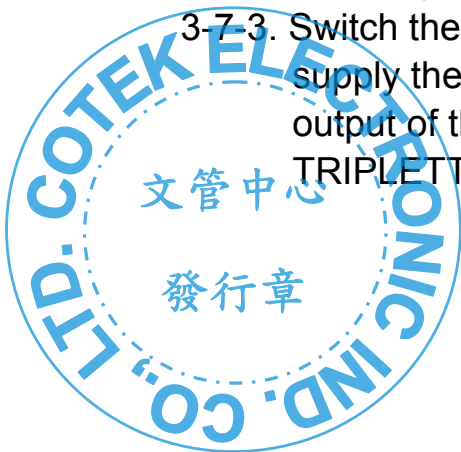

4. Information

4-1. Troubleshooting



WARNING

Do not open or disassemble the ST series Inverter. Attempting to service the unit may cause the risk of electrical shock or fire.

Problems and Symptoms

Possible Cause

Solutions

No AC Power "Output"

STATUS illuminates the LED

a. Power status light is blinking fast.	Over input voltage. (OVP)	Check input voltage Reduce input voltage.
b. Power status light is Blinking slowly.	Low input voltage. (UVP)	Recharge battery. Check connections and cables.
c. Power status light is blinking Intermittently.	Thermal shutdown. (OTP)	Improve ventilation. Make sure ventilation, shafts of the inverter are not obstructed. Lower ambient temperature.
d. Power status light is glowed steadily.	Short circuit. Wiring error. Over Loading (OLP)	Check AC wiring for short circuit. Reduce load.

4-2. Maintenance

Very little maintenance is required to keep your inverter operating properly. You should clean the exterior of the unit periodically with a damp cloth to prevent accumulation of dust and dirt. At the same time, tighten the screws on the DC input terminals.



4-3. Warranty



We guarantee this product against defects in materials and workmanship for a period of 24 months from the date of purchase and will repair or replace any defective power inverters if you directly returned them to us with postage paid.

Please note that we are only responsible for ensuring our products are operational before delivering. This warranty will be considered void if the unit has been misused, altered, or accidentally damaged. Cotek is not liable for anything that occurs as a result of the user's fault.



5. Appendices



CERTIFICATE

Issued Date: Dec. 28, 2004
Report No.: 051H001F

This is to certify that the following designated product

Product	: POWER INVERTER
Trade name	: COTEK
Model Number	: ST1500-112, ST1500-124, ST1500-148
Company Name	: COTEK ELECTRONIC IND. CO., LTD.

This product, which has been issued the test report listed as above in Quietek Laboratory, is based on a single evaluation of one sample and confirmed to comply with the requirements of the following EMC standard.

FCC CFR Title 47 Part 15 Subpart B: 2003, CISPR 22:1997

TEST LABORATORY

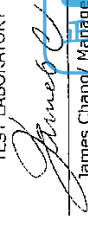

James Chang / Manager



各式文件，妥善保存

Quietek
No.75-2, 3 Lin, Wang-Yeh Valley, Yung-Hsing Tsuen, Chung-Lin Shiang, Hsin-Chu 307 Taiwan, R.O.C.
TEL: +886-3-592-8858 FAX: +886-3-592-8859 Email: service@quietek.com http://www.quietek.com



CERTIFICATE

Issued Date: Dec. 28, 2004
Report No.: 051H003F

This is to certify that the following designated product

Product	: POWER INVERTER
Trade name	: COTEK
Model Number	: ST1000-112, ST1000-124, ST1000-148
Company Name	: COTEK ELECTRONIC IND. CO., LTD.

This product, which has been issued the test report listed as above in Quietek Laboratory, is based on a single evaluation of one sample and confirmed to comply with the requirements of the following EMC standard.

FCC CFR Title 47 Part 15 Subpart B: 2003, CISPR 22:1997

TEST LABORATORY



James Chang / Manager

Quietek
No.75-2, 3 Lin, Wang-Yeh Valley, Yung-Hsing Tsuen, Chung-Lin Shiang, Hsin-Chu 307 Taiwan, R.O.C.
TEL: +886-3-592-8858 FAX: +886-3-592-8859 Email: service@quietek.com http://www.quietek.com





CERTIFICATE

Issued Date: Jun. 21, 2005
Report No.: 056H088F

This is to certify that the following designated product

Product : POWER INVERTER
Trade name : COTEK
Model Number : ST2500-112, ST2500-124, ST2500-148
Company Name : COTEK ELECTRONIC IND. CO., LTD.

This product, which has been issued the test report listed as above in Quietek Laboratory, is based on a single evaluation of one sample and confirmed to comply with the requirements of the following EMC standard.

FCC CFR Title 47 Part 15 Subpart B: 2003, CISPR 22:1997

TEST LABORATORY

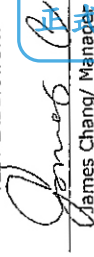
James Chang/ Manager



CERTIFICATE

Issued Date: Jun. 21, 2005
Report No.: 056H086F

This is to certify that the following designated product

Product : POWER INVERTER
Trade name : COTEK
Model Number : ST2000-112, ST2000-124, ST2000-148
Company Name : COTEK ELECTRONIC IND. CO., LTD.

This product, which has been issued the test report listed as above in Quietek Laboratory, is based on a single evaluation of one sample and confirmed to comply with the requirements of the following EMC standard.

FCC CFR Title 47 Part 15 Subpart B: 2003, CISPR 22:1997

TEST LABORATORY

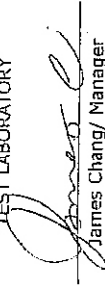
James Chang/ Manager





e13*72/245*95/54*2967*00

M₁, M₂, M₃, N₁, N₂, N₃, O₁, O₂, O₃, O₄,

Cotek Electronic Industrial Co., Ltd.
No. 33, Rong Hsin Rd., Pa. Teh City,
Tao Yuan County, Taiwan,
R.O.C.

Label fixed on the bottom of the inverter

Cotek (Shenzhen) Electronic Co.
Heng Ling Industrial Park, Ming Zhi Village,
Long Hua Town, Pao An Area,
Shenzhen, Guang Dong,
P.R. CHINA

0.4. Catégorie de véhicule: ⁽³⁾
Category of vehicle:

0.5. Norm et adresse du constructeur:
Name and address of manufacturer:

0.7. Dans le cas de composants et d'entités techniques, emplacement et procédé de fixation de la marque de réception CEE:
In the case of components and separate technical units, location and method of affixing of the EEC approval mark:

0.8. Adresse(s) de l'(des) usine(s) d'assemblage:
Address(es) of assembly plant(s):

¹ Rayer la mention inutile
Delete where not applicable
² Si les moyens d'identification du type comportent des caractères non pertinents pour décrire les types de véhicules, de composants ou d'entité technique visés par la présente fiche de réception, ces caractères sont remplacés par le symbole "???" dans la documentation (par exemple: ABE??123??).
If the means of identification of type contains characters not relevant to describe the vehicle, component or separate technical unit types covered by this certificate, such characters shall be represented in the documentation by the symbol "???" (e.g. ABE??123??).
³ Selon les définitions de l'annexe II/A de la directive 70/156/CEE.
As defined in Annex II A to Directive 70/156/EEC.

GRAND-DUCHÉ DE LUXEMBOURG

MINISTÈRE DES TRANSPORTS

Luxembourg, le 10 octobre 2005
19-21, Boulevard Royal
L-2220 Luxembourg
Tél. 74 11 | Téléfax 241 817 - Télex 1465 CIVAIR LU

REFERENCE: e13*72/245*95/54*2967*00

ANNEXES: Documentation technique



Certificat de réception CE par type EC Type Approval Certificate

Communication concernant: ⁽³⁾
Communication concerning the:

- la réception par type
type-approval
- l'extension de la réception par type
extension-of-type-approval
- le refus de la réception par type
refusal-of-type-approval
- le retrait de la réception par type
withdrawal-of-type-approval

d'un type de véhicule / composant / entité technique ⁽¹⁾ en ce qui concerne la directive 72/245/CEE conformément au dernier amendement par la directive 95/54/CE.
of a type of vehicle / component / separate technical unit with regard to Directive 72/245/EEC, as last amended by Directive 95/54/EC.

Numéro de réception par type:
Type-approval number:

e13*72/245*95/54*2967*00

Raison(s) de l'extension:
Reason(s) for extension:

Not applicable

Section I Section 1

0.1. Fabricant (marque commerciale du constructeur):
Maker (trade name of manufacturer):

COTEK

0.2. Type:
Type:

ST1000

Description(s) commerciale(s) générale(s):
General commercial description(s):

Pure sine wave inverter

Version(s)/Varianté(s):
Version(s)/Variant(s):

ST1000-212, ST1000-224, ST1000-248

0.3. Moyens d'identification du type, s'ils sont marqués sur le véhicule / composant / entité technique: ^(1,2)
Means of identification of type, if marked on the vehicle / component / separate technical unit:

ST1000-2??

0.3.1. Emplacement de ce marquage:
Location of that marking:

On the bottom of the inverter



GRAND-DUCHÉ DE LUXEMBOURG

MINISTÈRE DES TRANSPORTS

Luxembourg, le 13 octobre 2005
 19-21, Boulevard Royal
 L-2910 Luxembourg
 Tél. 4788-1 - Télécopieur 241 817 - Télex 1465 CIVAIR LU

REFERENCE: e13*72/245*95/54*3176*00

ANNEXES: Documentation technique



Certificat de réception CE par type
 EC Type-Approval Certificate

1. Informations supplémentaires (s'il y a lieu): See appendix

2. Autorité déléguée: Assigned authority: Société Nationale de Certification et d'Homologation
 L-5230 Sandweiler

Service technique responsable de l'exécution des essais: Technical service responsible for carrying out the tests: TÜV Rheinland Luxembourg GmbH
 Centre Commercial "Le 2000" Z.I.
 L-3378 Livange

3. Date du rapport d'essai: Date of test report: 04.10.2005

4. Numéro du rapport d'essai: Number of test report: 84-72/245-00201/05

5. Remarques (s'il y a lieu): Remarks (if any): Not applicable

6. Lieu: Place: Luxembourg

7. Date: Date: 10 octobre 2005

8. Signature: Signature: 
 Pour le Ministre des Transports
 Paul SCHMIT
 Commissaire du Gouvernement

9. L'index de l'ensemble des renseignements déposés chez l'autorité de réception, qui peut être obtenu sur demande, est joint.
 The index to the information package lodged with the approval authority, which may be obtained on request, is attached.

See index to type-approval report

Communication concerning: ⁽¹⁾
 Communication concerning the:
 - la réception par type
 Type-approval
 - l'extension de la réception par type
 Extension of type-approval
 - le refus de la réception par type
 Refusal of type-approval
 - le retrait de la réception par type
 Withdrawal of type-approval

d'un type de véhicule / composant / entité technique ⁽¹⁾ en ce qui concerne la directive 72/245/CEE conformément au dernier amendement par la directive 95/54/CE,
 of a type of vehicle / component / separate technical unit with regard to Directive 72/245/EEC, as last amended by Directive 95/54/EC.

Numéro de réception par type: Type-approval number: e13*72/245*95/54*3176*00

Raison(s) de l'extension: Reason(s) for extension: Not applicable

Section I
 Section I

0.1. Fabricant (marque commerciale du constructeur): Make (trade name of manufacturer): COTEK

0.2. Type: Type: ST1500-248

Description(s) commerciale(s) générale(s): General commercial description(s): DC-AC Pure sine wave inverter

Variante(s)/Variant(s): Variant(s)/Variant(s): ST1500-212, ST1500-224

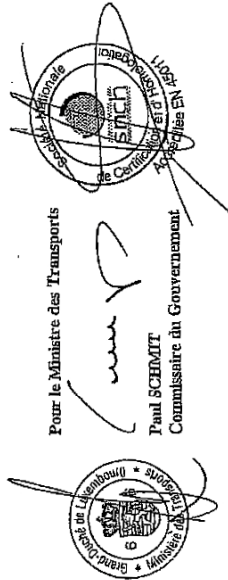
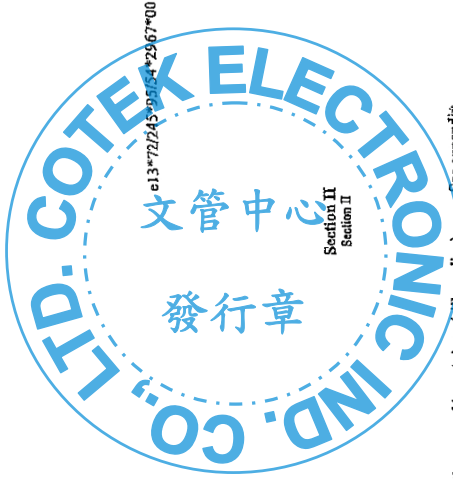



e13*727245*95/54*3176*00

Section II
Section II



e13*727245*95/54*3176*00

Identification is done by type name

Sticker on top side of the inverter

Not applicable

Cotek (Shenzhen) Electronic Co., Ltd.
Longshen 22, Enter Frise Road,
Longshua, Baoan, Shenzhen,
P.R. CHINA

Sticker affixed clearly legible and indelible on back side of the inverter

Cotek (Shenzhen) Electronic Co., Ltd.
Longshen 22, Enter Frise Road,
Longshua, Baoan, Shenzhen,
P.R. CHINA

1. Informations supplémentaires (s'il y a lieu):
Additional information (where applicable): See appendix

2. Autorité déléguée:
Assigned authority: Société Nationale de Certification et d'Homologation
L-5230 Sandweiler

3. Service technique responsable de l'exécution des essais:
Technical service responsible for carrying out the tests: Société Nationale de Certification et d'Homologation
11, route de Luxembourg
L-5230 Sandweiler

4. Date du rapport d'essai:
Date of test report: 19.09.2005

5. Numéro du rapport d'essai:
Number of test report: 250414

6. Remarques (s'il y a lieu):
Remarks (if any): Not applicable

7. Lieu:
Place: Luxembourg

8. Date:
Date: 13 octobre 2005

9. Signature:
Signature: Pour le Ministre des Transports
Paul SCHMIT
Commissaire du Gouvernement

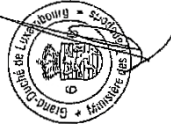

L'index de l'ensemble des renseignements déposé chez l'autorité de réception, qui peut être obtenu sur demande, est joint.
The index to the information package lodged with the approval authority, which may be obtained on request, is attached.

See index to type-approval report



0.3. Moyens d'identification du type, s'ils sont marqués sur le véhicule / composant / entité technique (1, 2):
Means of identification of type, if marked on the vehicle / component / separate technical unit.

0.3.1. Emplacement de ce marquage:
Location of that marking:

0.4. Catégorie de véhicule:
Category of vehicle:

0.5. Nom et adresse du constructeur:
Name and address of manufacturer:

0.7. Dans le cas de composants et d'entités techniques, emplacement et procédé de fixation de la marque de réception CEE:
In the case of components and separate technical units, location and method of affixing of the EEC approval mark:

0.8. Adresse(s) de l'(des) usine(s) d'assemblage:
Address(es) of assembly plant(s):

¹ Rayer la mention inutile
Delete where not applicable

² Si les moyens d'identification du type comportent des caractères non inclinaillés pour décrire les types de véhicules, de composants ou d'entité technique visés par la présente fiche de réception, ces caractères sont remplacés par le symbole "X" dans la documentation (voir exemple: ABC712347).

³ Le moyen d'identification de type mentionné ci-dessus ne concerne que le véhicule, le composant ou l'entité technique, tel qu'il est représenté dans la documentation par le symbole "X" (voir exemple: ABC712347).

⁴ Selon les définitions de l'Annexe II A de la directive 70/156/CEE.

As defined in Annex II A to Directive 70/156/EEC.



e13*72/245*95/54*3177*00

Identification is done by type name

Sticker on top side of the inverter

Not applicable

Cotek (Shenzhen) Electronic Co., Ltd.
Longshan 22, Enter Prise Road,
Longshan, Baoan, Shenzhen,
P.R. CHINA

Sticker affixed clearly legible and indelible on back side of the inverter

Cotek (Shenzhen) Electronic Co., Ltd.
Longshan 22, Enter Prise Road,
Longshan, Baoan, Shenzhen,
P.R. CHINA



0.3. Moyens d'identification du type, s'ils sont marqués sur le véhicule / composant / entité-technique: (1,3)
Means of identification of type, if marked on the vehicle / component / separate-assembly-unit:

0.3.1. Emplacement de ce marquage:
Location of that marking:

0.4. Catégorie de véhicule: (3)
Category of vehicle:

0.5. Nom et adresse du constructeur:
Name and address of manufacturer:

0.7. Dans le cas de composants et d'entités techniques, emplacement et procédé de fixation de la marque de réception CEE:
In the case of components and separate technical units, location and method of affixing of the EEC approval mark:

0.8. Adresse(s) de l'(des)usine(s) d'assemblage:
Address(es) of assembly plant(s):

* Réviser la section inutile

* Delete where not applicable

* Si les moyens d'identification du type comportent des caractères non pertinents pour décrire le type de véhicule, de composant ou d'entité-technique, par exemple l'acronyme de l'entreprise, ces caractères sont remplacés par le symbole "X" dans le document technique.

If the means of identification of type contain characters not relevant to describe the vehicle, component or separate technical unit types covered by this certificate, such characters shall be replaced in this document by the symbol "X" (e.g. ABCXYZ1237).

* Selon les définitions de l'annexe II A de la directive 70/156/CEE.

As defined in Annex II A to Directive 70/156/EEC.

Luxembourg, le 13 octobre 2005

1921, Boulevard Royal

L-2110 Luxembourg

Tel: 47811 - Télécopieur 241 817 - Télax: 1465 CIVAAR LU

MINISTÈRE DES TRANSPORTS

REFERENCE: e13*72/245*95/54*3177*00

ANNEXE: Documentation technique



Certificat de réception CE par type

EC Type-Approval Certificate

Communication concernant: (3)
Communication concerning the:

- la réception par type
- Type-approval
- l'extension de la réception par type
- Extension of type approval
- le refus de la réception par type
- Refusal of type approval
- le retrait de la réception par type
- Withdrawal of type approval

d'un type de véhicule / composant / entité-technique (1) en ce qui concerne la directive 72/245/CEE conformément au dernier amendement par la directive 95/54/CE.

of a type of vehicle / component / separate-assembly-unit with regard to Directive 72/245/EEC, as last amended by Directive 95/54/EC.

Número de réception par type:
Type-approval number:

e13*72/245*95/54*3177*00

Raison(s) de l'extension:
Reason(s) for extension:

Not applicable

0.1. Fabricant (marque commerciale du constructeur):
Maker (trade name of manufacturer):

COTEK

0.2. Type:

ST2000-224

Description(s) commerciale(s) générale(s):
General commercial description(s):

DC-AC Pure sine wave inverter

Version(s) / Variante(s):
Version(s) / Variant(s):

ST2000-212, ST2000-248

Section I
Section I

GRAND-DUCHÉ DE LUXEMBOURG

MINISTÈRE DES TRANSPORTS

Luxembourg, le 13 octobre 2005
19-21, Boulevard Royal
L-2910 Luxembourg
Tél. 478-1 - Téléfax 241 817 - Télec. 1465 CIVAUR. LU -

REFERENCE: e13*72245*95/54*3178*00

ANNEXES: Documentation technique



Certificat de réception CE par type
EC Type-Approval Certificate

Communication concernant: (1)
Communication concerning the:
- la réception par type / type-approval
- l'extension de la réception par type / extension of type-approval
- le refus de la réception par type / refusal of type-approval
- le retrait de la réception par type / withdrawal of type-approval

d'un type de véhicule / composant / entité technique (1) en ce qui concerne la directive 72/245/CEE conformément au dernier amendement par la directive 95/54/CE.
of a type of vehicle / component / separate technical unit with regard to Directive 72/245/EEC, as last amended by Directive 95/54/EC.

Numéro de réception par type: e13*72245*95/54*3178*00
Type-approval number:

Raison(s) de l'extension: Not applicable
Reason(s) for extension:

Section I
Section 1

- 0.1. Fabricant (marque commerciale du constructeur): COTEK
Make (trade name of manufacturer):
- 0.2. Type: ST2500-212
Description(s) commerciale(s) générale(s): DC-AC Pure sine wave inverter
General commercial description(s):
Version(s)/Variant(e): ST2500-224, ST2500-248
Version(s)/Variant(e):



e13*72245*95/54*3177*00

Section II
Section 2

文管中心
發行章

1. Informations supplémentaires (s'il y a lieu): See appendix
Additional information (where applicable):
2. Autorité désignée: Société Nationale de Certification et d'Homologation
Assigned authority: L-5230 Sandweiler
3. Services technique responsable de l'exécution des essais: Société Nationale de Certification et d'Homologation
Technical service responsible for carrying out the tests: L-5230 Sandweiler
4. Date du rapport d'essai: 19.09.2005
Number of test report: 250413
5. Remarques (s'il y a lieu): Not applicable
Remarks (if any):
6. Lieu: Luxembourg
Place:
7. Date: 13 octobre 2005
Date:
8. Signatures: Pour le Ministre des Transports
Signature: Paul SCHEMIT
Commissaire du Gouvernement
9. L'index de l'ensemble des renseignements déposés chez l'autorité de réception, qui peut être obtenu sur demande, est joint.
The index to the information package lodged with the approval authority, which may be obtained on request, is attached.
See index to type-approval report

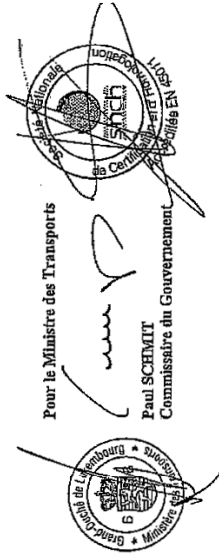



913*7245*95/54*3178*00

Section II
Section II



913*7245*95/54*3178*00



0.3. Moyens d'identification du type, s'ils sont marqués sur le véhicule / composant / pièce technique: 0-3
Means of identification of type, if marked on the vehicle / component / separate technical unit.

0.3.1. Emplacement de ce marquage:
Location of the mark:

0.4. Catégorie de véhicule:
Category of vehicle:

0.5. Nom et adresse du constructeur:
Name and address of manufacturer:

0.7. Dans le cas de composants et d'entités techniques, emplacement et procédé de fixation de la marque de réception CRE:
In the case of components and separate technical units, location and method of affixing of the CRE approval mark:

0.8. Adresse(s) de l'(des)usine(s) d'assemblage:
Address(es) of assembly plant(s):

Identification is done by type name

Sticker on top side of the inverter

Not applicable

Cotek (Shenzhen) Electronic Co., Ltd.
Longshan 22, Enter Frise Road,
Longshan, Baoan, Shenzhen,
P.R. CHINA

Sticker affixed clearly legible and indelible on back side of the inverter

Cotek (Shenzhen) Electronic Co., Ltd.
Longshan 22, Enter Frise Road,
Longshan, Baoan, Shenzhen,
P.R. CHINA

1. Informations supplémentaires (s'il y a lieu):
Additional information (where applicable):

2. Autorité déléguée:
Assigned authority:

Service technique responsable de l'exécution des essais:
Technical service responsible for carrying out the tests:

3. Date du rapport d'essai:
Date of test report:

4. Numéro du rapport d'essai:
Number of test report:

5. Remarques (s'il y a lieu):
Remarks (if any):

6. Lieu:
Place:

7. Date:
Date:

8. Signature:
Signature:

9. L'index de l'ensemble des renseignements déposés chez l'autorité de réception, qui peut être obtenu sur demande, est joint.
The index to the information package lodged with the approval authority, which may be obtained on request, is attached.

Sec index to type-approval report



¹ Réviser la nomenclature finale
Dates when not applicable
² Si les moyens d'identification du type comportent des caractères non pertinents pour décrire le type de véhicule, le composant ou d'entité technique visés par la présente fiche de réception, ces caractères sont remplacés par le symbole "077" dans la documentation (par exemple: A31C7112377).
If the means of identification of type contain characters not relevant to describe the vehicle, component or separate technical unit types covered by this certificate, such characters shall be replaced in the documentation by the symbol "077" (e.g. A31C7112377).
³ Selon les définitions de l'Annexe II, A.60.3a. de l'directive 76/756/CEE.
As defined in Annex II, A.60.3a. of Directive 76/756/EEC.

Signature: Paul SCHMIT
Commissaire du Gouvernement
Pour le Ministre des Transports
13 octobre 2005
Luxembourg



CERTIFICATE

Issued Date: Dec. 30, 2004
Report No.: 051H002E

This is to certify that the following designated product

Product : POWER INVERTER
Trade name : COTEK
Model Number : ST1500-212, ST1500-224, ST1500-248
Company Name : COTEK ELECTRONIC IND. CO., LTD.

This product, which has been issued the test report listed as above in Quietek Laboratory, is based on a single evaluation of one sample and confirmed to comply with the requirements of the following EMC standard.

- EN 55022: 1998+A1: 2000
- EN 61000-3-2: 2000
- EN 61000-3-3: 1995 + A1: 2001
- EN 55024: 1998+A1: 2001
- IEC 61000-4-2: 1995+A1: 1998+A2: 2000
- IEC 61000-4-3: 1995+A1: 1998+A2: 2000
- IEC 61000-4-4: 1995+A1: 2000+A2: 2001
- IEC 61000-4-5: 1995+A1: 2000
- IEC 61000-4-6: 1996+A1: 2000
- IEC 61000-4-8: 1993+A1: 2000
- IEC 61000-4-11: 1994+A1: 2000

TEST LABORATORY

James Chang
James Chang/ Manager



CERTIFICATE

Issued Date: Jan. 03, 2005
Report No.: 051H004E

This is to certify that the following designated product

Product : POWER INVERTER
Trade name : COTEK
Model Number : ST1000-212, ST1000-224, ST1000-248
Company Name : COTEK ELECTRONIC IND. CO., LTD.

This product, which has been issued the test report listed as above in Quietek Laboratory, is based on a single evaluation of one sample and confirmed to comply with the requirements of the following EMC standard.

- EN 55022: 1998+A1: 2000
- EN 61000-3-2: 2000
- EN 61000-3-3: 1995 + A1: 2001
- EN 55024: 1998+A1: 2001
- IEC 61000-4-2: 1995+A1: 1998+A2: 2000
- IEC 61000-4-3: 1995+A1: 1998+A2: 2000
- IEC 61000-4-4: 1995+A1: 2000+A2: 2001
- IEC 61000-4-5: 1995+A1: 2000
- IEC 61000-4-6: 1996+A1: 2000
- IEC 61000-4-8: 1993+A1: 2000
- IEC 61000-4-11: 1994+A1: 2000

TEST LABORATORY

James Chang
James Chang/ Manager





CERTIFICATE

Issued Date: Jun. 23, 2005
Report No.: 056H087E

This is to certify that the following designated product

Product : POWER INVERTER
Trade name : COTEK
Model Number : ST2500-212, ST2500-224, ST2500-248
Company Name : COTEK ELECTRONIC IND. CO., LTD.

This product, which has been issued the test report listed as above in Quietek Laboratory, is based on a single evaluation of one sample and confirmed to comply with the requirements of the following EMC standard.

- EN 55022: 1998+A1: 2000+A2: 2003 EN 55024: 1998+A1: 2001+A2: 2003
- IEC 61000-3-2: 2000 IEC 61000-4-2: 1995+A1: 1998+A2: 2000
- EN 61000-3-3: 1995 + A1: 2001 IEC 61000-4-3: 2002+A1: 2002
- IEC 61000-4-4: 2004 IEC 61000-4-4: 2004
- IEC 61000-4-5: 1995+A1: 2000 IEC 61000-4-5: 1995+A1: 2000
- IEC 61000-4-6: 1996+A1: 2000 IEC 61000-4-6: 1996+A1: 2000
- IEC 61000-4-8: 1993+A1: 2000 IEC 61000-4-8: 1993+A1: 2000
- IEC 61000-4-11: 1994+A1: 2000 IEC 61000-4-11: 1994+A1: 2000

TEST LABORATORY

James Chang
James Chang/ Manager



Quietek No.75-2, 3 Lin, Wang-Yeh Valley, Yung-Hsing Tsuen, Chung-Lin Shiang, Hsin-Chu 307 Taiwan, R.O.C.
TEL: +886-3-592-8858 FAX: +886-3-592-8859 Email: service@quietek.com http://www.quietek.com



CERTIFICATE

Issued Date: Jun. 22, 2005
Report No.: 056H069E

This is to certify that the following designated product

Product : POWER INVERTER
Trade name : COTEK
Model Number : ST2000-212, ST2000-224, ST2000-248
Company Name : COTEK ELECTRONIC IND. CO., LTD.

This product, which has been issued the test report listed as above in Quietek Laboratory, is based on a single evaluation of one sample and confirmed to comply with the requirements of the following EMC standard.

- EN 55022: 1998+A1: 2000+A2: 2003 EN 55024: 1998+A1: 2001+A2: 2003
- IEC 61000-3-2: 2000 IEC 61000-4-2: 1995+A1: 1998+A2: 2000
- EN 61000-3-3: 1995 + A1: 2001 IEC 61000-4-3: 2002+A1: 2002
- IEC 61000-4-4: 2004 IEC 61000-4-4: 2004
- IEC 61000-4-5: 1995+A1: 2000 IEC 61000-4-5: 1995+A1: 2000
- IEC 61000-4-6: 1996+A1: 2000 IEC 61000-4-6: 1996+A1: 2000
- IEC 61000-4-8: 1993+A1: 2000 IEC 61000-4-8: 1993+A1: 2000
- IEC 61000-4-11: 1994+A1: 2000 IEC 61000-4-11: 1994+A1: 2000

TEST LABORATORY

James Chang
James Chang/ Manager



Quietek No.75-2, 3 Lin, Wang-Yeh Valley, Yung-Hsing Tsuen, Chung-Lin Shiang, Hsin-Chu 307 Taiwan, R.O.C.
TEL: +886-3-592-8858 FAX: +886-3-592-8859 Email: service@quietek.com http://www.quietek.com

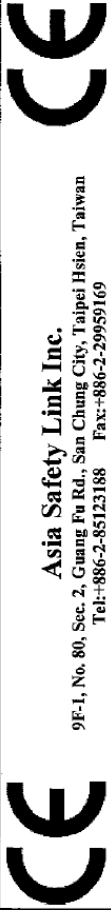

Asia Safety Link Inc.
9F-1, No. 80, Sec. 2, Guang Fu Rd., San Chung City, Taipei Hsien, Taiwan
Tel: +886-2-85123188 Fax: +886-2-29959169

Certificate of Compliance

Low Voltage Directive 73/23/EEC and the Amendment Directive 93/68/EEC

Certificate Number: 94-1003

Manufacturer: Cotek Electronic Ind. Co., Ltd.
No. 33, Rong Hsin Rd., Pa The city, Taoyuan Country, Taiwan

Product: Power Inverter

Model/Type: ST1500-212, ST1500-224, ST1500-248

Electrical Rating: ip: (1) 10.5-15Vdc, 165A (ST1500-212)
(2) 21-30Vdc, 82A (ST1500-224)
(3) 42-60Vdc, 40A (ST1500-248)
op: 220/230/240Vac, 50/60Hz, 1500W

Other Specification:

Standards applied: IEC 60950-1: 2001; EN 60950-1: 2001

The tested samples of the above products are in conformity with the technical provisions of the Following European Directive -

- Low Voltage Directive 73/23/EEC and the Amendment Directive 93/68/EEC-
Date Issued: February 27, 2006

Approve & Authorized Signer: 
Jeff Chang



Asia Safety Link Inc.
9F-1, No. 80, Sec. 2, Guang Fu Rd., San Chung City, Taipei Hsien, Taiwan
Tel: +886-2-85123188 Fax: +886-2-29959169

Certificate of Compliance

Low Voltage Directive 73/23/EEC and the Amendment Directive 93/68/EEC

Certificate Number: 94-1002

Manufacturer: Cotek Electronic Ind. Co., Ltd.
No. 33, Rong Hsin Rd., Pa The city, Taoyuan Country, Taiwan

Product: Power Inverter

Model/Type: ST1000-212, ST1000-224, ST1000-248

Electrical Rating: ip: (1) 10.5-15Vdc, 110A (SK1000-212)
(2) 21-30Vdc, 54A (SK1000-224)
(3) 42-60Vdc, 26A (SK1000-248)
op: 220/230/240Vac, 50/60Hz, 1000W

Other Specification:

Standards applied: IEC 60950-1: 2001; EN 60950-1: 2001

The tested samples of the above products are in conformity with the technical provisions of the Following European Directive -

- Low Voltage Directive 73/23/EEC and the Amendment Directive 93/68/EEC-
Date Issued: January 12, 2006

Approve & Authorized Signer: 
Jeff Chang



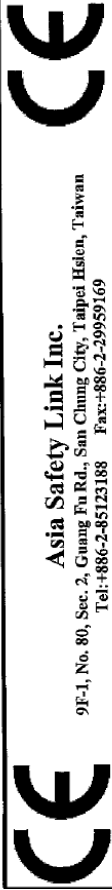

Asia Safety Link Inc.
9F-1, No. 80, Sec. 2, Guang Fu Rd., San Chung City, Taipei Hsien, Taiwan
Tel: +886-2-45121388 Fax: +886-2-49959169

Certificate of Compliance

Low Voltage Directive 2006/95/EC

Certificate Number: 95-0829

Manufacturer: Cotek Electronic Ind. Co., Ltd.
No. 33, Rong Hsin Rd., Pa The city, Taoyuan Country, Taiwan

Product: Power Inverter

Model/Type: ST2000-x, x=212, 224 or 248

Electrical Rating: ip: AC 220/230/240, 50/60Hz, 30A or
DC 10.5-15V, 230A / 21-30V, 108A / 42-60V, 52A
op: AC 220/230/240V, 50/60Hz, 2000W

Other Specification:

Standards applied: IEC 60950-1: 2001; EN 60950-1: 2001

The tested samples of the above products are in conformity with the technical provisions of the Following European Directive -

Low Voltage Directive 2006/95/EC

Date Issued: May 22, 2007

Approve & Authorized Signer:

Jeff Chang



Asia Safety Link Inc.
9F-1, No. 80, Sec. 2, Guang Fu Rd., San Chung City, Taipei Hsien, Taiwan
Tel: +886-2-45121388 Fax: +886-2-49959169

Certificate of Compliance

Low Voltage Directive 2006/95/EC

Certificate Number: 95-0830

Manufacturer: Cotek Electronic Ind. Co., Ltd.
No. 33, Rong Hsin Rd., Pa The city, Taoyuan Country, Taiwan

Product: Power Inverter

Model/Type: ST2500-x, x=212, 224 or 248

Electrical Rating: ip: AC 220/230/240, 50/60Hz, 30A or
DC 10.5-15V, 262A / 21-30V, 126A / 42-60V, 63A
op: AC 220/230/240V, 50/60Hz, 2500W

Other Specification:

Standards applied: IEC 60950-1: 2001; EN 60950-1: 2001

The tested samples of the above products are in conformity with the technical provisions of the Following European Directive -

Low Voltage Directive 2006/95/EC

Date Issued: May 23, 2007

Approve & Authorized Signer:

Jeff Chang

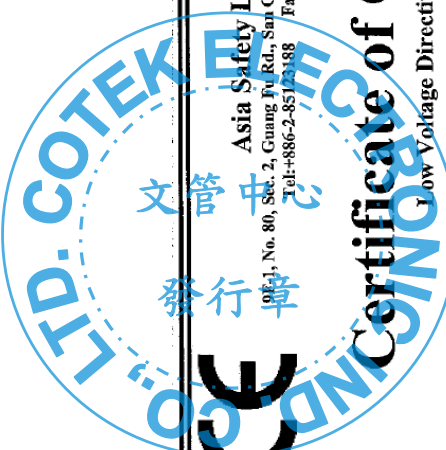

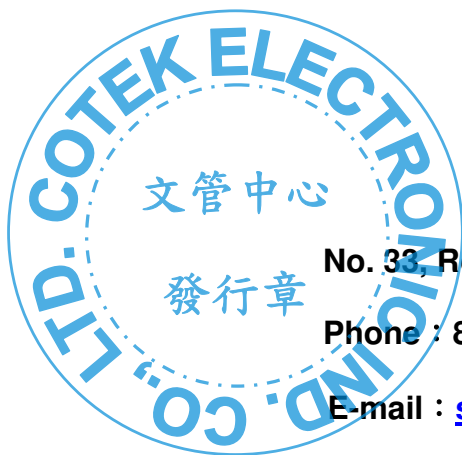

COTEK

No. 33, Rong Hsin Rd., Pa Teh City, Tao Yuan County, Taiwan

Phone : 886-3-3661581 FAX : 886-3-3676029

E-mail : sales@cotek.com.tw http : // www.cotek.com.tw

2011.01._A1

