



MNBE-8D2x2 INSTRUCTIONS



MNBE-8D2x2 OUTDOOR 3R ENCLOSURE

MNBE-8D2x2

Battery Enclosure with locking door and one shelf. Outdoor 3R rain type design. Powder coated aluminum and stainless steel construction. Holds four 8D batteries. Has spaces for a single 175 or 250 amp battery breaker and up to 4 MNDC panel mount breakers (1 to 100 amps available).
Breakers not included
Ships un-assembled.

MNBE-8D2x2 Deluxe

Battery Enclosure with locking door and one shelf. Outdoor 3R rain type design. Powder coated aluminum and stainless steel construction. Holds four 8D batteries. Comes with 250 amp battery breaker, 2 of our 4/0 12 inch cables and a single 36 inch 4/0 cable for interconnecting the batteries. It also has spaces for up to 4 MNDC panel mount breakers (1 to 100 amps available).
Ships un-assembled.

IMPORTANT SAFETY INSTRUCTIONS

SAVE THESE INSTRUCTIONS - These instructions contain important safety and operating instructions for the MidNite Solar MNBE-8D2x2 and MNBE-8D2x2-Deluxe Battery Enclosures for residential and commercial applications.

If you do not fully understand any of the concepts, terminology, or hazards outlined in these instructions, please refer installation to a qualified dealer, electrician or installer. These instructions are not meant to be a complete explanation of a renewable energy system.

GENERAL PRECAUTIONS

WORKING WITH OR IN THE VICINITY OF A LEAD ACID BATTERY, SEALED OR VENTED IS DANGEROUS. VENTED BATTERIES GENERATE EXPLOSIVE GASES DURING NORMAL OPERATION. FOR THIS REASON, IT IS VERY IMPORTANT THAT BEFORE SERVICING EQUIPMENT IN THE VICINITY OF LEAD-ACID BATTERIES, YOU REVIEW AND FOLLOW THESE INSTRUCTIONS CAREFULLY.

If service or repair should become necessary, contact MidNite solar Inc. Improper servicing may result in a risk of shock, fire or explosion. To reduce these risks, disconnect all wiring before attempting any maintenance or cleaning. Turning off the inverter will not reduce these risks. Solar modules produce power when exposed to light. When it is not possible to disconnect the power coming from the Photovoltaics by an external means such as a combiner, cover the modules with an opaque material before servicing any connected equipment.

Never attempt to charge a frozen battery. When it is necessary to remove a battery, make sure that the battery bank disconnect breaker is in the off position and that the PV breakers, grid breakers and any other sources of power to the inverter are in the off position. Then remove the negative terminal from the battery first.

To reduce risk of battery explosion follow these instructions and those published by the battery manufacturer as well as the manufacturer of any additional equipment used in the vicinity of the batteries. Before installing the battery enclosure, read all instructions and cautionary markings in or on any connected electrical equipment.

Avoid producing sparks in the vicinity of the batteries when using vented batteries. Provide ventilation to clear the area of explosive gases. Sealed AGM and Gel batteries do not under normal conditions create explosive gases. Be especially cautious when using metal tools. Dropping a metal tool onto batteries can short circuit them. The resulting spark can lead to personal injury or damage to the equipment. Provide ventilation to outdoors from the battery compartment when installing vented batteries such as golf cart T-105 batteries. The addition of a spill tray is also a good idea.

Clean all battery terminals. Very high currents are drawn from the batteries; even a small amount of electrical resistance can result in overheating, poor performance, premature failure or even fire.

Have plenty of fresh water and soap nearby in case battery acid contacts skin, clothing or eyes. Wear complete eye and clothing protection. Always avoid touching eyes while working near batteries. If battery acid or battery terminal corrosion contacts skin or clothing, wash immediately with soap and water. If acid enters the eyes, immediately flood with cool running water for at least 15 minutes and get medical attention immediately. Baking soda neutralizes battery acid electrolyte. Keep a supply near the batteries.

Do not work alone. Someone should be in the range of your voice or close enough to come to your aid when you work with or near electrical equipment.

Remove rings, bracelets, necklaces, watches etc. when working with batteries, photovoltaic modules or other electrical equipment. Power from an illuminated photovoltaic array makes a very effective arc welder with dire consequences if one of the welded pieces is on your person.

To reduce the risk of injury, connect only deep cycle lead acid type rechargeable batteries. Other types of batteries may leak or burst, causing personal injury or damage.

INSTRUCTIONS DE SECURITÉ IMPORTANTES

CONSERVER CES INSTRUCTIONS

Ces instructions contiennent des informations importantes pour utiliser le Midnite Solar SMA MNX-240 Autotransformer en toute sécurité.

1. Avant l'utilisez cet appareil lis et comprends toutes les instructions et avertissements.
2. Si vous ne comprenez pas l'une des concepts ou des instructions contenu dans cette manuel consulter un agent spécialisé.
3. Si des réparations sont nécessaires contactez MidNite Solar pour plus des informations. Danger de choc électrique et de risque de brulure. Rien à dépanner à l'intérieure du cette appareil. Ne pas ouvrir le couver. Pour toute réparation ou service d'entretien, consulter un agent spécialisé. Il y'a peut-être plusieurs sources d'alimentation dans cette system. Débrancher toutes les interrupteurs avant toute d'entretien où nettoyage.
4. Ne travaillez pas seul. Quelqu'un devrait toujours être à proximité pour aider en cas d'une situation d'urgence.
5. Retirer bagues, bracelets, colliers, montres, et quelles choses comme ça. Il y'a risque des blessures graves s'il y'a un court-circuit. Cela pourrait ruiner votre journée entière.
6. Le câblage doit être fait en conformité avec le National Electrical Code ANSI / NFPA 70. Utiliser des méthodes de câblage de catégorie 1 pour les connexions de câblage sur .des terminaux d'un circuit de classe 2. Utilisez uniquement des fils de AWM de calibre 14-1/0. Sélectionnez le type de câble utilisé sur la base de la protection prévue par les disjoncteurs / fusibles.

Table of Contents

Warnings 2

Unpacking..... 4

Assembly 4

Wiring – Battery Configuration 7

Circuit Breaker Selection 7

Assembly drawing..... 8

Battery Arrangement..... 9

Warranty 12

Unpacking

The MNBE-8D2x2 and MNBE-8D2x2-Deluxe each ship in two boxes. Unpacking is the same for each model except that the Deluxe model has extra components shipped within the shelf.

Before unpacking and assembly make sure there is enough space to work in comfortably. It is recommended to unpack the painted pieces onto carpet or other soft surface to avoid scratching.

Assembling the MNBE-8D2x2 and MNBE-8D2x2-Deluxe

Assembly of the MNBE-8D2x2 and MNBE8D2x2-Deluxe is essentially identical. The differences between the two models is that the deluxe model comes with extra components.

The MNBE-8D2x2 and Deluxe are 3R outdoor rated. In order to maximize rain-tightness, silicone sealant (Not included) is applied to several locations on the box during assembly.

General instructions below. Refer to the assembly drawing on page 7.

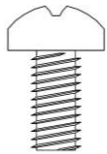

Panhead
Screw



Flathead
Screw

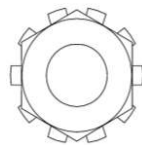

Nut



Lockwasher

Hardware identifier



Step 1:

Install each side to the shelf. The bottom has the flange bent outward. Use 1/4-20 x 0.50 flathead screws supplied.

MNBE-8D2x2 Instructions (continued)



Step 2:
Stand battery box upright. Line up the hinges on the door with the hinge pins on the battery box and lower the door onto the hinge pins.

Important!

The door must go on before the top cover.



Step 2 Continued:
Door Installed on Hinges



Step 3:
Apply silicone sealant (not included) around the entire top edge.



Step 3 continued:
Apply extra silicone sealant around holes and corners.



Step 4:
Install top to the sides as shown.
Use ¼-20 nuts supplied. (Door not shown)



Step 5:
Install bottom as shown. Use ¼-20 nuts supplied. (Door not shown)

MNBE-8D2x2 Instructions (continued)

Step 6: Install Lock.

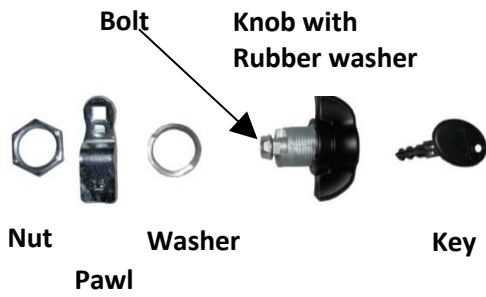

Door latch hardware

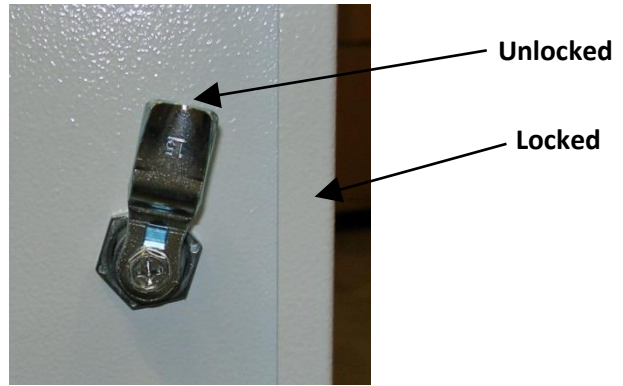

Lock mechanism viewed from the inside of the door.

Remove the **Bolt** from the end of the **Knob** and set aside.

Insert the **Knob** into the opening on the front of the door.

Place the **Washer** and **Nut** on the threads of the **Knob**, do not tighten.

Put the **pawl** on the end of the **Knob** and secure with the **Bolt** removed earlier.

Note: The **Knob** turns only a quarter turn. You will need to orient the **Knob** into the opening in the door so that it goes into the locked and unlocked positions shown. The **Knob** is usually set to be vertical when unlocked and horizontal when locked but this is not required.

Tighten the **Nut**.



Step 7:

Apply silicone sealant to top edge and install back cover, secure from the inside with $\frac{1}{4}$ Screws provided.



Step 8:

Install ground wire from the shelf to the door with #10 nuts provided.



Assembled, complete and ready for batteries.

When adding breakers use 10-32 X 3/8 screws with lockwashers for the battery disconnect breaker.

Use 6-32 X 5/16 screws with lockwashers for the C-Series panel mount breakers. Use of longer screws may result in damage to the breaker.

MNBE-8D2x2 Instructions (continued)

Wiring and Battery configuration.

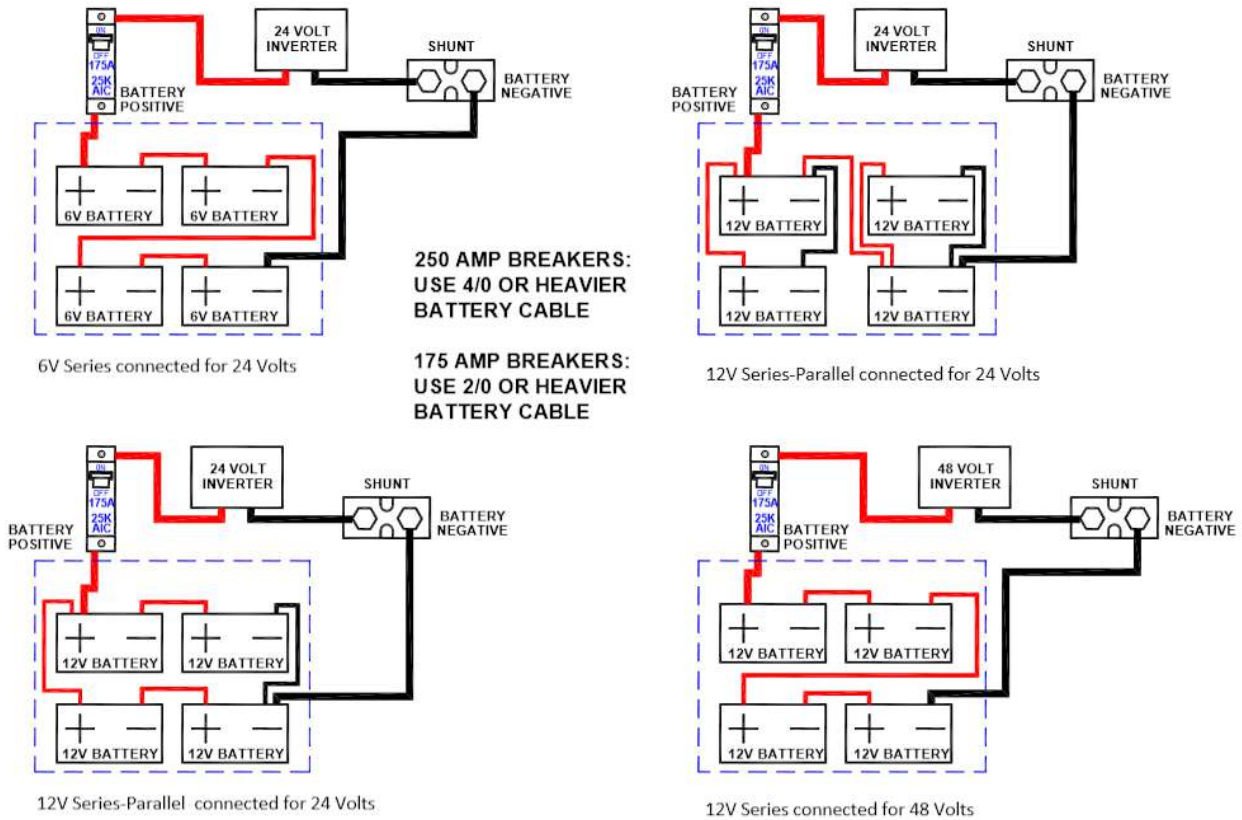

Above: Common battery configurations for 24 and 48 Volts.

IMPORTANT!

The circuit breaker *must* be in the positive lead.

IMPORTANT!

This enclosure contains circuit breakers that may arc or spark. Use only sealed AGM type batteries approved for use in an enclosure with electronic equipment. Other types may release hydrogen gas creating an explosion hazard.

Circuit breaker selection:

MidNite Solar DC disconnect circuit breakers are available in 175 and 250.
Order MNEDC175 or MNEDC250. An MNEDC250 is included with the Deluxe.

Panel mount breakers are available from 5-100 Amps at 150 Vdc. As well as 60 or 80 amps at 300Vdc.

All MidNite circuit breakers can be used at 100% rated current when mounted in a MidNite enclosure.
All MidNite circuit breakers hold 100% rated current independent of ambient temperature.

Contact your dealer or visit www.midnitesolar.com for more information.

Breaker and Busbar Torque Values

Torque battery disconnect breaker to 15 Ft-Lbs (20.4NM)

Torque panel mount breakers to 30 In-Lbs (3.4NM)

MNBE-8D2x2 Instructions (continued)

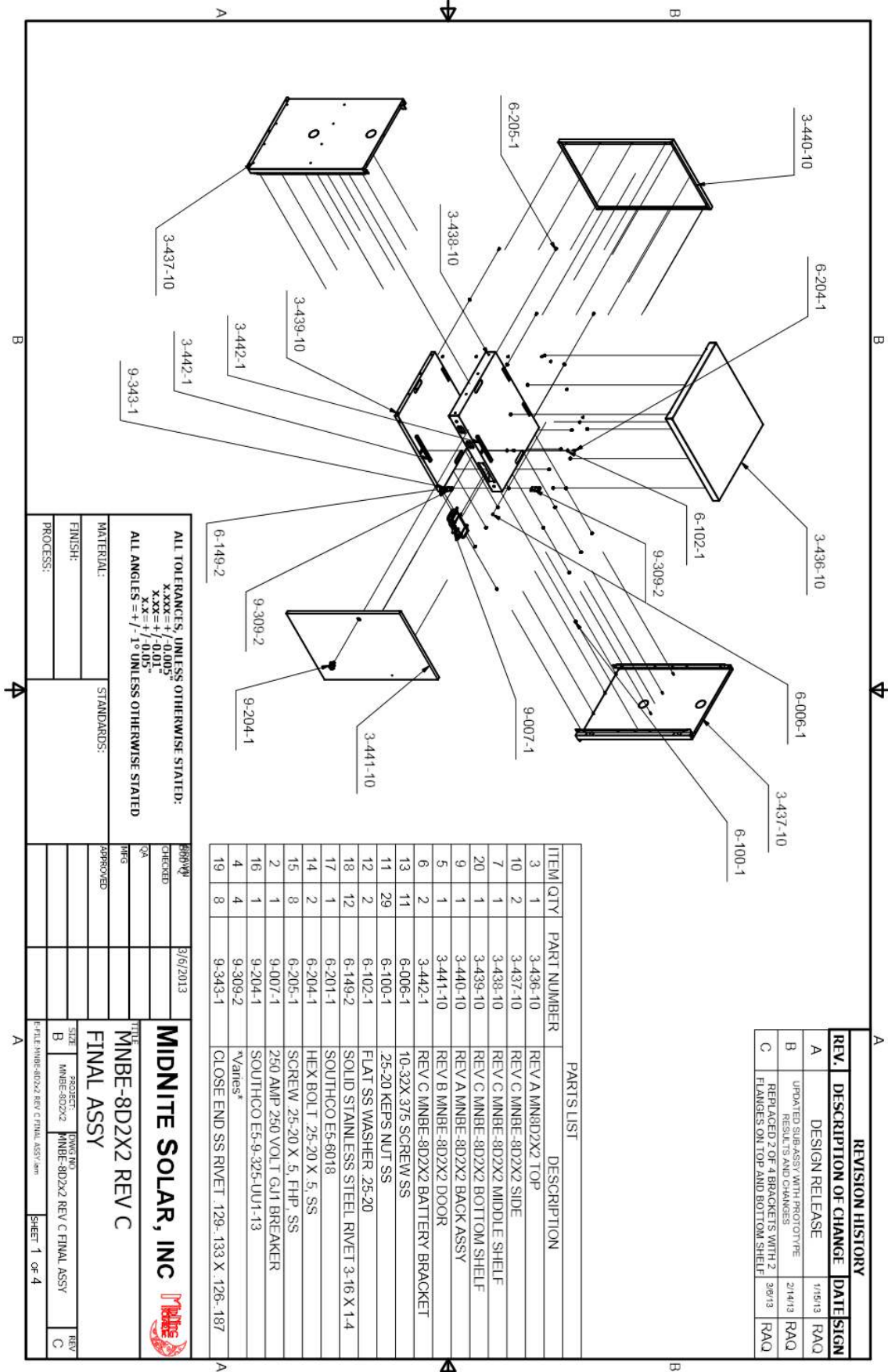

REVISION HISTORY			
REV.	DESCRIPTION OF CHANGE	DATE	SIGN
A	DESIGN RELEASE	1/15/13	RAQ
B	UPDATED SUB-ASSY WITH PROTOTYPE RESULTS AND CHANGES	2/14/13	RAQ
C	REPLACED 2 OF 4 BRACKETS WITH 2 FLANGES ON TOP AND BOTTOM SHELF	3/6/13	RAQ

PARTS LIST		
ITEM QTY	PART NUMBER	DESCRIPTION
3	3-436-10	REV A MNBE-8D2X2 TOP
10	3-437-10	REV C MNBE-8D2X2 SIDE
7	3-438-10	REV C MNBE-8D2X2 MIDDLE SHELF
20	3-439-10	REV C MNBE-8D2X2 BOTTOM SHELF
9	3-440-10	REV A MNBE-8D2X2 BACK ASSY
5	3-441-10	REV B MNBE-8D2X2 DOOR
6	3-442-1	REV C MNBE-8D2X2 BATTERY BRACKET
13	6-006-1	10-32X.375 SCREW SS
11	6-100-1	25-20 KEPS NUT SS
12	6-102-1	FLAT SS WASHER 25-20
18	6-149-2	SOLID STAINLESS STEEL RIVET 3-16 X 1-4
17	6-201-1	SOUTHCO ES-6018
14	6-204-1	HEX BOLT 25-20 X 5, SS
15	6-205-1	SCREW 25-20 X 5, FHP, SS
2	9-007-1	250 AMP 250 VOLT G.U.I BREAKER
16	9-204-1	SOUTHCO ES-9-325-U01-13
4	9-309-2	*Varies*
19	9-343-1	CLOSE END SS RIVET .129-.133 X .126-.187

ALL TOLERANCES, UNLESS OTHERWISE STATED:
 XXXX = + / -0.005"
 XXX = + / -0.01"
 XX = + / -0.015"
 X = + / -0.03"
ALL ANGLES = +/- 1° UNLESS OTHERWISE STATED

STANDARDS:
 APPROVED: _____
 FINISH: _____
 PROCESS: _____

MIDNITE SOLAR, INC

FINAL ASSY
 TITLE: MNBE-8D2X2 REV C
 DATE: 3/6/2013
 CHECKED: _____
 QA: _____
 DESIGNED: _____
 APPROVED: _____

SHEET 1 OF 4
 FILE: MNBE-8D2X2 REV C FINAL ASSY.dwg

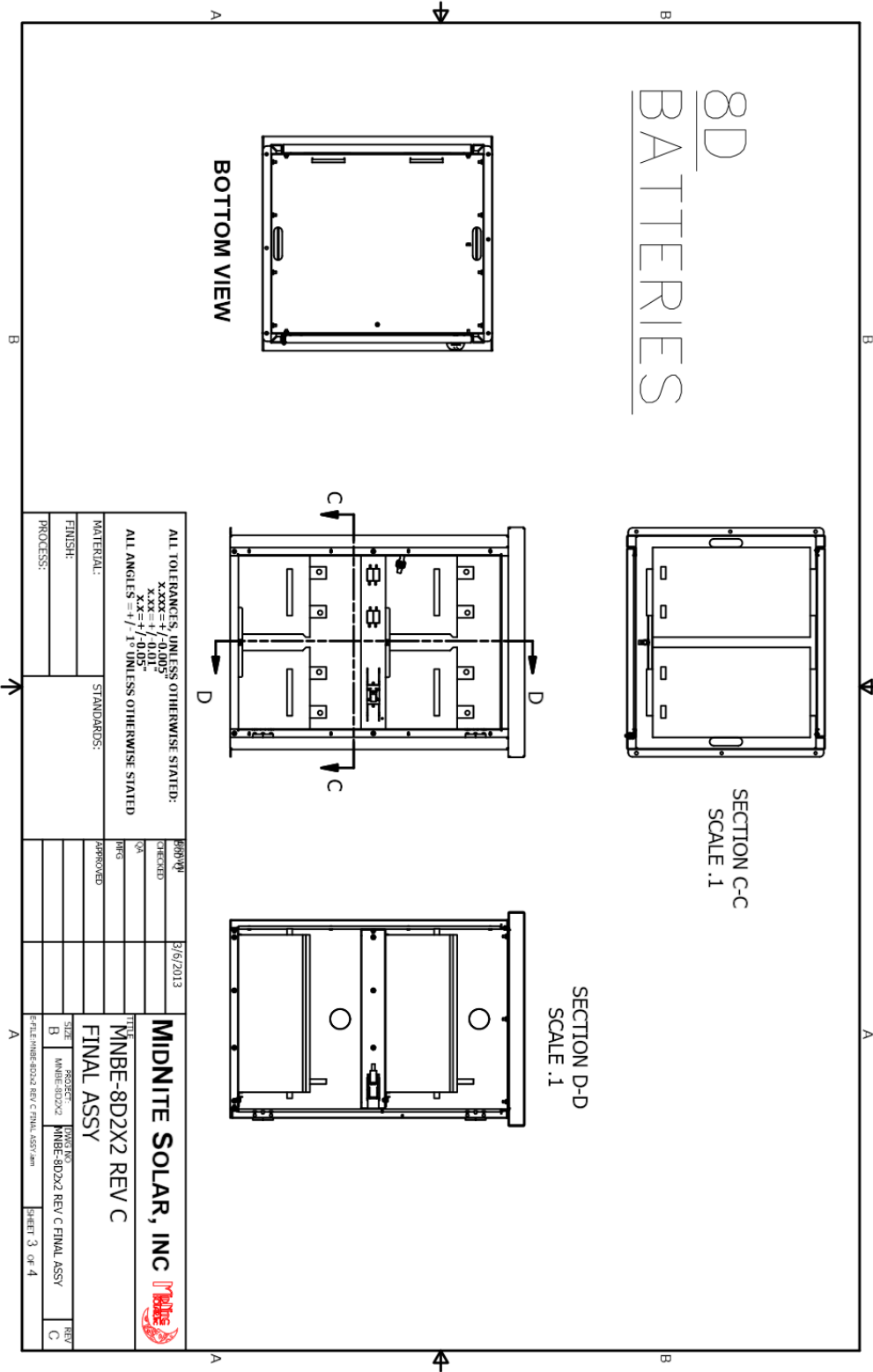

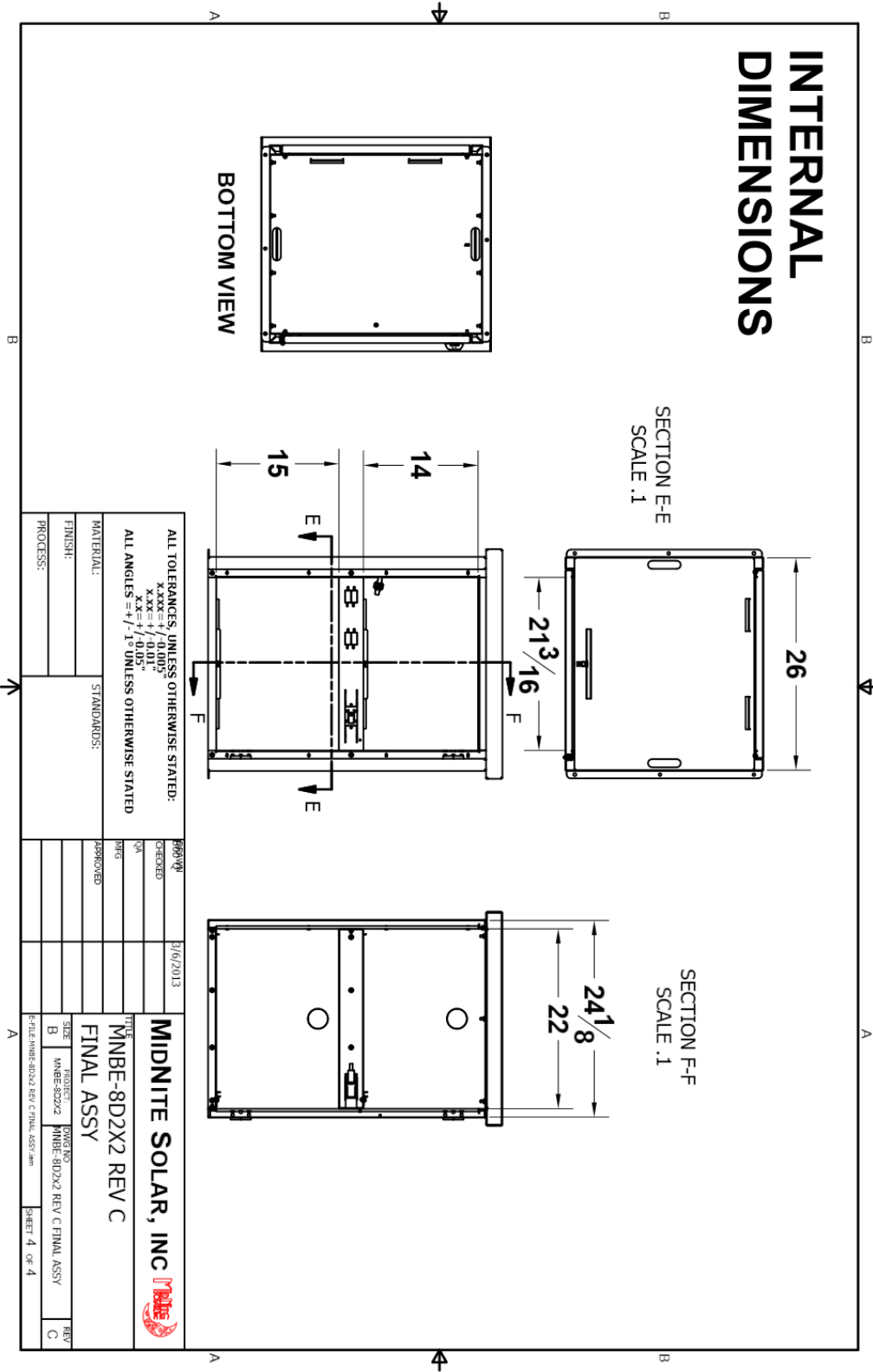

MIDNITE SOLAR INC. LIMITED WARRANTY
MidNite Solar Power electronics, sheet metal enclosures and accessories

MidNite Solar Inc. warrants to the original customer that its products shall be free from defects in materials and workmanship. This warranty will be valid for a period of five (5) years for all products except the MNKID Charge Controller which will be two (2) years.

At its option, MidNite Solar will repair or replace at no charge any MidNite product that proves to be defective within such warranty period. This warranty shall not apply if the MidNite Solar product has been damaged by unreasonable use, accident, negligence, service or modification by anyone other than MidNite Solar, or by any other causes unrelated to materials and workmanship. The original consumer purchaser must retain original purchase receipt for proof of purchase as a condition precedent to warranty coverage. To receive in-warranty service, the defective product must be received no later than two (2) weeks after the end of the warranty period. The product must be accompanied by proof of purchase and Return Authorization (RA) number issued by MidNite Solar. For an RMA number contact MidNite Solar Inc., 17722 67th Ave NE, Arlington, WA 98223 (360) 403-7207.

Purchasers must prepay all delivery costs or shipping charges to return any defective MidNite Solar product under this warranty policy. Except for the warranty that the products are made in accordance with, the specifications therefore supplied or agreed to by customer:

MIDNITE SOLAR MAKES NO WARRANTY EXPRESSED OR IMPLIED, AND ANY IMPLIED WARRANTY OF MERCHANTABILITY OR FITNESS FOR A PARTICULAR PURPOSE WHICH EXCEEDS THE FOREGOING WARRANTY IS HEREBY DISCLAIMED BY MIDNITE SOLAR AND EXCLUDED FROM ANY AGREEMENT MADE BY ACCEPTANCE OF ANY ORDER PURSUANT TO THIS QUOTATION. MIDNITE SOLAR WILL NOT BE LIABLE FOR ANY CONSEQUENTIAL DAMAGES, LOSS OR EXPENSE ARISING IN CONNECTION WITH THE USE OF OR THE INABILITY TO USE ITS GOODS FOR ANY PURPOSE WHATSOEVER. MIDNITE SOLAR'S MAXIMUM LIABILITY SHALL NOT IN ANY CASE EXCEED THE CONTRACT PRICE FOR THE GOODS CLAIMED TO BE DEFECTIVE OR UNSUITABLE.

Products will be considered accepted by customer unless written notice to the contrary is given to MidNite Solar within ten (10) days of such delivery to customer. MIDNITE SOLAR is not responsible for loss or damage to products owned by customer and located on MIDNITE SOLAR'S premises caused by fire or other casualties beyond MIDNITE SOLAR'S control. This warranty is in lieu of all other warranties expressed or implied.

MIDNITE SOLAR INC. 17722 67TH AVE NE ARLINGTON, WA 98223

Email:

info@midnitesolar.com

PH: 360-403-7207 FAX: 360-691-6862