



CAUTION: Equipment Damage

These procedures should be done by a qualified installer who is trained on programming inverter power systems. Failure to set accurate parameters for the system could potentially cause equipment damage. Damage caused by inaccurate programming is not covered by the limited warranty for the system.



IMPORTANT

Check the firmware revision of all OutBack devices before use. The Radian inverter and MATE3 system display may not communicate or operate correctly unless their firmware is above a specified revision number.
 For model GS7048E, the firmware must be revision 001.005.xxx or higher with a MATE3 revision of 002.010.xxx or higher.
 For model GS3548E, the firmware must be revision 001.005.xxx or higher with a MATE3 revision of 002.017.xxx or higher.



WARNING: Fire/Explosion Hazard

Do not place combustible or flammable materials within 3.7 m (12 feet) of the equipment. This unit employs mechanical relays and is not ignition-protected. Fumes or spills from flammable materials could be ignited by sparks.



WARNING: Personal Injury

Use safe lifting techniques and standard safety equipment when working with this equipment.



IMPORTANT:

Clearance and access requirements may vary by location. Maintaining a 90-cm (36") clear space in front of the system for access is recommended.
 Consult local electric code to confirm clearance and access requirements for the specific location.

The MATE3 Configuration Wizard allows quick setup of parameters that apply to all systems. The Configuration Wizard is reached from the MATE3 Main Menu as shown to the right.

The firmware revision of all devices can be confirmed by navigating from the MATE3 Main Menu as shown below. Upgrades to the firmware revision can be downloaded from the OutBack website www.outbackpower.com.

Firmware Revision

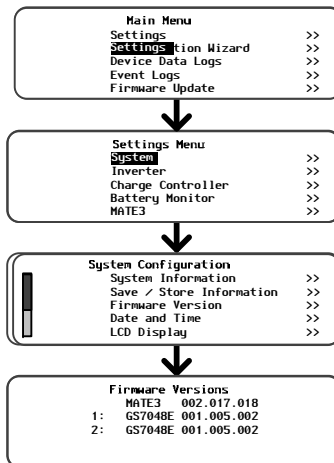

Configuration Wizard

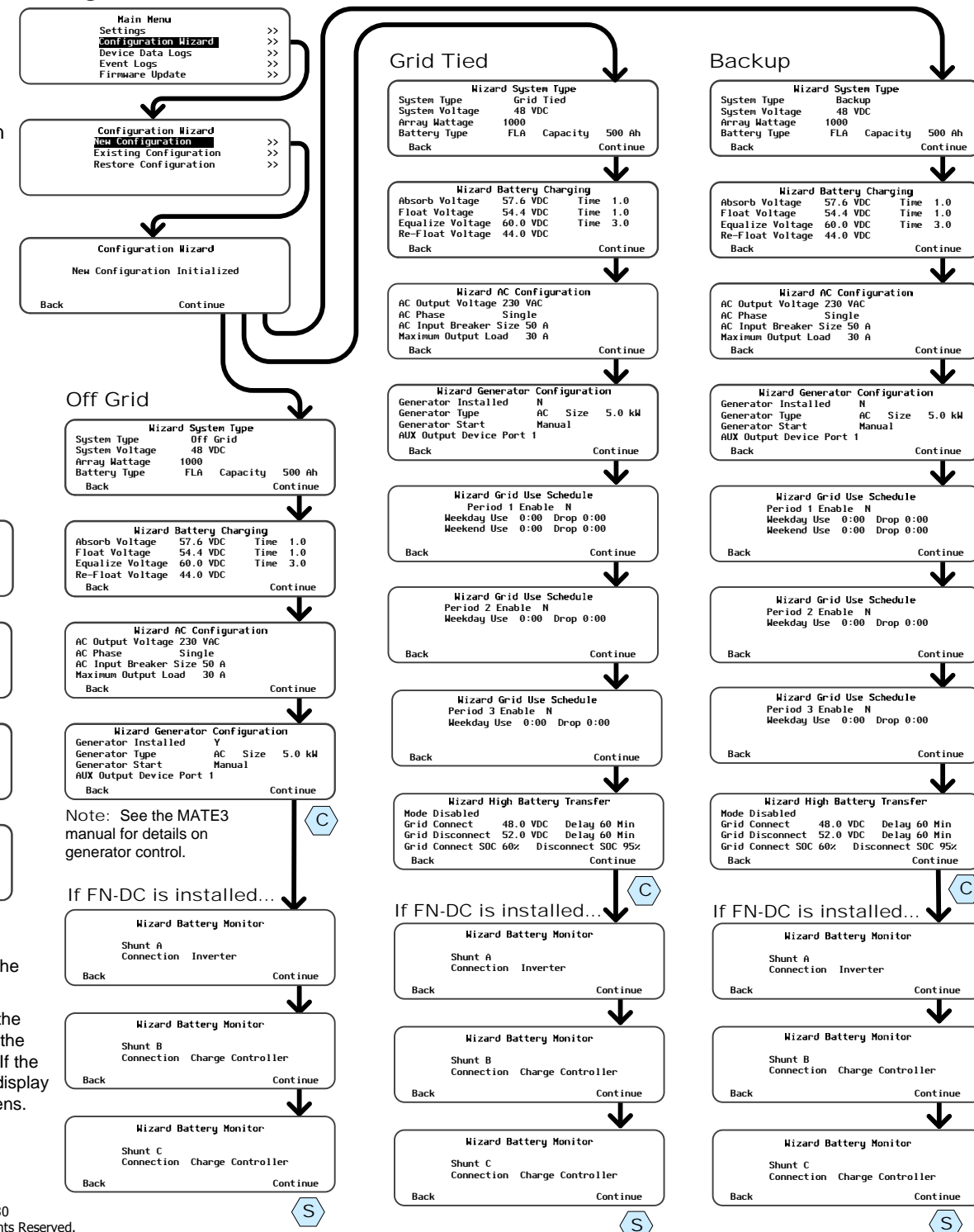

- S** This advances the display to the Setup Complete screen.
- C** This advances the display to the Setup Complete screen if the FLEXnet DC is not installed. If the FLEXnet DC is installed, the display advances to the Shunt screens.

Radian Inverter/Charger

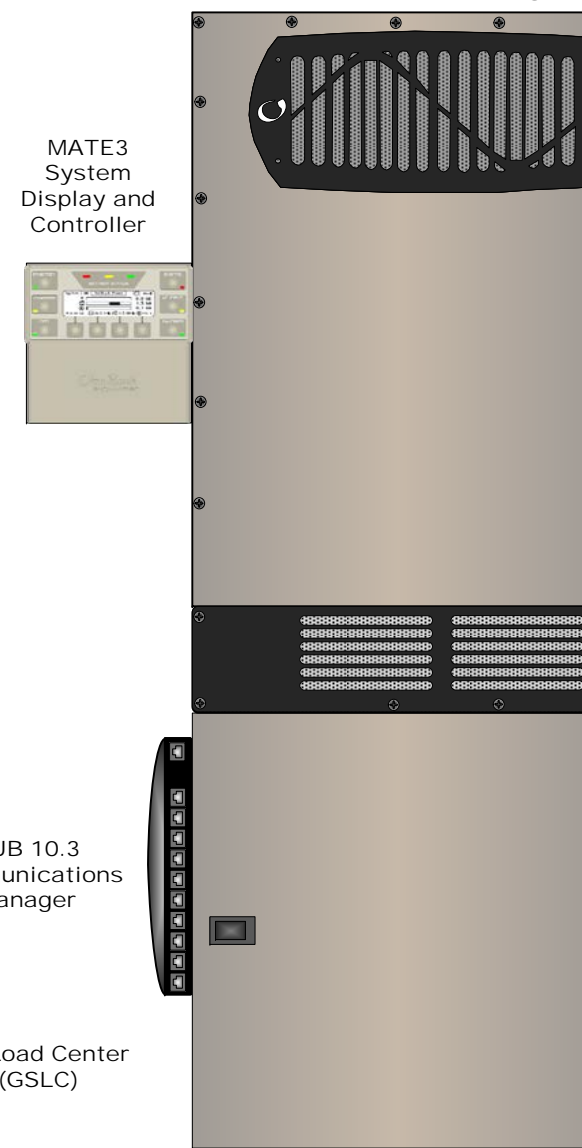

HUB 10.3 Communications Manager

GS Load Center (GSLC)

FM80 Charge Controllers (x2)



Major Components	
Radian System Products	
Inverter/Charger	GS7048E GS3548E
GS Load Center	GSLC175-PV-230 GSLC175PV1-230 (both depicted)
System Display and Controller	MATE3 depicted (with FW-MB3 mounting bracket)

Optional OutBack Components	
Communications Manager	HUB10.3 depicted
Charge Controller	FLEXmax 80 depicted (with FW-CCB2 mounting bracket)
PV Combiner Box	PV12 depicted
Remote Temperature Sensor (RTS)	
FLEXnet DC Monitor (FN-DC)	
Battery Bank	EnergyCell depicted

Customer-Supplied Components	
AC Source	Utility Grid or AC Generator
Main Electrical Panel (or overcurrent device for the AC source)	
Electrical Distribution Subpanel (Load Panel)	
Photovoltaic (PV) Array	

IMPORTANT:
Not intended for use with life support equipment.



Masters of the Off-Grid.™
First Choice for the New Grid.

Contact Technical Support:
 Telephone: +1.360.618.4363
 Email: Support@outbackpower.com
 Website: www.outbackpower.com

- Ensure the mounting surface is strong enough to handle 3 times the total weight of all the components. Add plywood or other reinforcing material as necessary to strengthen the surface.
- Attach the wall bracket. Center the mounting holes on the wall studs. Use all 6 mounting screws to secure the bracket.
- Lift the inverter so that the inverter bracket is above the wall bracket.
- Lower the inverter so that the inverter bracket slips into the wall bracket.
- If GSLC is not used: Secure the inverter to the surface using a minimum of 1 wall screw (or appropriate hardware).
- If GSLC is used: Unscrew the inverter bottom screws approximately (0.6 cm (1/4") to 0.5 cm (3/16")).
- Align the GSLC along the bottom of the inverter. Slide the bottom screws into the keyhole slots.
- Mark the spots for the GSLC mounting feet. (If necessary, remove the GSLC to install wall anchors.) Install screws to secure the feet.
- Follow the appropriate instructions for installing other components. Different mounting locations are available.

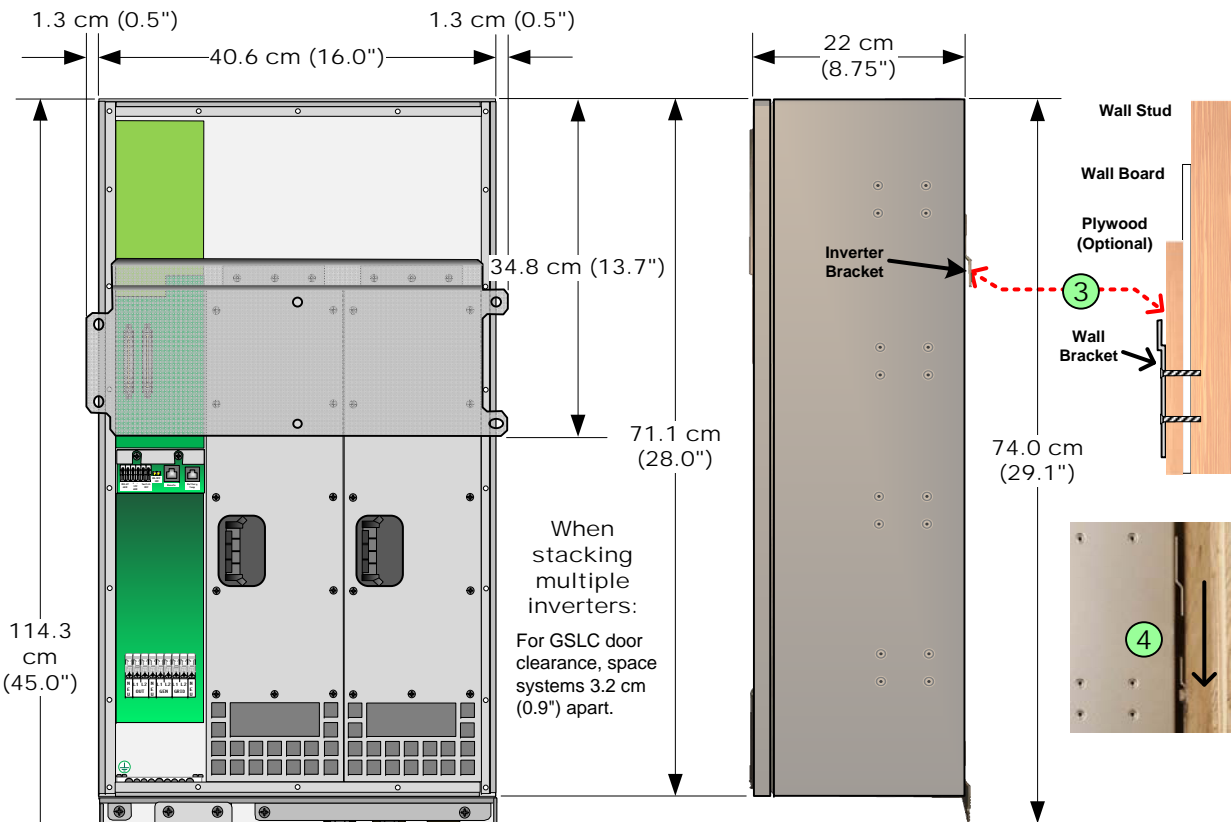
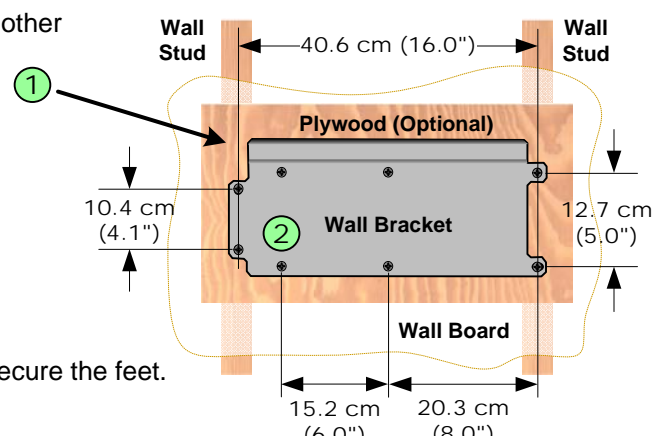

When stacking multiple inverters:
For GSLC door clearance, space systems 3.2 cm (0.9") apart.

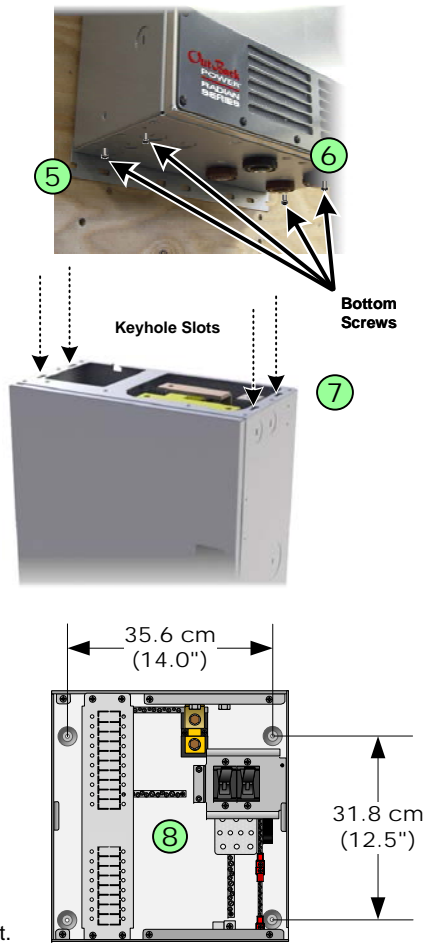

AC Wire Sizes and Torque Values

Wire Size	Torque		
mm ²	AWG	Nm	In-lb
2.5 to 6	#14 to #10	2.3	20
10	#8	2.8	25
16 to 25	#6 to #4	4.0	35
35	#3	4.0	35
35	#2	4.5	40
50	#1	5.6	50
70	1/0	5.6	50

OutBack recommends that conductors be 16 mm² copper, or larger, rated to 75°C (minimum) unless local code requires otherwise.

Minimum DC Cable based on the DC Circuit Breaker

Circuit Breaker	Cable Size	Torque	
		Nm	In-lb
60	#6 AWG (16 mm ²)	4.0	35
80	#4 AWG (25 mm ²)	4.0	35
125	1/0 (70 mm ²)	5.6	50
175	2/0 (70 mm ²)	25.4	225
250	4/0 (120 mm ²)	25.4	225

Torque Requirements

Circuit Breaker Stud	Torque		DC Plates	Torque	
	Nm	In-lb		Nm	In-lb
M8	2.3	20	Upper holes (+)	6.8	60
1/4 - 20	4.0	35	Lower holes (+)	5.6	50
5/16 - 18	5.6	50	Shunt Bolts (-) and GS-SBUS	6.8	60
3/8 - 16	25.4	225			

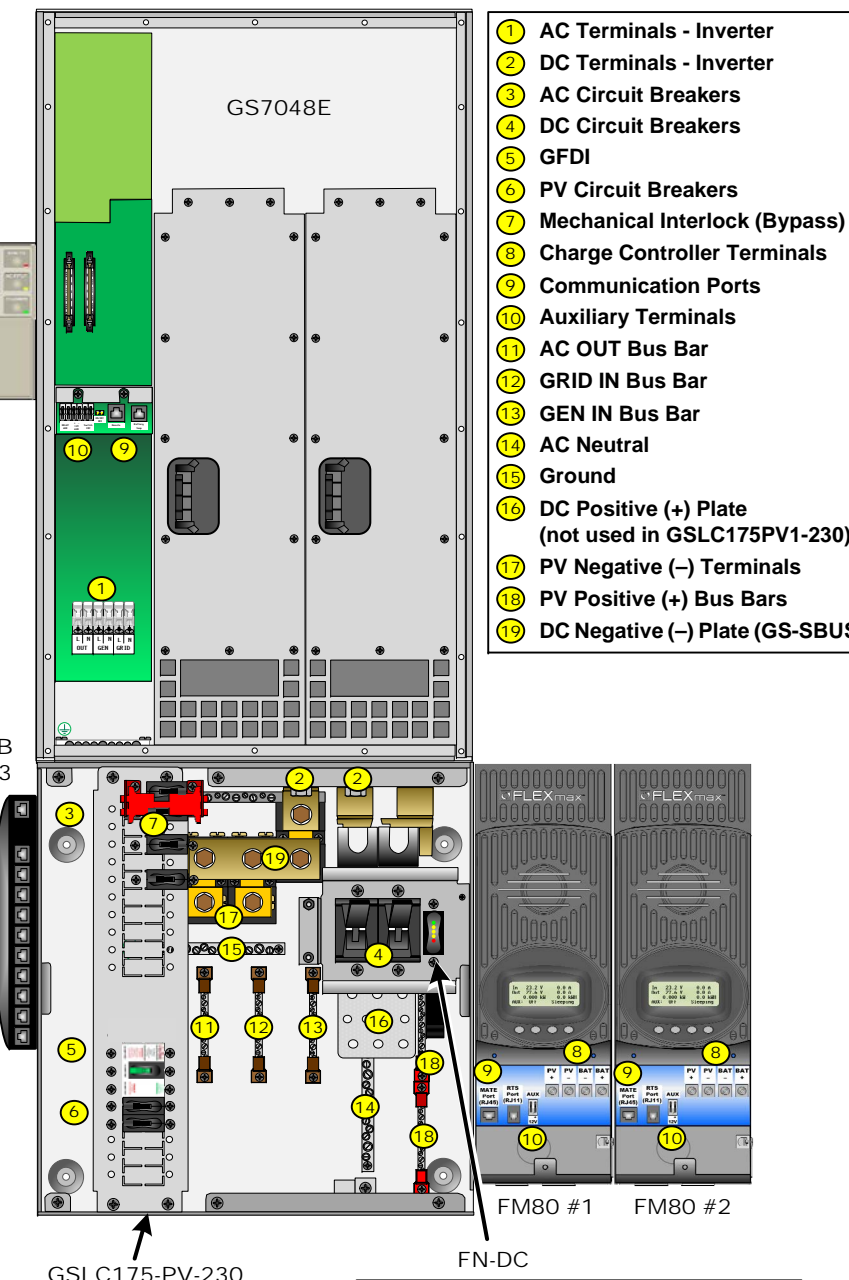

- AC Terminals - Inverter
- DC Terminals - Inverter
- AC Circuit Breakers
- DC Circuit Breakers
- GFDI
- PV Circuit Breakers
- Mechanical Interlock (Bypass)
- Charge Controller Terminals
- Communication Ports
- Auxiliary Terminals
- AC OUT Bus Bar
- GRID IN Bus Bar
- GEN IN Bus Bar
- AC Neutral
- Ground
- DC Positive (+) Plate (not used in GSLC175PV1-230)
- PV Negative (-) Terminals
- PV Positive (+) Bus Bars
- DC Negative (-) Plate (GS-SBUS)

Left Side:
The Radian allows two locations for the MATE3 mounting bracket (FW-MB3).

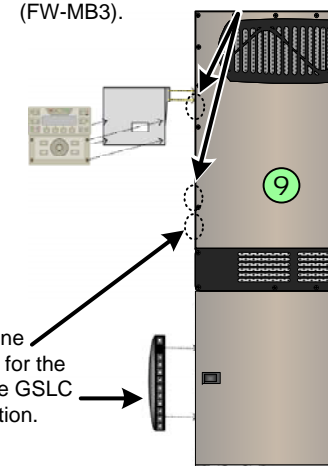

The Radian has one mounting location for the HUB product. The GSLC also has one location.

Right Side:
The FLEXmax charge controller is mounted with the FW-CCB bracket. The FW-CCB2 allows two controllers side by side (using the forward holes to allow for conduit.)

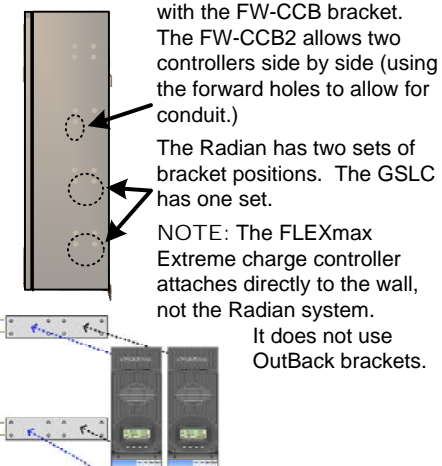

The Radian has two sets of bracket positions. The GSLC has one set.
NOTE: The FLEXmax Extreme charge controller attaches directly to the wall, not the Radian system.
It does not use OutBack brackets.

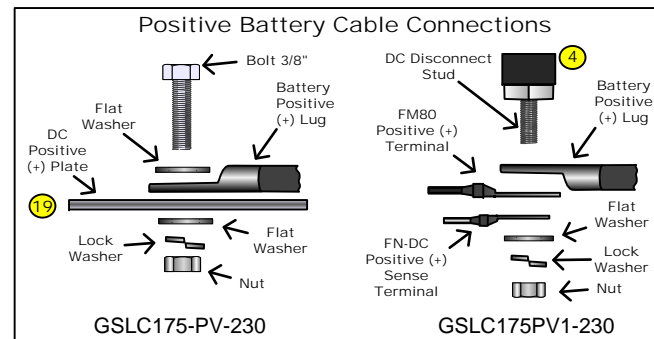

CAUTION: Equipment Damage
When connecting cables from the Radian inverter to the battery terminals, make sure to observe the proper polarity. Connecting the cables incorrectly can damage or destroy the equipment and void the product warranty.

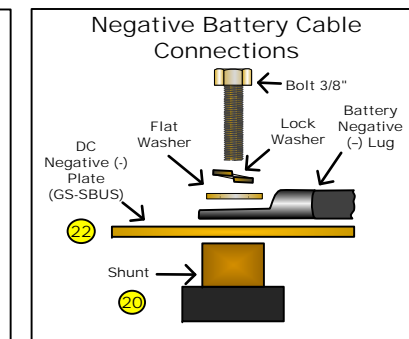

FN-DC LED Indicators

Color	Battery State of Charge
Green	> 90% (blinks if charge parameters are met)
Yellow	≥ 80%
Yellow	≥ 70%
Yellow	≥ 60%
Red	≥ 60% off, < 60% solid, < 50% blinks

FN-DC wiring is displayed on the Wiring page.

Wiring to AC terminals is displayed on the Wiring page.

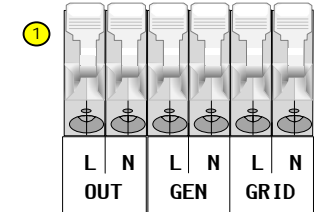

CAUTION: Fire Hazard
 Before energizing, confirm that all hardware is installed as shown on the Installation page. Stacking battery terminal hardware in any other order can overheat the terminals.

Pre-startup Procedures:

1. Double-check all wiring connections.
2. Inspect the enclosure to ensure no debris or tools have been left inside.
3. Disconnect all AC loads at the backup (or critical) load panel.
4. Disconnect the AC input feed to the GSLC at the source.

To energize or start the OutBack devices:

1. Using a digital voltmeter (DVM), verify 48 Vdc on the DC input terminals by placing the DVM leads on (1a) and (1b).

Confirm that the battery voltage is correct for the inverter and charge controller models.

Confirm the polarity.

CAUTION: Equipment Damage
 Incorrect polarity will damage the equipment.

2. Turn on (close) the GFDI circuit breaker. **1**
3. Verify that the PV input for each charge controller is in the correct range of open-circuit voltage and confirm the polarity by:
 - a) placing the DVM leads on (2a) and (1b), and
 - b) placing the DVM leads on (2b) and (1b).
4. Turn on (close) the PV input circuit breakers. **2**
5. Turn on (close) the DC circuit breakers from the battery bank to the inverter. **3**
6. If the inverter is in the Off state, turn it On. **4**
8. Turn on (close) the AC Output circuit breakers. **5**
7. Verify 230 Vac on the AC Output TBB by placing the DVM leads on (4) and (3).
8. Start the generator if appropriate. Verify 230 Vac on the terminals of the AC input sources.
10. Turn on the AC Input to the GSLC at the source.
11. Verify 230 Vac on the GRID IN TBB by placing the DVM leads on (5) and (3).
12. Verify 230 Vac on the GEN IN TBB by placing the DVM leads on (6) and (3).
13. Turn on (close) the AC input circuit breakers. **6**
14. Turn on the AC disconnects at the backup (or critical) load panel and test the loads.

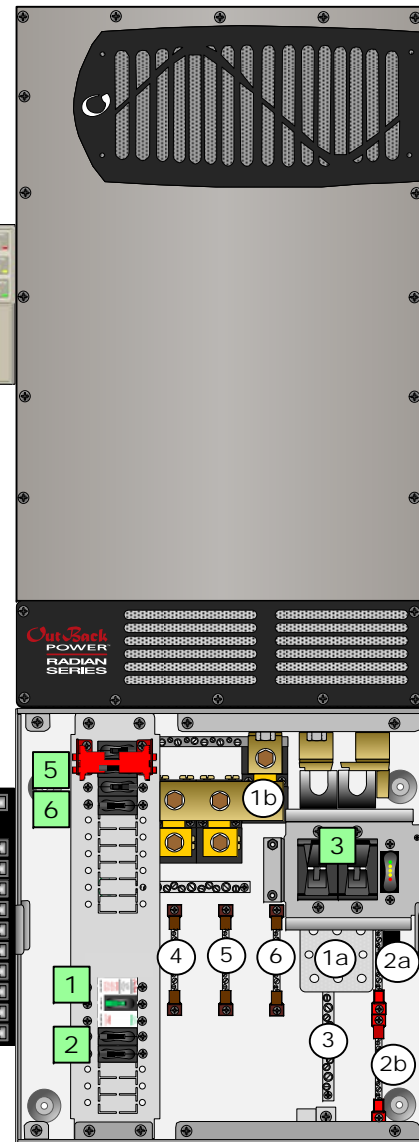

Functional Test Points			
Battery Voltage Test Points			
(1a)	(1b)	(1c)	(1d)
PV Voltage Test Points			
(2a)	(2b)	(2c)	(2d) (1b)
AC OUT Voltage Test Points (Terminal bus bar = TBB)			
(3)	(4)		
GRID IN Voltage Test Points (Terminal bus bar = TBB)			
(3)	(5)		
GEN IN Voltage Test Points (Terminal bus bar = TBB)			
(3)	(6)		

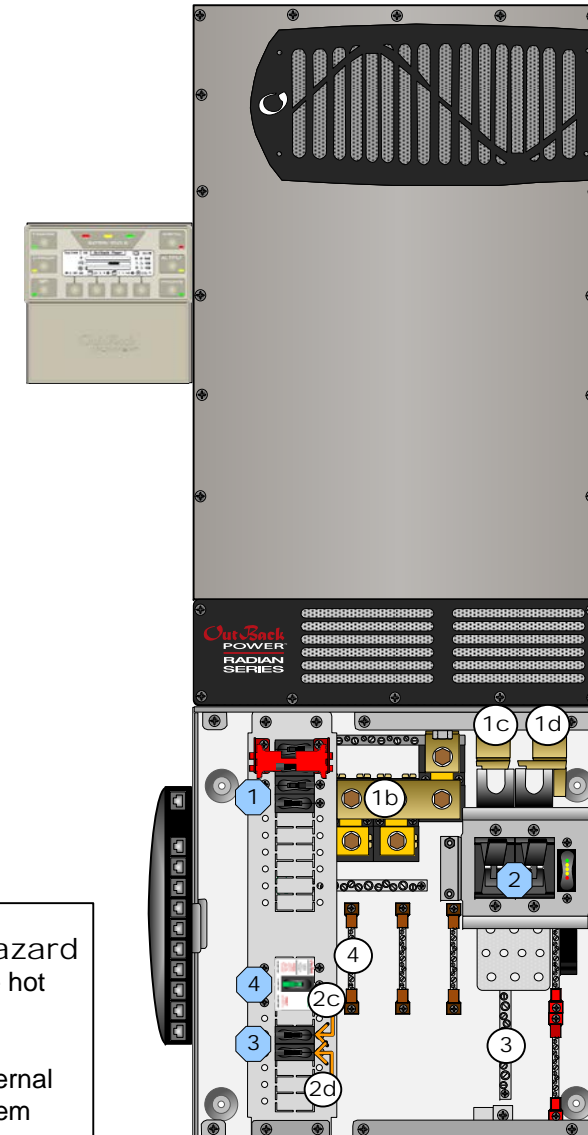

Functional Test Points			
Battery Voltage Test Points			
(1a)	(1b)	(1c)	(1d)
PV Voltage Test Points			
(2a)	(2b)	(2c)	(2d) (1b)
AC OUT Voltage Test Points (Terminal bus bar = TBB)			
(3)	(4)		

Test points 2c and 2d refer to the right terminal of each circuit breaker.

WARNING: Burn Hazard
 Internal parts can become hot during operation. Do not remove the cover during operation or touch any internal parts. Be sure to allow them sufficient time to cool down before attempting to perform any maintenance.

WARNING: Lethal Voltage
 Review the system configuration to identify all possible sources of energy. Ensure ALL sources of power are disconnected before performing any installation or maintenance on this equipment. Confirm that the terminals are de-energized using a validated voltmeter (rated for a minimum 1000 Vac and 1000 Vdc) to verify the de-energized condition.

WARNING: Lethal Voltage
 The numbered steps will remove power from the inverter and charge controllers. However, sources of energy may still be present inside the GSLC and other locations. To ensure absolute safety, disconnect ALL power connections at the source.

To de-energize or shut down the OutBack devices:

1. Turn off (open) the AC circuit breakers. **1**
2. Turn off (open) the DC circuit breakers for the battery. **2**
 Wait 5 minutes for the devices to internally discharge themselves.
3. Turn off (open) the PV circuit breakers. **3**
4. Turn off (open) the GFDI circuit breaker. **4**
5. Verify 0 Vdc on the first DC bus of the inverter by placing the voltmeter leads on (1b) and (1c).
6. Verify 0 Vdc on the second DC bus by placing the voltmeter leads on (1b) and (1d).
7. Verify 0 Vdc on one PV circuit by placing the voltmeter leads on (2c) and (1b).
8. Verify 0 Vdc on the other PV circuit by placing the voltmeter leads on (2d) and (1b).
9. Verify 0 Vac on the AC output circuit breakers by placing the voltmeter leads on (4) and (3).

