

Quick Hook® SS & LS

Standard and Low Height Hooks for Side Mount Rails



Installation Instructions

Quick Mount PV®
RESPECT THE ROOF

Quick Hook® SS & LS

Instructions for Installing Standard and Low Height Hooks for Side Mount Rails

Installation Tools Required: stud finder, tape measure, utility knife, drill with 7/32" bit, impact drill with 1/2" socket, #3 phillips power bit (use with drill only), caulking gun, appropriate sealant compatible with roofing materials, roofing bar, hand broom, electric grinder with a 4.5" triple sandwich tuck point blade.



Remove the tile at selected location of the mount. Locate and mark the center of the rafter.



Rest the base plate over center of rafter and mark center of holes. Drill two 7/32" pilot holes and fill with sealant compatible with roofing materials.



Connect hook to base plate and drive lag screws into rafter through the two holes to a solid, snug fit. DO NOT over tighten lag screws, this may compromise their holding strength.

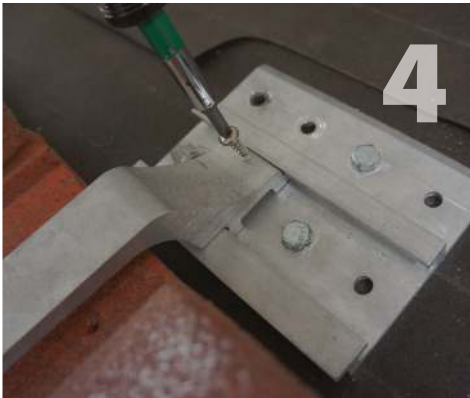

Slide hook into desired position within valley of the tile. Hook must not overhang the sides of the base plate. Drive self-tapping screw using a #3 Phillips bit on a screw driver or drill with clutch set at a medium torque, to secure hook to base. **Do not use impact gun on screw.**



Carefully clean the underlayment then apply bead of sealant compatible with roofing materials in the shape of an upside down U on the backside of the sub-flashing, and install flashing over mount. Fasten sub-flashing to deck with one roofing nail in each top corner. Do not nail bottom corners.



Waterproof at underlayment level according to roofing manufacturer instructions and Tile Roofing Institute Guidelines.



Cut a clearance notch in the weather guard lug using a grinder with a tuck point blade. Make sure the tile seats back down in its original position. Leave at least 1/4" of tile to prevent breaking through.



Bolt the side-mounted rail of your choice to the hook, using the rail manufacturer's hardware.

Follow all the directions of the rack manufacturer as well as the module manufacturer.

All roofing manufacturers' written instructions must also be followed by anyone modifying a roof system. Please consult the roof manufacturer's specs and instructions prior to touching the roof.

Additional tips and information for installing tile hooks:

- To speed installation, prep the tile hook arm by partially seating the self tapping screw into the arm before getting onto the roof.
- See Quick Hook install and Quick Tips videos on tile cutting, installing wood blocks, and more at: www.quickmountpv.com/support/videos.html
- For more details on waterproofing please visit our website: <http://www.quickmountpv.com/tile-waterproofing>
- Take care not to damage tiles while working on the roof. When walking on the roof place your foot where tiles overlap. For more information on the proper way to walk on a tile roof visit the Tile Roofing Institute's website: <http://tileroofing.org/>
- If you cannot find replacements for broken tiles of the same color, painting the replacement tiles to match is recommended. If the tile being replaced is in a highly visible section of the roof consider swapping the tile with one from a section of the roof that is not visible. Tile adhesive should be used only to repair small breaks and chips like broken corners. Completely broken or cracked tiles will not fit properly if repair with tile adhesive is attempted.
- When shims are used under the Quick Hook Base Plate the following is recommended:
 - Screw embedment must be checked for proper holding force
 - Flashing must still have the necessary coverage
 - Shim material must be compatible with aluminum and roofing materials
 - Consulting with a Structural Engineer is recommended

WARNING: Quick Mount PV products are NOT designed and should NOT be used for anchoring fall protection equipment.

BOTH SIDES OF SLOT SERRATED

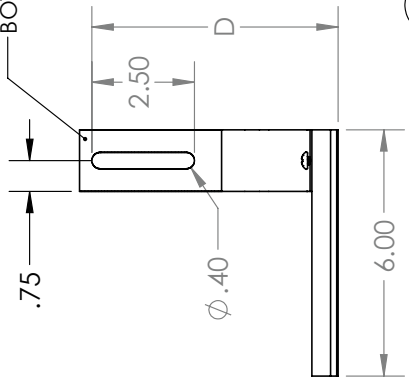

DIMENSION	QMHS	QMHLs
A	6.57	6.30
B	2.21	1.93
C	1.89	1.60
D	6.27	6.00

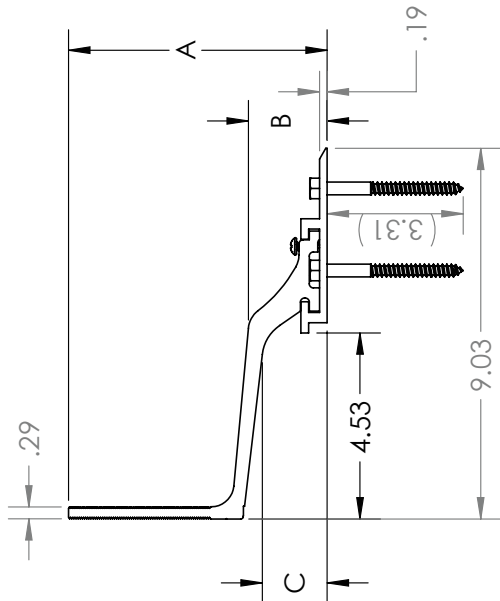

#3 TYPE 1 (PHILLIPS) DRIVE ON SCREW 1

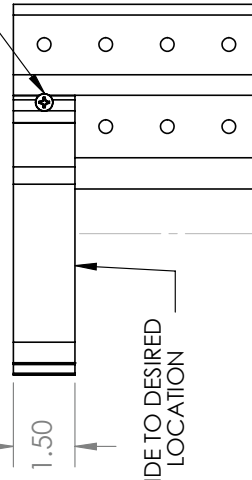

IDENTIFYING MARK ON QMHLs ONLY

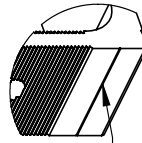

DETAIL E
SCALE 1 : 2

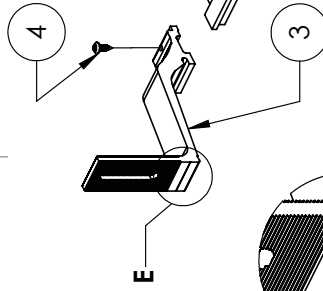

1 DO NOT USE IMPACT DRILL ON SCREW

ITEM NO.	DESCRIPTION	QTY.
1	BASE PLATE, QUICK HOOK, 6", 6061-T6, MILL	1
2	LAG SCREW, HEX HEAD, 5/16" x 3-1/2", 18-8SS	2
3	QUICK HOOK, STANDARD/LOW HEIGHT, VERTICAL, 1.5", 6061-T6/6005A-T61, MILL	1
4	SCREW, SELF-TAPPING, #12 X 5/8", 18-8SS, MILL	1
5	SUBFLASHING, QUICK HOOK, 6" BASE, 9" X 14" X .032", 3003-O, MILL	1

PROPRIETARY AND CONFIDENTIAL
THE INFORMATION CONTAINED IN THIS DRAWING IS THE SOLE PROPERTY OF QUICK MOUNT PV. ANY REPRODUCTION IN PART OR AS A WHOLE WITHOUT THE WRITTEN PERMISSION OF QUICK MOUNT PV IS PROHIBITED.

DO NOT SCALE DRAWING

Quick Mount PV®

TITLE:
QMHS & QMHLs: QUICK HOOK FOR SIDE MOUNTED RAILS

UNLESS OTHERWISE SPECIFIED: DIMENSIONS ARE IN INCHES FRACTIONAL ± 1/8 TWO PLACE DECIMAL ± .18 THREE PLACE DECIMAL ± .125	SIZE A	DRAWN BY: RAD	REV 10
SCALE: 1:8	DATE: 1/8/2016	WEIGHT: 1.82	SHEET 1 OF 2

2 1

3 4 5

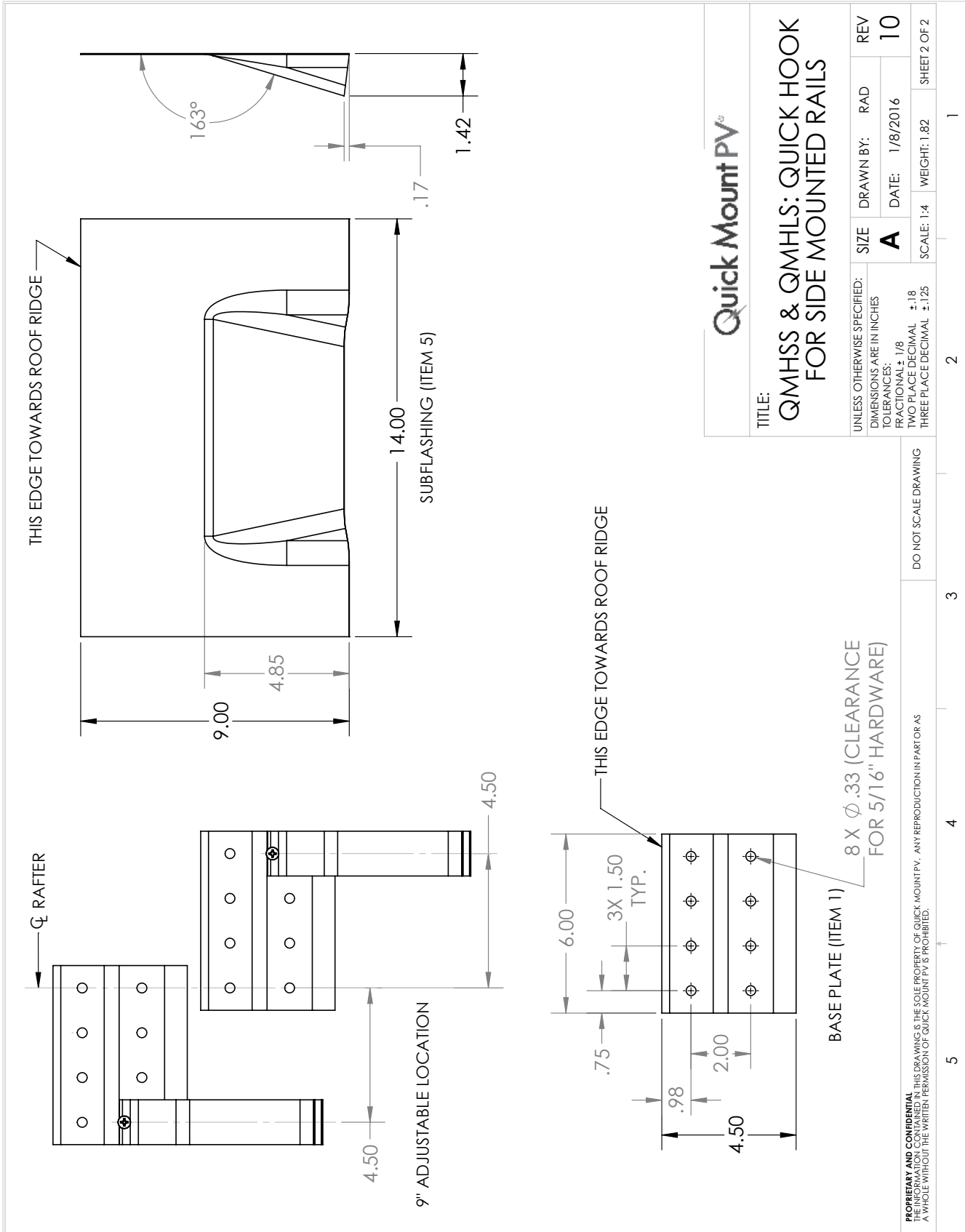

Quick Mount PV[®]

TITLE:
**QMHS & QMHS: QUICK HOOK
 FOR SIDE MOUNTED RAILS**

UNLESS OTHERWISE SPECIFIED: DIMENSIONS ARE IN INCHES	SIZE	DRAWN BY:	REV
TOLERANCES: FRACTIONAL $\pm 1/8$	A	DATE: 1/8/2016	10
TWO PLACE DECIMAL $\pm .18$	SCALE: 1:4	WEIGHT: 1.82	SHEET 2 OF 2
THREE PLACE DECIMAL $\pm .125$			

DO NOT SCALE DRAWING

PROPRIETARY AND CONFIDENTIAL
 THE INFORMATION CONTAINED IN THIS DRAWING IS THE SOLE PROPERTY OF QUICK MOUNT PV. ANY REPRODUCTION IN PART OR AS
 A WHOLE WITHOUT THE WRITTEN PERMISSION OF QUICK MOUNT PV IS PROHIBITED.

1 2 3 4 5



925-478-8269 • www.quickmountpv.com • tech@quickmountpv.com
2700 Mitchell Dr., Bldg. 2 • Walnut Creek, CA 94598