

SOLAR'S MOST TRUSTED

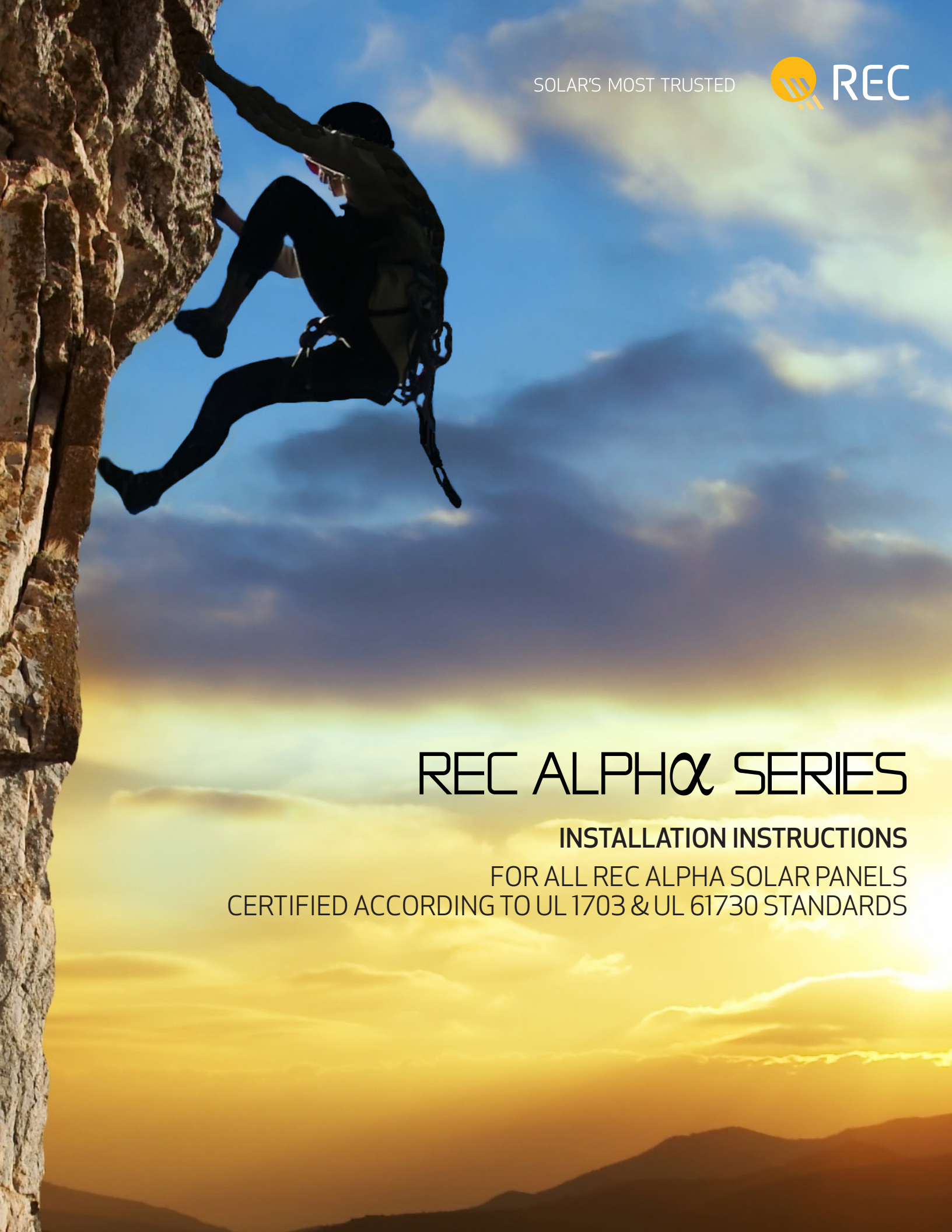

# REC ALPHA SERIES

**INSTALLATION INSTRUCTIONS**

FOR ALL REC ALPHA SOLAR PANELS  
CERTIFIED ACCORDING TO UL 1703 & UL 61730 STANDARDS

# CONTENTS

<b>CONTENTS</b>	<b>2</b>
List of figures	2
<b>INTRODUCTION</b>	<b>3</b>
How to use this manual	3
Your responsibility as an installer	3
Support	3
Liability disclaimer	3
Limited warranty	3
<b>SAFETY MEASURES</b>	<b>4</b>
Safety in the working area	4
Panel handling	4
<b>ELECTRICAL INSTALLATION</b>	<b>5</b>
<b>MECHANICAL INSTALLATION</b>	<b>5</b>
Fire guidelines	5
Orientation	5
Environmental factors	5
<b>PANEL INSTALLATION</b>	<b>6</b>
Rail specifications	6
Clamp specifications	6
Mounting methods: Clamping with rails parallel to the short side	7
Mounting methods: Clamping with rails parallel to the long side	8
Mounting methods: Slide in systems	9
Mounting methods: Mounting holes	9
Drainage holes	10
Grounding	10
<b>CONNECTIONS AND CONNECTORS</b>	<b>11</b>
<b>MAINTENANCE</b>	<b>12</b>
Cleaning instructions	12
Recycling	12
Disposal of old electrical and electronic equipment	12
<b>PANEL CHARACTERISTICS</b>	<b>13</b>
Technical Properties: REC Alpha Series	13
Technical Properties: REC Alpha Black Series	14
<b>ANNEX 1: INSTALLATIONS ON WATER PLATFORMS</b>	<b>15</b>
<b>ANNEX 2: INSTALLATIONS USING RAPID SHUTDOWN DEVICES</b>	<b>16</b>
<b>DOCUMENT HISTORY</b>	<b>17</b>

## LIST OF FIGURES

Fig. 1: Clamp specifications: End and mid-clamps	6	Fig. 8: Mounting hole installation example: REC Alpha	9
Fig. 2: Clamping of panels with rails parallel to the short side	7	Fig. 9: Drainage and grounding holes	10
Fig. 3: Clamping zones for panels with rails parallel to short side	7	Fig. 10: Grounding lug dimensions and fastening torque	10
Fig. 4: Clamping of panels with rails parallel to the long side	8	Fig. 11: Minimum cable bend radius	11
Fig. 5: Clamping zones for panels with rails parallel to long side	8	Fig. 12: Panel dimensions: REC Alpha Series	13
Fig. 6: Mounting holes: REC Alpha	9	Fig. 13: Panel dimensions: REC Alpha Black Series	14
Fig. 7: Mounting hole specifications: REC Alpha	9	Fig. 14: RSD device installation zones	16

# INTRODUCTION

Thank you for choosing REC photovoltaic panels for your installation. REC Alpha solar panels are ideal for delivering long-lasting and reliable power output. They have been created through intelligent design and are manufactured to the highest quality and environmental standards. With correct installation and maintenance, REC panels will provide clean, renewable energy for many years.

Please read this entire manual carefully. It contains critical information on safety, as well as detailed instructions for the installation, operation and maintenance of the panels. Failure to follow these procedures will invalidate the warranty (available to download via [www.recgroup.com/warranty](http://www.recgroup.com/warranty)). Review all instructions and safety notes before working on the system. Failure to do so may lead to injury or damage to property.

## HOW TO USE THIS MANUAL

This installation manual describes the procedures for the terrestrial mounting in a photovoltaic array of all REC Alpha Series solar panels of a '60-cell size' certified according to UL 1703 & UL 61730 standards. This includes all product variants (as indicated by the use of the appropriate suffix in the panel name) with a white or black backsheet, and a silver or black frame. The installed panel is considered to be in compliance with UL 1703 & UL 61730 only when mounted in the manner specified by this installation manual. Note that any panel without a frame (laminated) is not considered to comply with the requirements of UL 1703 & UL 61730 unless mechanically installed with hardware that has been tested and evaluated with the panel under this standard or by a field inspection certifying that the installed panel complies with the requirements of UL 1703 & UL 61730.

Except where specifically stated, the information and drawings within this manual refer to all frame, backsheet, and cell types; the illustrations are meant to be a generic representation of the instructions detailed in the text regardless of the color or exact design depicted. Review this entire manual before commencing installation of the panels and ensure you are working from the latest version. Throughout the manual, you will see icons which highlight important information or notes:

 **Indicates potential for damage to the array, property or personal safety.**

 **Indicates important notes on best practice to help with the installation.**

For further information on installation procedures, please call your panel distributor or contact your local REC Solar office. Details can be found at: [www.recgroup.com/contact](http://www.recgroup.com/contact).

## YOUR RESPONSIBILITY AS AN INSTALLER

Installers are responsible for the safe and effective installation and operation of the photovoltaic system and for adhering to all applicable local and national standards and regulations. Prior to installation, check all current regulations and permits concerning solar installations and ensure all local directives are observed. Furthermore, installers are responsible for the following points:

- Ensuring the REC panels are in a suitable condition for use and appropriate for the particular installation and environment,
- Using only parts that comply with the specifications set out in this manual,
- Ensuring a safe installation of all aspects of the electrical array.

 **All equipment should be properly maintained and inspected prior to use.**

 **As this installation manual may contain installation instructions for a number of different product variants, ensure you follow the instructions given for the correct product where specified.**

## SUPPORT

Do not attempt to install REC solar panels when you are unsure of the procedure or suitability. For questions or guidance with your installation, please call your distributor or contact your REC sales office, which can be found at: [www.recgroup.com/contacts](http://www.recgroup.com/contacts).

## LIABILITY DISCLAIMER

REC SOLAR PTE. LTD. accepts no liability for the usability and functionality of its photovoltaic panels if the instructions in this guide are not observed. Since compliance with this guide and the conditions and methods of installation, operation, use and maintenance of the panels are not checked or monitored by REC SOLAR PTE. LTD., REC SOLAR PTE. LTD. accepts no liability for damage arising from improper application or incorrect installation, operation or maintenance. This does not apply to damages due to a panel fault, in cases of loss of life, bodily injury or damage to health or in the event of a grossly negligent breach of obligations on the part of REC SOLAR PTE. LTD. and/or in the event of an intentional or grossly negligent breach of obligations by a legal representative or vicarious agent. REC reserves the right to make changes or amendments to this manual at any time, without prior notice.

This document may be produced in different languages. If there is any conflict, the English language version shall be definitive.

## LIMITED WARRANTY

The REC Limited Warranty is available to download from [www.recgroup.com/warranty](http://www.recgroup.com/warranty). Ignoring any of the instructions in this manual may be classed as improper installation or use and invalidate the Warranty Terms and Conditions. If you have any questions about installation and the Warranty validity, please contact REC's technical support.

 **Caution: Only qualified personnel should perform work on photovoltaic systems such as installation, commissioning, maintenance and repairs. Be sure to follow the safety instructions for all system components. Ensure relevant local codes and regulations for health and safety are observed.**

# SAFETY MEASURES

Installers are responsible for the safe and effective installation and operation of the system and for adhering to all applicable local and national standards and regulations. All relevant local codes and regulations should be referred to and observed as well as regulations on working at heights and fall protection.

## SAFETY IN THE WORKING AREA

### i) Safety in the working area

Installation of REC solar panels may involve working on rooftops or raised platforms. Ensure all local regulations regarding working at heights are followed. Before beginning work on a photovoltaic system, ensure all working surfaces are structurally sound and capable of bearing the weight of employees and required equipment.

 **Remember to isolate the system from the grid before carrying out any maintenance or repair work.**

### ii) Preventing current generation

To prevent the panels automatically generating current (electricity) when exposed to light, shield the system with a non-transparent cover during installation, maintenance or repair work.

### iii) Specific hazards of DC electricity

Solar panels generate direct current (DC). Once current is flowing, breaking or opening a connection (e.g., disconnecting two panels) can cause an electrical arc. Unlike low voltage AC wiring, DC arcs are not self-extinguishing; they are potentially lethal burn and fire hazards, capable of high temperatures that can destroy contacts and connectors:

- Follow inverter manufacturers' installation, handling and operating instructions,
- Remove/open the inverter AC fuse/circuit breaker before disconnecting from the public grid,
- Switch off or disconnect the inverter and wait for the time specified by the manufacturer before commencing work. High-voltage components need sufficient time to discharge.

### iv) Safety requirements

The voltage produced by a single panel, and panels connected in series (voltages added together) or in parallel (currents added together), can be dangerous. Although the fully insulated plug contacts on the panel's output cables provide touch-safe protection, the following points must be observed during handling to avoid the risk of sparking, fire hazards, burns and lethal electric shocks:

- Exercise extreme caution when wiring panels and look out for damaged or dirty cables etc,
- Never insert metallic or other conductive objects into plugs or sockets,
- Ensure that all electrical connections are completely dry before assembly,
- Keep all materials, tools, and working conditions dry and tidy,
- Use appropriate safety equipment e.g., non-slip footwear, insulated gloves and insulated tools,
- Solar panels produce current when exposed to sunlight. Do not connect the system to the inverter during solar exposure.

## PANEL HANDLING

In order to avoid damage to the solar cells and other components, all REC solar panels should be handled with care and protected from damage at all times. All warnings and instructions on the packaging should be observed. Follow these guidelines when unpacking, transporting, carrying, installing or storing panels:

- Record the serial numbers prior to installation and note the information in the system documentation,
- Carry the panels using both hands and do not use the junction box or cables as a grip,
- Do not allow the panels to sag or bow under their own weight when being carried,
- Do not subject panels to loads or stresses, e.g., leaning on them or through the placing of weight on them,
- Do not stand or walk on the panels,
- Avoid dropping the panels as any damage caused may be unseen,
- Keep all electrical contacts clean and dry,
- Do not apply force to the backsheets,
- Avoid using sharp or pointed objects if panels require marking,
- Never apply paints, adhesives or detergents to the front or rear of the panel,
- Do not use any solar panel that is damaged or has been tampered with,
- Never attempt to disassemble, modify, or adapt the panels or labels in any way as this will void the warranty.

 **Use clean and protective gloves when handling the panel as this will avoid the transfer of any fingerprints or soiling to the highly-sensitive and anti-reflective glass surface, ensuring improved light transmission and avoiding any contamination.**

 **The pallet packaging is not water- or weatherproof. Prior to installation, and to avoid any damage or degradation to the packaging or panel components, pallets and panels must be stored in a controlled and protected environment, ideally in internal storage conditions, where it is shielded from the elements, e.g., rain, dust, and direct sunlight. If overnight external storage in an uncontrolled environment is unavoidable, the panels and the pallet packaging must be protected from direct exposure to the elements and from contact with the ground, including earth, mud etc.**

 **Do not use a panel which is broken or damaged. If the panel front glass is broken or laminate back sheet is damaged, it can expose personnel to hazardous voltages.**



# ELECTRICAL INSTALLATION

## ELECTRICAL REQUIREMENTS

### i) System Requirements

REC solar panels are only for use where they meet the specific technical requirements of the complete system. Ensure other components will not cause mechanical or electrical damage to the panels. Only panels of the same type and power class should be connected.

### ii) String configuration

When using string configuration, plan and execute it according to the inverter manufacturer's instructions. The number of panels connected to an inverter must be within the inverter voltage limits and operating range. Do not exceed the total system voltage permitted by the manufacturer, nor under any circumstance exceed the maximum system voltage as stated in the technical specifications for the product at the rear of this manual. The maximum system fuse rating and the maximum reverse current for each panel can be found in the technical specifications for the product at the rear of this manual.

### iii) String connection

If panels are connected in series, they must have the same ampere rating. If panels are connected in parallel, they must have the same voltage rating. The maximum number of panels that can be connected in series or parallel depends upon system design, type of inverter and environmental conditions. Panel and string configuration must correspond to the specifications of other system components e.g., inverter. Refer to the reverse current rating of the panel as indicated in the technical characteristics section to the rear of this manual or on the panel datasheet.

### iv) Wiring

Wiring installation shall be in accordance with the National Electric Code (NEC) (or CSA C22.1, Safety Standard for Electrical Installations, Canadian Electrical Code, Part 1 where applicable). To minimize voltage surges (e.g., indirect lightning strikes), cables of the same string must be bundled together so loops are as small as possible. String configurations must be checked before commissioning. If open circuit voltage ( $V_{oc}$ ) and short circuit current ( $I_{sc}$ ) deviate from specification, this may indicate a configuration fault. Correct DC polarity must be observed at all times.

### v) Electrical Ratings

Electrical ratings are within a specific tolerance of measured values at Standard Test Conditions (STC) as given in the technical characteristics for each panel at the rear of this manual. Under normal conditions, a photovoltaic panel is likely to experience conditions that produce more current and/or voltage than reported at STC. The requirements of the NEC in Article 690 must be followed to address these increased outputs. In installations not under the requirements of the NEC, the values of  $I_{sc}$  and  $V_{oc}$  marked on the panels must be multiplied by a factor of 1.25 (or according to local regulations) when determining component voltage ratings, conductor ampacities, overcurrent device ratings and size of controls connected to the PV output.

# MECHANICAL INSTALLATION

## FIRE GUIDELINES

REC Alpha panels have a Type 2 fire rating according to UL1703. The fire performance rating of the panels is only valid when mounted in the manner specified in this installation manual. The complete system fire class rating is to be achieved by the combination of panel fire performance type and UL2703 certified mounting structure for a non-BIPV panel. Please refer to mounting structure UL2703 listing for System Fire Classification. Any specific limitations on the inclination or accessories required to maintain a specific System Fire Class Rating must be clearly specified in the mounting system manufacturer's installation instructions and UL2703 certification. Utilize the following fire safety guidelines when installing REC panels:

- Check with all relevant local authorities for fire safety requirements for any building or structure on to which the panels will be installed,
- The system design must ensure that it can be easily accessed in the event of a building fire,
- Check with relevant authorities for applicable regulations concerning setbacks or other placement restrictions that may apply for roof-mounted arrays,
- The use of DC ground fault interrupters is recommended. This may also be required by local and national codes,
- All electrical appliances are a fire risk. The panel must be mounted over a fire retardant roof covering rated for the application and a distance of at least 2.4 in (60 mm) between the panel and the mounting surface, to allow the free circulation of air beneath the panels at all times.

## ORIENTATION

The optimal mounting position of panels results in the sun's rays falling perpendicular (i.e., at 90°) to the surface. To maximize system output, panels should be installed at the optimum orientation and tilt angle. The specifics of this depend on location and can be calculated by a qualified system designer. All panels in a string should, wherever possible, have the same orientation and tilt to ensure the system does not underperform due to mismatched outputs.

 **The solar panels must not be exposed to artificially concentrated light.**

## ENVIRONMENTAL FACTORS

REC solar panels are designed to provide decades of durable and stable output in installations up to 6500 ft (2000 m) above sea level. Ambient operating temperatures must be between -40° - 185°F (-40° and +85°C).

 **For further information regarding installations on water platforms, e.g., floating pontoons, see Annex 1 at the rear of this manual.**

The panels are not suitable for installation in potentially hazardous locations nor should they be installed in the following locations:

- Near sources of flammable gas or vapor e.g., gas stations, gas containers or spray paint facilities,
- Near open flames,
- Under water or in water features,
- Where exposed to sulfur e.g., near sulfur springs or volcanoes,
- Where the panels may be exposed to harmful chemicals.

 **Ensure panels are not exposed to direct contact with salt water/spray.**

# PANEL INSTALLATION

REC solar panels are designed for capturing solar radiation and are not suitable for use as overhead or vertical glazing. The IP rating of the junction box provides a level of protection that allows panels to be mounted in any orientation (see product technical specifications for exact rating). The panels are considered to be in compliance with UL 1703 & UL 61730, only when the panel is mounted according to the mounting instructions specified below:

**! Panels must be installed so that the cells are not shaded as this will drastically reduce electrical output. If partial shading is inevitable at certain times of the day or year, it must be kept to an absolute minimum.**

There are different options for securing REC solar panels depending on the design of the array. Ensure the mounting structure can withstand anticipated wind and snow loads. Mounting hardware is not supplied by REC. Follow the mounting hardware manufacturer's instructions and recommendations at all times.

**! Common hardware items such as nuts, bolts, star washers, lock washers and the like have not been evaluated for electrical conductivity or for use as grounding devices and should be used only for maintaining mechanical connections and holding electrical grounding devices in the proper position for electrical conductivity. Such devices, where supplied with the panel and evaluated through the requirements in UL 1703 & UL 61730, may be used for grounding connections in accordance with the instructions provided with the panel.**

**! Remove any labels or stickers that may be on the front of the panels and ensure no residue is left on the glass.**

**! There must be a minimum clearance gap of 2.4 in (60 mm) between the uppermost part of the installation surface (e.g., rooftop) and the lowest part of the panel (i.e., underside of panel frame) to avoid any damage to the panel and to ensure sufficient airflow for cooling, helping to improve performance. The surface below the panels must be kept clear of any objects that may cause damage to the panel.**

## RAIL SPECIFICATIONS

REC solar panels are typically installed on a rail-based mounting system. Rails must be suitable for the intended installation and able to withstand anticipated snow and wind loads. When using mounting rails, ensure they run underneath the panel to provide support to the frame. The positioning of the rail must ensure that the minimum clamp grip length and the central point of the fixation, e.g., the bolt, is fully within the required clamping zone as indicated on the following pages.

## CLAMP SPECIFICATIONS

REC panels have been evaluated to UL 1703 & UL 61730 standards for mounting using rails in combination with end and mid clamps. Ensure the clamps used are rigid and suitable for the planned installation and expected system design loads.

- Minimum grip length of 1.6 in (40 mm); a grip depth of 0.2 - 0.4 in (5 - 10 mm) (fig. 1). The grip area must not extend onto the panel glass and/or cause cell shading.
- Each panel must be clamped at a minimum of four points, in each quarter of the panel, as illustrated on the subsequent pages,
- Clamp installation must be carried out according to the manufacturer's instructions, including specific hardware and torque requirements,
- Avoid the application of excessive pressure to prevent frame deformation.

Fig. 1: Clamp specifications: End and mid-clamps

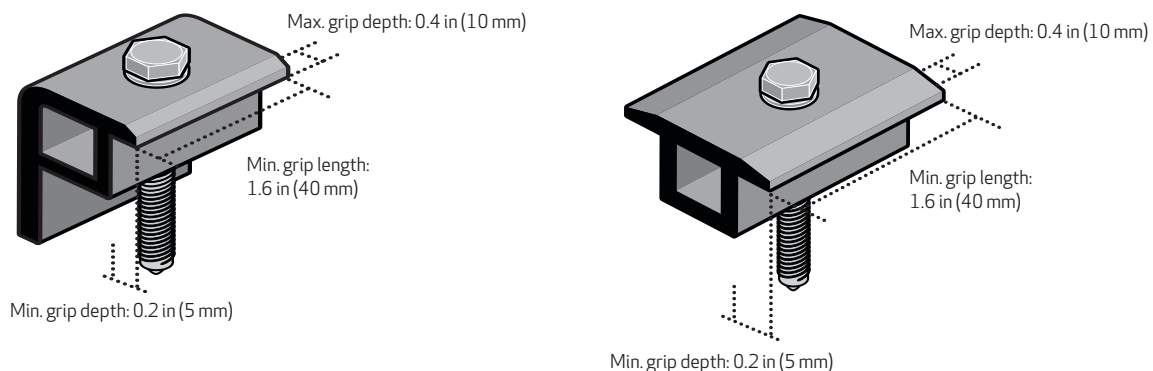

**! In areas of snow build-up panels can be subjected to forces in excess of the stated limit even when snow depth does not appear extreme, causing damage to the framework. If the installation is likely to be affected by this, further suitable panel support is recommended, especially on the lower row of panels.**

**★ In the case of any questions regarding mounting systems, or if the mounting system to be used does not match any of the instructions shown in this installation manual, please contact REC for further support.**

## MOUNTING METHODS: CLAMPING WITH RAILS PARALLEL TO THE SHORT SIDE

REC Alpha solar panels secured by clamping to mounting rails has been found to comply with UL 1703 & UL 61730 requirements for downward pressure, e.g., snow, of up to 146 psf (7000 Pa or 4666 Pa design load\*) and upward pressure, e.g., wind, of up to 55.6 psf (4000 Pa or 2666 Pa design load\*) according to the instructions below (\*design loads apply a safety factor of 1.5 to the stated test load, e.g., test load 7000 Pa / 1.5 = 4666 Pa design load). Site-specific factors such as high winds or snow levels must be taken into consideration to ensure this limit is not exceeded. These instructions must be followed for each clamping method used:

- Clamps must be positioned so that both the minimum grip length and the center point of each clamp are located in the required clamping zone,
- Follow the clamp manufacturer's instructions to install the clamps, including the recommended applied torque,
- The distance between the end clamp and the end of the rail must be a minimum of 1 in (25 mm).

When clamping to a rail-based construction, the rails must run underneath the panel to provide support to the frame. Where the rails are positioned parallel to the short side of the panel as per the examples shown in fig. 2, the clamping zones shown in fig. 3 are to be followed. The positioning of the rails must ensure that the minimum grip length of the clamp and the central point of the fixation, e.g., the bolt, is fully within the required clamping zone as indicated in fig. 3:

**!** Each panel must be clamped in a minimum of four separate zones, with one clamping point in each quarter of the panel (fig. 3).

Fig. 2: Clamping of panels with rails parallel to the short side

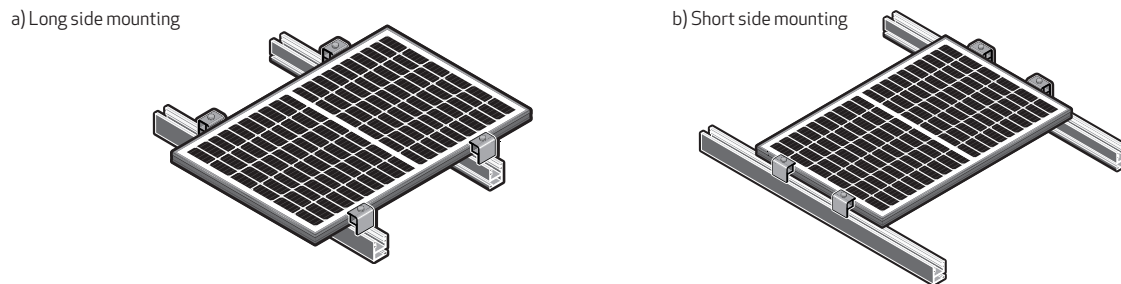
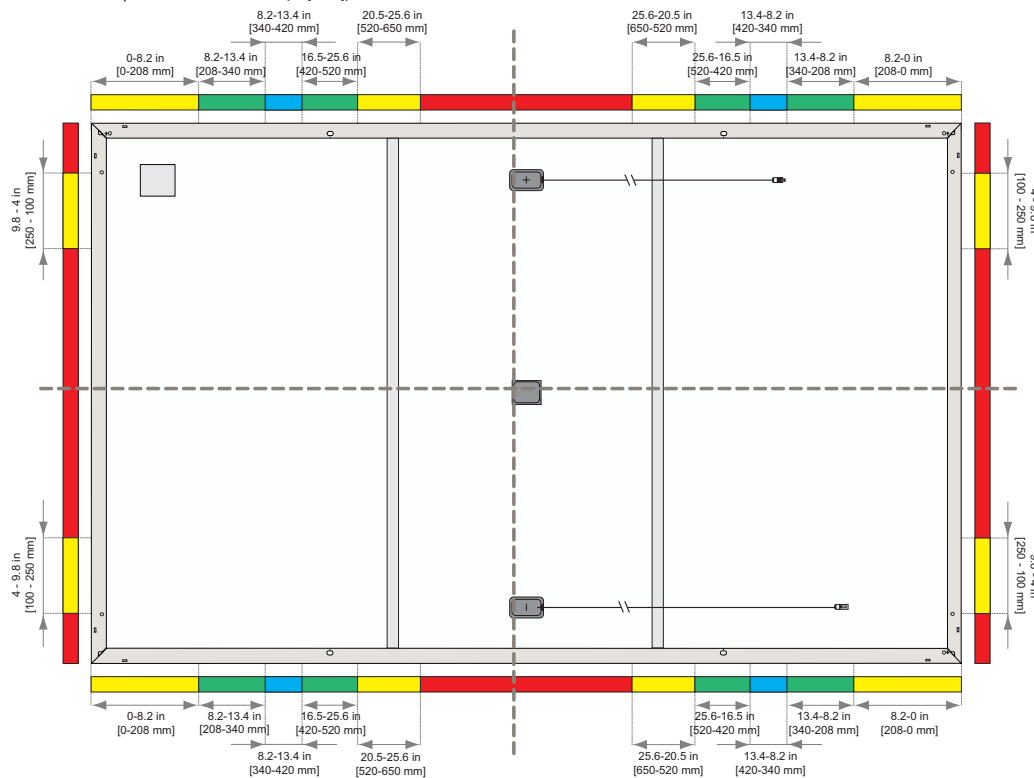

Fig. 3: Clamping zones for panels with rails parallel to short side (in [mm])



### Legend:

	Test Load		Design Load (= Test load / 1.5)	
	Max. downward load	Max. upward load	Max. downward load	Max. upward load
--- Panel quarter division				
<span style="background-color: #00b0f0; border: 1px solid black; display: inline-block; width: 15px; height: 10px;"></span> 13.4 - 16.5 in [340 - 420 mm]	146 psf (7000 Pa)	83.5 psf (4000 Pa)	97 psf (4666 Pa)	55.6 psf (2666 Pa)
<span style="background-color: #008000; border: 1px solid black; display: inline-block; width: 15px; height: 10px;"></span> 8.2 - 13.4 in, 16.5 - 25.6 in [208 - 340 mm; 420 - 520 mm]	112 psf (5400 Pa)	50 psf (2400 Pa)	75 psf (3600 Pa)	33 psf (1600 Pa)
<span style="background-color: #ffff00; border: 1px solid black; display: inline-block; width: 15px; height: 10px;"></span> 0 - 8.2 in, 20.5 - 25.6 in [0 - 208 mm; 520 - 650 mm] (long side)	50 psf (2400 Pa)	50 psf (2400 Pa)	33 psf (1600 Pa)	33 psf (1600 Pa)
<span style="background-color: #ff0000; border: 1px solid black; display: inline-block; width: 15px; height: 10px;"></span> 4 - 9.8 in [100 - 250 mm] (short side)				
<span style="background-color: #ff0000; border: 1px solid black; display: inline-block; width: 15px; height: 10px;"></span> Not permitted (in cases where only four (4) clamping points are used, additional clamps, i.e., ≥5 may be freely located on panel frame)				

**!** If the panel is secured in two different colored clamping zones, it is rated to the lower load value only.

## MOUNTING METHODS: CLAMPING WITH RAILS PARALLEL TO THE LONG SIDE

REC Alpha solar panels secured by clamping to mounting rails has been found to comply with UL 1703 & UL 61730 requirements for downward pressure, e.g., snow, of up to 112 psf (5400 Pa or 3600 Pa design load\*) and upward pressure, e.g., wind, of up to 50 psf (2400 Pa or 1600 Pa design load\*) according to the instructions below (\*design loads apply a safety factor of 1.5 to the stated test load, e.g., test load 5400 Pa / 1.5 = 3600 Pa design load). Site-specific factors such as high winds or snow levels must be taken into consideration to ensure this limit is not exceeded. These instructions must be followed for each clamping method used:

- Clamps must be positioned so that both the minimum grip length and the center point of each clamp are located in the required clamping zone,
- Follow the clamp manufacturer's instructions to install the clamps, including the recommended applied torque,
- The distance between the end clamp and the end of the rail must be a minimum of 1 in (25 mm).

When clamping to a rail-based construction, the rails must run underneath the panel to provide support to the frame. Where the rails are positioned parallel to the long side of the panel as per the examples shown in fig. 4, the clamping zones shown in fig. 5 are to be followed. The positioning of the rails must ensure that the minimum grip length of the clamp and the central point of the fixation, e.g., the bolt, is fully within the required clamping zone as indicated in fig. 3:

**!** Each panel must be clamped in a minimum of four separate zones, with one clamping point in each quarter of the panel (fig. 5).

Fig. 4: Clamping of panels with rails parallel to the long side

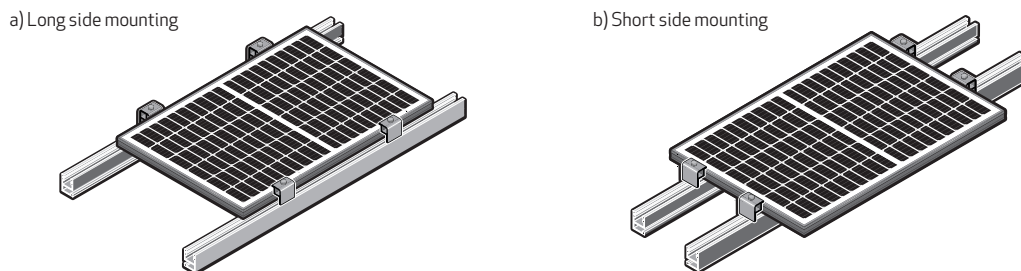
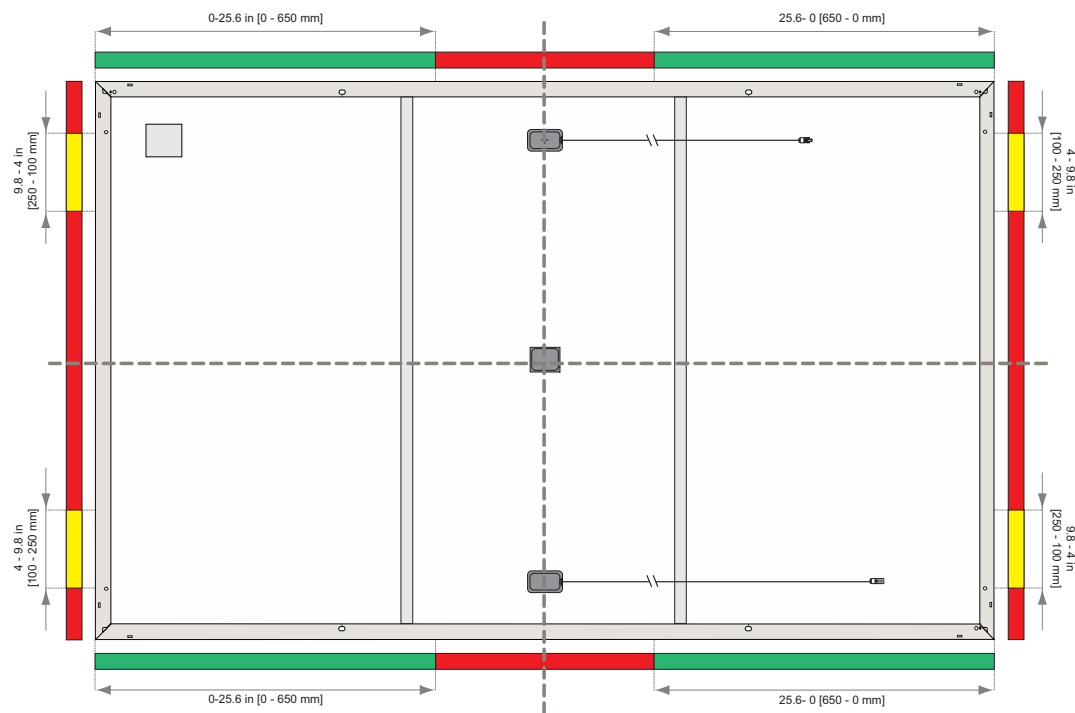

Fig. 5: Clamping zones for panels with rails parallel to long side (in [mm])



Legend:	Test Load		Design Load (= Test load / 1.5)	
	Max. downward load	Max. upward load	Max. downward load	Max. upward load
--- Panel quarter division				
<span style="color: green;">■</span> 0 - 25.6 in [0 - 650 mm]	112 psf (5400 Pa)	50 psf (2400 Pa)	75 psf (3600 Pa)	33 psf (1600 Pa)
<span style="color: yellow;">■</span> 4 - 9.8 in [100 - 250 mm]	50 psf (2400 Pa)	50 psf (2400 Pa)	33 psf (1600 Pa)	33 psf (1600 Pa)
<span style="color: red;">■</span> Not permitted (in cases where only four (4) clamping points are used, additional clamps, i.e., ≥5 may be freely located on panel frame)				

**!** If the panel is secured in two different colored clamping zones, it is rated to the lower load value only.



## MOUNTING METHODS: SLIDE IN SYSTEMS

REC Alpha panels may also be installed using 'slide-in systems', although such systems have not been tested to UL 1703 & UL 61730 in conjunction with REC panels. Where such mounting systems are used, they must meet the same specifications including grip lengths, depths and spacing as specified for clamping and the mounting system must be able to withstand the correct load pressures.

When installing solar panels using a slide-in system, the drainage holes found in the underside of the panel frame (see fig. 9) must not be covered. For any questions regarding installation on such systems, please contact REC directly.

## MOUNTING METHODS: MOUNTING HOLES

REC Alpha panels can be mounted utilizing the four 0.4 x 0.25 in (11 x 6.6 mm) elongated holes on the underside of the panel at a distance of 17.9 in (455 mm) from the corner (fig. 6) in conjunction with a device, e.g., screws, lockbolts or structural blind fasteners, with specifications suitable for the installation (fig. 7). Mounting in this way has been found to comply with UL 1703 & UL 61730 requirements for test loads of up to 5400 Pa (3600 Pa design load) downwards pressure and 2400 Pa (1600 Pa design load) upwards pressure (\*stated design loads apply a safety factor of 1.5 to the test load, e.g., 5400 Pa / 1.5 = 3600 Pa).

Fig. 6: Mounting holes: REC Alpha

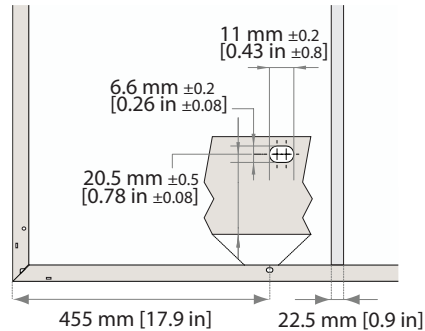

Fig. 7: Mounting hole specifications: REC Alpha

Part Name	Specification	Material
Rail		6105 - T5 aluminum extrusion
Bolt	1/4" x 20 - 5/8"	ASTM F593 (stainless steel)
Nut	1/4" x 20	ASTM F593 (stainless steel)

When installing using the mounting holes, the frame and panel edge of each panel must be supported by two rails (figs. 2b & 4b) of aluminium or galvanized steel suitable for the application and appropriate for the local environment. Observe the following procedures when using mounting holes:

- The mounting construction must be of a corrosion resistant material, e.g., aluminum or galvanized steel, and appropriate for the local environment,
- All four mounting holes in the frame must be used (fig. 8),
- Additional electrical bonding to Ground is required for the support structure,
- Refer to the fixing device manufacturer's installation instructions for preload or torque values.

Fig. 8: Mounting hole installation example: REC Alpha

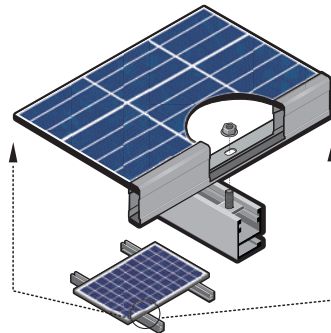

**The product warranty will be voided if additional holes are made in the frame. All fixing and fastening materials must be corrosion resistant.**

## DRAINAGE HOLES

Each corner of the REC panel frame has small drainage holes spaced 2.2 in (55 mm) from the corner of the panel frame that allow water caused by rain, condensation, snow melt, cleaning or any other process to exit the frame easily and minimize damage caused by freezing and thawing (fig. 9). These holes must not be used for mounting the panel, and they must not be covered by any part of the mounting structure.

**!** To enable effective drainage and ensure there is no damage to the panel, the drainage holes must remain fully open and enable water egress during and after installation.

**★** The shape and dimensions of the drainage holes may vary slightly from the below image depending on product and/or frame design.

Fig. 9: Drainage and grounding holes

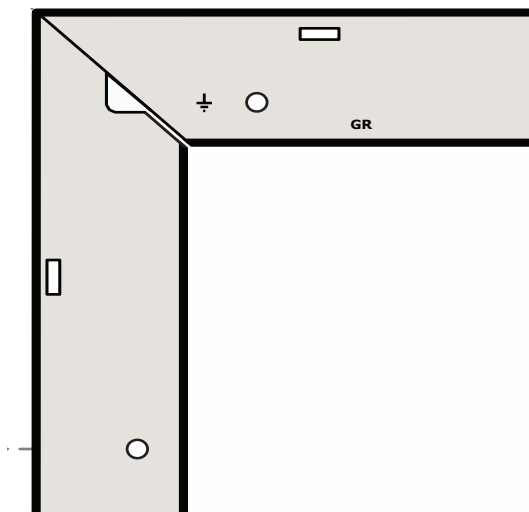

## GROUNDING

A panel with exposed conductive parts is considered to be in compliance with UL 1703 & UL 61730 only when it is electrically grounded in accordance with the instructions presented below and the requirements of the National Electrical Code. When grounding a panel, it must be done using an electrical connection from the panel frame. Local regulations may require grounding of the panels. Where grounding is necessary or desired, it must be done using an electrical connection from the panel frame. REC solar panels have a small round grounding hole positioned near each corner of the panel on both the long side and the short side, as shown in fig. 9, to aid in grounding. These can be further identified by the grounding symbol stamped in the frame next to it on the long side. The support bars across the rear of REC Alpha solar panels are connected to the frame via specially designed grounding clips and do not need to be individually grounded. Check all applicable requirements before beginning installation. Grounding is achieved through securement to the panel frame of the following UL Listed grounding Clips / Lugs in combination with the REC panel(s).

- Suitable grounding lugs must be used: Listed (KDER) ILSCO, GBL-4DBT (tin plated) (E34440),
- Grounding cable size should be between 4 - 14 AWG (2.1 mm<sup>2</sup> - 21.2 mm<sup>2</sup>),
- Attach grounds to the grounding holes in the panel frames,
- Fix lug to the frame using a star washer (#10) and lock nut (#10), ensuring a conductive connection (fig. 10),
- Follow the grounding device manufacturer's installation instructions to ensure a safe and conductive connection, including any supplementary hardware, e.g., star washer, and tighten according to recommended torque.

Fig. 10: Grounding lug dimensions and fastening torque for GBL-4DBT

Cross section [AWG]	Type	Torque [in-lbs]
4 - 6	Stranded	35
8	Stranded	25
10 - 14	Stranded/Solid	2.8

**!** Where common grounding hardware (nuts, bolts, star washers, split-ring lock washers, flat washers and the like) are used to attach a grounding device, the attachment must be made in conformance with the grounding device manufacturer's instructions.

**★** To avoid galvanic corrosion, galvanized or hot dipped zinc plated fasteners are preferred, however stainless steel fastening materials are equally suitable.

**★** Negative grounding of the panels is not required by REC.

# CONNECTIONS AND CONNECTORS

The connectors used on REC solar panels are specified in the panel characteristics at the rear of this manual. The connector IP rating is only valid when they are correctly connected. All connectors and cables must be secure and tight as well as electrically and mechanically sound. UV-resistant cables and connectors approved for outdoor use must be used. Conductor gauge must be chosen to ensure DC power losses (voltage drop) are kept to a minimum (<1%).

Observe all local regulations when selecting cables. For string connections, use minimum 12 AWG (4 mm<sup>2</sup>) or copper wires insulated for a maximum operating temperature of 194°F (90°C). Secure cables using UV-resistant cable ties or other device. Loose and unsecured cables must be protected from damage (e.g., mechanical, abrasion, sharp objects, animals). Avoid exposing cables to direct sunlight and permanent tension.

In order to ensure durable and safe connections between panels and BOS equipment, the following instructions must be followed in order to protect the electrical connections from the elements. More detailed information is given in the *Guide to Best Practice - Connections and Connectors* which can be found via the REC online Download Center ([www.recgroup.com/downloads](http://www.recgroup.com/downloads)).

Safety is paramount when working with electrical connectors. Ensure that any installation work is not carried out on live or load-carrying parts. Connections must not be disconnected under load and the system must be isolated from the grid before carrying out any maintenance or repair work.

## CONNECTORS

The exact connector type used on REC solar panels is indicated in the product specifications at the rear of this manual. The stated IP rating is only valid when correctly mated. To ensure connector compatibility and reduce the potential for damage to the modules and the installation, mated connectors must be from the same manufacturer and of the same (i.e., mateable) connector type and system rating. Connections may also be made using connectors that are certified as mateable.

**★ Some countries and/or regions have specific regulations regarding the mating of connectors. Installers are responsible for ensuring the compliancy of the system with such local regulations.**

- The correct and secure connection of connectors is identified by a firm click once inserted,
- Use of any chemicals or lubricants on the connectors or contacts may only be carried out in line with the connector manufacturer's instructions.

**⚠ The cutting of cables is only permitted in order to replace a factory-installed connector with another brand of connector to ensure 'like-for-like' mating when connected to a non-REC external device. All other changes are prohibited and will invalidate the REC warranty. The connector replacement procedure must be carried out by the installer correctly and according to the replacement connector manufacturer's instructions. The selected replacement connector must also fulfil all relevant technical specifications and be certified according to applicable standards (e.g., EN 50521, IEC 62852 or UL 6703) so as to ensure they are fit for purpose and safety. The REC warranty does not extend to cover any fault traceable to the replaced connectors.**

**⚠ Any other modification to the panel is prohibited, including the opening of the junction box, unless explicitly authorized by REC. Doing so will invalidate the warranty.**

## PROTECTING THE CABLES

- To prevent stress on the junction box casing, ensure the cable exits the junction box in a straight line before any bend in the cable.
- The cables on REC solar panels have a minimum bending radius of 1.2 in (30 mm) to avoid damage to the insulation (fig. 11).

Fig. 11: Minimum cable bend radius

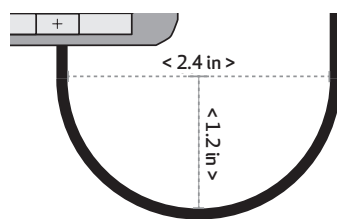

- Ensure cables do not hang loose where they may be damaged through friction or stress, e.g., caused by wind or grazing animals,
- Shield connectors from falling or dropping water by locating them directly beneath a panel,
- Cables must be firmly secured to the structure, without over-tightening, as this can deform the cable insulation.

## SECURING CABLES AND CONNECTORS

- When securing the connector, place it so that it has with sufficient air circulation all around. This allows the connector to dry effectively and avoids the risk of damage or degradation of the connection,
- Good practice is to secure the cable either side of the connectors, ensuring no stress is exerted on the connector casing or cable entry.

**⚠ To enable correct cooling and drying of the connectors, do not add extra protection to the connector, e.g., heat shrink, grease or tape.**

# MAINTENANCE

## CLEANING INSTRUCTIONS

REC solar panels have been designed for easy maintenance. The need for cleaning the solar panels will vary dependent on location, rainfall, air pollution levels and the angle of installation – the lower the angle of installation, the more cleaning will be required. 'Normal' rainfall will naturally clean the panels if installed at a sufficient angle. To optimize electrical output it is recommended to clean the panels when dirt can be seen on the glass surface.

 **Panel cleaning should always be carried out when the panels are cool to avoid breakage through thermal shock, e.g., early morning.**

The build up of dirt on the panel surface over time may cause cell shading which will reduce power output or can even cause further damage. To clean either the front or rear of the panels, use only deionized water free from grit and physical contaminants, at ambient temperature and use a sponge, microfiber cloth or a soft brush to wipe away the dirt (rainwater, tap water or diluted alcohol may also be used as a secondary solution). For further cleaning a mild, biological and biodegradable washing-up liquid may be used.

When cleaning the panel, take care not to scratch the surface or introduce foreign elements that may cause damage. Ensure the water used is free from grit and physical contaminants that may damage the panel. Always rinse the panel with plenty of water. If soiling remains on the panel, repeat the cleaning process. If stains require more effort to be removed, Isopropyl alcohol of a concentration less than 10% may be used. Acid or Alkali detergent may not be used.

 **Use of high pressure hoses or cleaners is not permitted as these may damage the panels, laminate or cells.**

Using a soft rubber squeegee, wipe the panel surface from the top downwards to remove any residual water from the panel glass. Panels can be left to dry in the air or wiped dry with a clean and soft cloth or chamois. Avoid putting pressure on the on the panel surface when drying, e.g., leaning or standing on it. For more information on cleaning REC solar panels, consult the *REC Cleaning Information Sheet* which is available to download from the online REC Download Center [www.recgroup.com/downloads](http://www.recgroup.com/downloads). If in doubt at any time when cleaning the panels, stop and obtain professional advice.

## SYSTEM INSPECTION

The system should be inspected regularly to ensure that:

- Fasteners are secure, tight and free from corrosion,
- Electrical connections are secure, tight, clean, and free of corrosion,
- The mechanical integrity of the cables is intact,
- Bonding points to ground are tight, secure and free from corrosion (which could break the continuity between the panels and ground).

## RECYCLING

REC makes every effort to ensure panel packaging is kept to a minimum. The paper and cardboard packaging can be recycled and the protective wrapping and panel separating blocks are also recyclable in many areas. Recycle packaging and panels according to local guidelines and regulations.

## DISPOSAL OF OLD ELECTRICAL AND ELECTRONIC EQUIPMENT

Panels should be recycled at the end of their useful life according to local guidelines and regulations. By ensuring REC solar panels are disposed of correctly, you will help prevent potential negative consequences for the environment and human health which could otherwise be caused by inappropriate waste treatment. The majority of the panel components can be recycled.



# PANEL CHARACTERISTICS

## TECHNICAL PROPERTIES: REC ALPHA SERIES

Fig. 12: Panel dimensions: REC Alpha Series

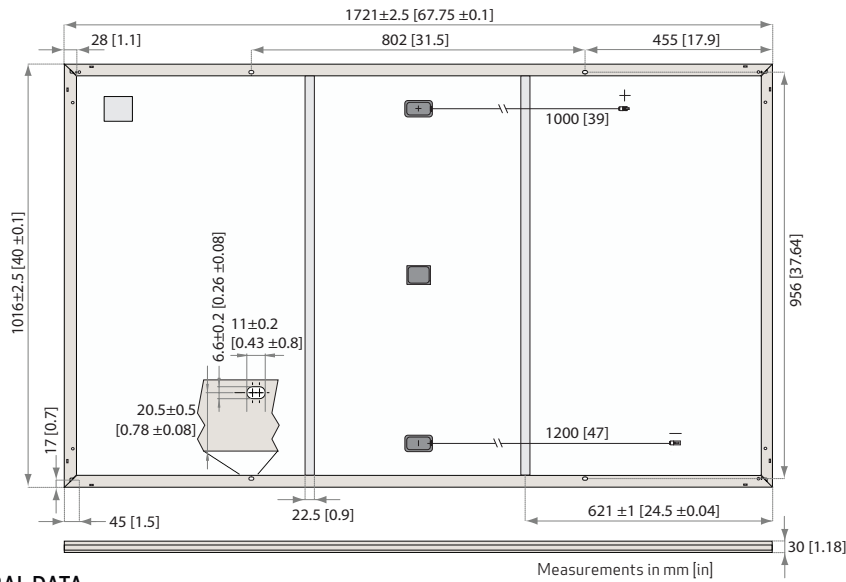

### GENERAL DATA

Cell type:	120 half-cut cells with REC heterojunction cell technology 6 strings of 20 cells in series	Junction box:	3-part, 3 bypass diodes, IP67 rated in accordance with IEC 62790
Glass:	0.13 in (3.2 mm) solar glass with anti-reflection surface treatment	Cable:	12 AWG (4 mm <sup>2</sup> ) PV wire, 39+47 in (1+1.2 m) in accordance with EN 50618
Backsheet:	Highly resistant polymeric construction	Connectors:	Stäubli MC4PV-KBT4/KST4, 12 AWG (4 mm <sup>2</sup> ) in accordance with IEC 62852 IP68 only when connected
Frame:	Anodized aluminum (black)	Origin:	Made in Singapore

### ELECTRICAL DATA @ STC

#### Product Code\*: RECxxxAA

	360	365	370	375	380
Nominal Power - P <sub>MPP</sub> (Wp)	360	365	370	375	380
Watt Class Sorting - (W)	-0/+5	-0/+5	-0/+5	-0/+5	-0/+5
Nominal Power Voltage - V <sub>MPP</sub> (V)	37.7	38.0	38.3	38.7	39.0
Nominal Power Current - I <sub>MPP</sub> (A)	9.55	9.60	9.66	9.72	9.76
Open Circuit Voltage - V <sub>OC</sub> (V)	44.1	44.3	44.5	44.6	44.7
Short Circuit Current - I <sub>SC</sub> (A)	10.23	10.26	10.30	10.40	10.46
Panel Efficiency (%)	20.6	20.9	21.2	21.4	21.7

Values at standard test conditions (STC: air mass AM1.5, irradiance 10.75 W/sq ft (1000 W/m<sup>2</sup>), temperature 77°F (25°C), based on a production spread with a tolerance of V<sub>OC</sub> & I<sub>SC</sub> ±3% within one watt class. \*Where xxx indicates the nominal power class (P<sub>MPP</sub>) at STC above.

### ELECTRICAL DATA @ NMOT

#### Product Code\*: RECxxxAA

	274	278	282	286	290
Nominal Power - P <sub>MPP</sub> (Wp)	274	278	282	286	290
Nominal Power Voltage - V <sub>MPP</sub> (V)	35.5	35.8	36.1	36.4	36.7
Nominal Power Current - I <sub>MPP</sub> (A)	7.71	7.76	7.80	7.85	7.88
Open Circuit Voltage - V <sub>OC</sub> (V)	41.6	41.7	41.9	42.0	42.1
Short Circuit Current - I <sub>SC</sub> (A)	8.26	8.29	8.32	8.40	8.45

Nominal module operating temperature (NMOT: air mass AM1.5, irradiance 800 W/m<sup>2</sup>, temperature 68°F (20°C), windspeed 3.3 ft/s (1 m/s). \*Where xxx indicates the nominal power class (P<sub>MPP</sub>) at STC above.

### CERTIFICATIONS

IEC 61215:2016, IEC 61730:2016, UL 1703, UL 61730	
IEC 62804	PID
IEC 61701	Salt Mist
IEC 62716	Ammonia Resistance
UL 1703	Fire Type Class 2
IEC 62782	Dynamic Mechanical Load
IEC 61215-2:2016	Hailstone (35mm)
AS4040.2 NCC 2016	Cyclic Wind Load
ISO 14001:2004, ISO 9001:2015, OHSAS 18001:2007	



### WARRANTY

20 year product warranty  
25 year linear power output warranty  
Maximum annual power degradation of 0.25% p.a.  
Guarantees 92% of power after 25 years  
See warranty conditions for further details.

### MECHANICAL DATA

Dimensions:	678 x 40 x 1.2 in (1721 x 1016 x 30 mm)
Area:	18.8 sq ft (1.75 m <sup>2</sup> )
Weight:	43 lbs (19.5 kg)

### MAXIMUM RATINGS

Operational temperature:	-40 ... +85°C
Maximum system voltage:	1000 V
Design load (+): snow	4666 Pa (97.5 lbs/sq ft)*
Maximum test load (+):	7000 Pa (146 lbs/sq ft)*
Design load (-): wind	2666 Pa (55.6 lbs/sq ft)*
Maximum test load (-):	4000 Pa (83.5 lbs/sq ft)*
Max series fuse rating:	25 A
Max reverse current:	25 A

\* Calculated using a safety factor of 1.5  
\* See installation manual for mounting instructions

### TEMPERATURE RATINGS\*

Nominal Module Operating Temperature:	44°C (±2°C)
Temperature coefficient of P <sub>MPP</sub> :	-0.26 %/°C
Temperature coefficient of V <sub>OC</sub> :	-0.24 %/°C
Temperature coefficient of I <sub>SC</sub> :	0.04 %/°C

\*The temperature coefficients stated are linear values

### LOW LIGHT BEHAVIOUR

Typical low irradiance performance of module at STC:

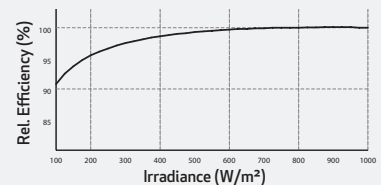

Specifications subject to change without notice.

Ref: PM-D5-12-01-Rev-B 08.19

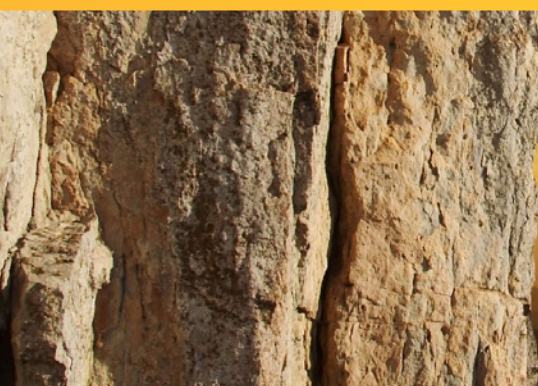

Founded in Norway in 1996, REC is a leading vertically integrated solar energy company. Through integrated manufacturing from silicon to wafers, cells, high-quality panels and extending to solar solutions, REC provides the world with a reliable source of clean energy. REC's renowned product quality is supported by the lowest warranty claims rate in the industry. REC is a Bluestar Elkem company with headquarters in Norway and operational headquarters in Singapore. REC employs around 2,000 people worldwide, producing 1.5 GW of solar panels annually.



www.recgroup.com



## TECHNICAL PROPERTIES: REC ALPHA BLACK SERIES

Fig. 13: Panel dimensions: REC Alpha Black Series

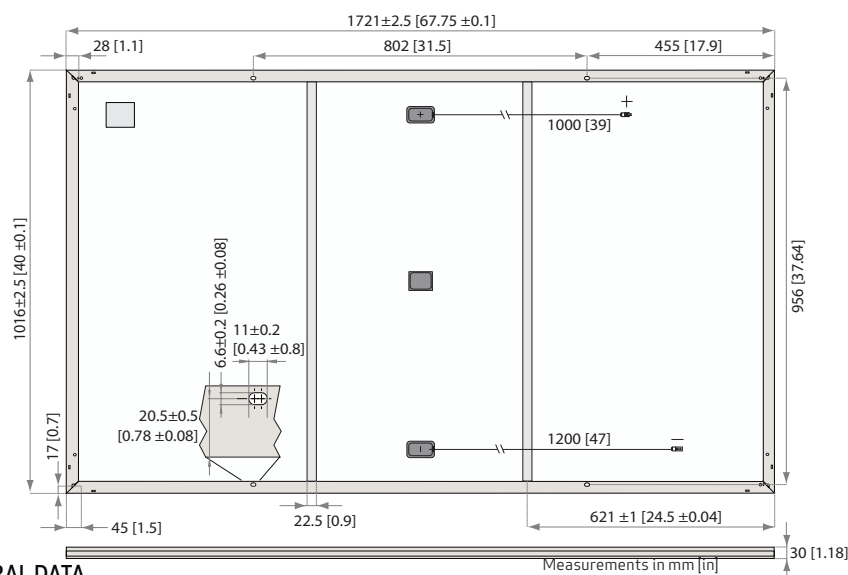

### GENERAL DATA

Cell type:	120 half-cut cells with REC heterojunction cell technology 6 strings of 20 cells in series	Junction box:	3-part, 3 bypass diodes, IP67 rated in accordance with IEC 62790
Glass:	0.13 in (3.2 mm) solar glass with anti-reflection surface treatment	Cable:	12 AWG (4 mm <sup>2</sup> ) PV wire, 39+47 in (1+1.2 m) in accordance with EN 50618
Backsheet:	Highly resistant polymeric construction	Connectors:	Stäubli MC4PV-KBT4/KST4, 12 AWG (4 mm <sup>2</sup> ) in accordance with IEC 62852 IP68 only when connected
Frame:	Anodized aluminum (black)	Origin:	Made in Singapore

### ELECTRICAL DATA @ STC

#### Product Code\*: RECxxxAA Black

	355	360	365	370	375
Nominal Power - P <sub>MPP</sub> (Wp)	355	360	365	370	375
Watt Class Sorting - (W)	-0/+5	-0/+5	-0/+5	-0/+5	-0/+5
Nominal Power Voltage - V <sub>MPP</sub> (V)	37.4	37.7	38.0	38.3	38.7
Nominal Power Current - I <sub>MPP</sub> (A)	9.50	9.55	9.60	9.66	9.72
Open Circuit Voltage - V <sub>OC</sub> (V)	44.0	44.1	44.3	44.5	44.6
Short Circuit Current - I <sub>SC</sub> (A)	10.19	10.23	10.26	10.30	10.40
Panel Efficiency (%)	20.3	20.6	20.9	21.2	21.4

Values at standard test conditions (STC: air mass AM1.5, irradiance 10.75 W/sq ft (1000 W/m<sup>2</sup>), temperature 77°F (25°C), based on a production spread with a tolerance of V<sub>OC</sub> & I<sub>SC</sub> ±3% within one watt class. \*Where xxx indicates the nominal power class (P<sub>MPP</sub>) at STC above.

### ELECTRICAL DATA @ NMOT

#### Product Code\*: RECxxxAA Black

	270	274	278	282	286
Nominal Power - P <sub>MPP</sub> (Wp)	270	274	278	282	286
Nominal Power Voltage - V <sub>MPP</sub> (V)	35.2	35.5	35.8	36.1	36.4
Nominal Power Current - I <sub>MPP</sub> (A)	7.67	7.71	7.76	7.80	7.85
Open Circuit Voltage - V <sub>OC</sub> (V)	41.4	41.6	41.7	41.9	42.0
Short Circuit Current - I <sub>SC</sub> (A)	8.23	8.26	8.29	8.32	8.40

Nominal module operating temperature (NMOT: air mass AM1.5, irradiance 800 W/m<sup>2</sup>, temperature 68°F (20°C), windspeed 3.3 ft/s (1 m/s). \*Where xxx indicates the nominal power class (P<sub>MPP</sub>) at STC above.

### CERTIFICATIONS

IEC 61215:2016, IEC 61730:2016, UL 1703, UL 61730	
IEC 62804	PID
IEC 61701	Salt Mist
IEC 62716	Ammonia Resistance
UL 1703	Fire Type Class 2
IEC 62782	Dynamic Mechanical Load
IEC 61215-2:2016	Hailstone (35mm)
AS4040.2 NCC 2016	Cyclic Wind Load
ISO 14001:2004, ISO 9001:2015, OHSAS 18001:2007	



### WARRANTY

20 year product warranty  
25 year linear power output warranty  
Maximum annual power degradation of 0.25% p.a.  
Guarantees 92% of power after 25 years  
See warranty conditions for further details.

### MECHANICAL DATA

Dimensions:	678 x 40 x 1.2 in (1721 x 1016 x 30 mm)
Area:	18.8 sq ft (1.75 m <sup>2</sup> )
Weight:	43 lbs (19.5 kg)

### MAXIMUM RATINGS

Operational temperature:	-40 ... +85°C
Maximum system voltage:	1000 V
Design load (+): snow	4666 Pa (97.5 lbs/sq ft)*
Maximum test load (+):	7000 Pa (146 lbs/sq ft)*
Design load (-): wind	2666 Pa (55.6 lbs/sq ft)*
Maximum test load (-):	4000 Pa (83.5 lbs/sq ft)*
Max series fuse rating:	25 A
Max reverse current:	25 A

\* Calculated using a safety factor of 1.5  
\* See installation manual for mounting instructions

### TEMPERATURE RATINGS\*

Nominal Module Operating Temperature:	44°C (±2°C)
Temperature coefficient of P <sub>MPP</sub> :	-0.26 %/°C
Temperature coefficient of V <sub>OC</sub> :	-0.24 %/°C
Temperature coefficient of I <sub>SC</sub> :	0.04 %/°C

\*The temperature coefficients stated are linear values

### LOW LIGHT BEHAVIOUR

Typical low irradiance performance of module at STC:

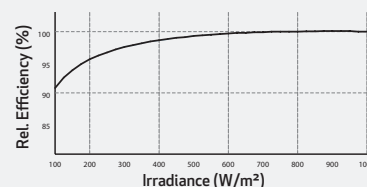

Specifications subject to change without notice.

Ref: PM-D5-12-02-Rev-B\_08.19

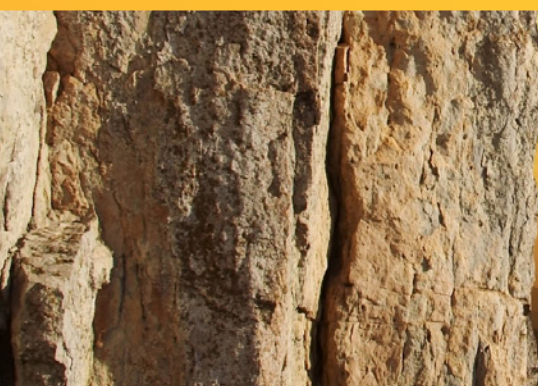

Founded in Norway in 1996, REC is a leading vertically integrated solar energy company. Through integrated manufacturing from silicon to wafers, cells, high-quality panels and extending to solar solutions, REC provides the world with a reliable source of clean energy. REC's renowned product quality is supported by the lowest warranty claims rate in the industry. REC is a Bluestar Elkem company with headquarters in Norway and operational headquarters in Singapore. REC employs around 2,000 people worldwide, producing 1.5 GW of solar panels annually.



www.recgroup.com



# ANNEX 1: INSTALLATIONS ON WATER PLATFORMS

This section is applicable to the following products only (other panel types have not yet been qualified for installations on water platforms):

- REC Alpha Series & REC Alpha Black Series

The above named REC solar panels may be installed on water platform-type mounting systems (note that the certification testing of solar panels does not include testing on these types of systems). When installing any of the above named REC solar panels on fixed position (e.g., anchored) water platforms, for example, floating pontoons, follow the instructions below specific to such applications. Failure to do so will invalidate the warranty.

 **For all installations on water platforms, first advise REC before the start of installation in case of any site specific instructions or constraints.**

## INSTALLATION ENVIRONMENT

### i) Installation site

- REC solar panels may only be installed on closed bodies of fresh water where water salinity does not exceed 15 PSU (25 mS/cm) at 77°F (25°C). This specifically excludes mounting on sea and ocean applications.
- The maximum permitted wave height must not exceed 1 m from the crest to the trough of the wave.

### ii) Floating platforms

- When using a floating platform, follow the manufacturer's instructions regarding installation, maintenance, inspection and cleaning at all times.

### iii) Minimum installation height

- The minimum installation height of REC solar panels on floating platform systems is 6 in (15 cm) and is defined as the height between the water surface and the lowest edge/part of the panel during normal operation. This will help to shield the panel from direct water spray.

## INSTALLATION INSTRUCTIONS

### i) System installation

- All cables used for the installation must have sufficient length and slack to prevent damage due to water level changes and wave motions.

 **Negative system grounding is required for REC solar panels installed on a floating platform.**

### ii) Mounting panels

- Installation of REC solar panels must be in accordance with the aforementioned standard mounting instructions.
- The junction box should be oriented as far as possible from the water surface according to system design and the junction box, cables and connectors must be protected from direct water splash.
- The installation must allow for sufficient spacing between individual panels, in order to avoid all contact as caused by the natural movement and flexing of the floating structure.

### iii) Panel protection

- In areas with high avian activity, additional bird repelling devices may be installed as long as they do not adversely affect system performance, e.g., shading or to the local environment etc.
- If using lightning protection equipment on the floating installation, all relevant local regulations must be respected.

## MAINTENANCE

- Regularly inspect the installation to ensure all panels are securely mounted.

 **For installations with high avian activity, system cleaning may be required at more frequent intervals to reduce shading of panels caused by bird defecation.**

## SAFETY

- Immediately disconnect the system if the installation or the floating platform exhibits deviation from standard operating conditions.
- In the event of the floating platform being submerged, disconnect the DC connection at the inverter immediately. Do not attempt to salvage panels when sunlight is present.

# ANNEX 2: INSTALLATIONS USING RAPID SHUTDOWN DEVICES

This section is applicable to all REC products referred to in this installation manual.

Rapid Shutdown (RSD) is the name given to the range of panel-level components that can be installed in PV system circuits installed on or in buildings to reduce shock hazard for emergency responders. RSD devices can be supplied pre-installed by panel manufacturers or as a 'retro-fit' system made by third-party manufacturers. From January 1, 2019, Section 690.12 of the 2017 National Electrical Code (NEC) (in the U.S.A.) requires the panel-level rapid shutdown of solar systems (replacing the previous array-level shutdown requirement of NEC 2014). This means that all conductors within an array's 1-ft (300 mm) boundary have to be reduced to 80 V or less within 30 seconds of rapid shutdown initiation.



RSD devices may be used on REC solar panels where desirable or mandatory (note that the certification testing of solar panels does not include testing with RSD devices). When installing an RSD device on an REC solar panel, follow the instructions provided by the device manufacturer and the instructions specific for REC solar panels given below. Failure to follow the manufacturer and the REC instructions may invalidate the warranty.

## INSTALLATION



### i) Installation

- RSD devices are suitable for use wherever solar panels are suitable for installation. Observe any limitations set by the RSD manufacturer. (e.g., minimum mounting gap between RSD and rooftop).
- When attaching an RSD device to a solar panel, it must be secured to the panel frame. Follow RSD manufacturer instructions to ensure optimum mounting of RSD device and prevent any slippage during operation.
- RSD devices may also be attached to the mounting construction. In such cases, refer to the instructions provided by the manufacturer.
- Wherever possible, the installation of the RSD device should not cover the product label on the rear of the panel.
- RSD devices may only be installed on REC solar panels in the areas shown in the diagram below (fig. 14):

Fig. 14: RSD device installation zones

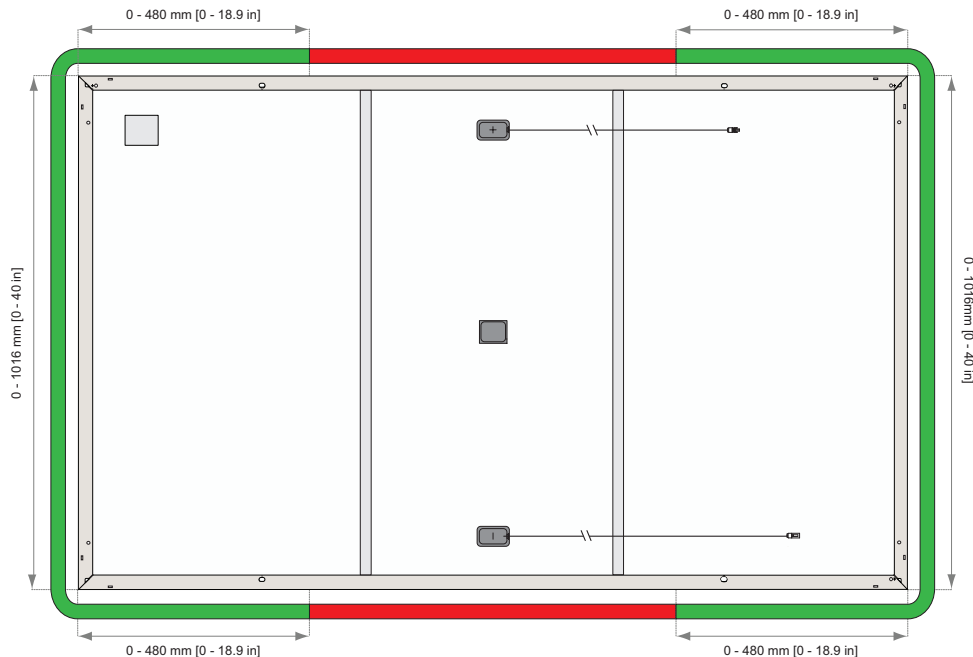
-  Installation of RSD device in the green zone is permitted.
-  Installation of RSD device in the red zone is not permitted.



-  **To avoid damage to the panel and to allow for thermal expansion, there must be a minimum gap of 0.1 in (2.5 mm) between the RSD device and the panel backsheet.**
-  **The mounting holes in the panel frame must not be used for the installation of RSD devices.**
-  **The drilling of extra holes in the frame is not permitted and will invalidate the panel warranty.**

## CONNECTION

- First ensure the installation of the RSD device is secure and safe.
- Following the device manufacturer's instructions to connect the cables from the RSD device to the solar panel correctly (usually positive to positive [+ to +] and negative to negative [- to -]).
- Connection to the next panel in the array should be done from the 'free' cables.

## SAFETY

- Immediately disconnect the device if there is a problem during installation.



# DOCUMENT HISTORY

<b>Date</b>	<b>Revision Number</b>	<b>Reason</b>
04.2019	A	First release
08.2019	B	Updated Datasheet



REC SOLAR PTE. LTD.  
20 TUAS SOUTH AVENUE 14  
SINGAPORE 637312  
Tel: +65 6495 9228  
Mail: [post@recgroup.com](mailto:post@recgroup.com)

[www.recgroup.com](http://www.recgroup.com)