

Roof Mounting System

2015 Edition v1.66

This **Engineering Design Guide** was created to help our engineering partners more easily design and specify PV roof mount applications using IronRidge components. In addition to this document, IronRidge provides a complete system of technical support including installation guides, pre-stamped certification letters for most PV-friendly states, our online Design Assistant software, and live, knowledgeable person-to-person customer service.

Overview

- 1 Introduction
Technical Specifications
- 2 Assembled Views
- 3 Component View
- 4 Assembly CAD Details

System Parts

- 5 XR Rail
- 6 Internal Splice
End Clamp
Mid Clamps
- 7 Adjustable L-Foot
FlashFoot™
Under Clamp
- 8 Flush Mount Standoff
Tilt Mount Standoff
Fixed Tilt Length Leg
- 9 Adjustable Tilt Length Leg
Grounding Strap
Wire Clips
End Caps
- 10 Grounding

Design Assistant

- 11 Summary

Engineering Data

- 12 Code Compliance
Thermal Expansion
Engineering Assumptions
- 13 AWC Lag Pull-Out Chart

Part Sizing & Part Numers

- 14 Rails & Splices
Clamps
- 15 Clamps
- 16 Attachments
- 17 Accessories
Grounding

Support

- 18 System Support
Downloadable Support Documents
3rd Party Partners
Design Assistant
- 19 Engineering Services
Customer Service

Warranty

- 20 Warranty Information

Introduction

IronRidge provides a comprehensive platform for designing a wide variety of photovoltaic systems for roof mounting applications. Due to its modular architecture, it can handle nearly all commercially available PV modules and layout designs. The IronRidge Roof Mount provides an all-in-one mounting solution, with the roof attachment FlashFoot, XR rails, and integrated grounding. IronRidge products are engineered to last in the most extreme weather conditions and have been installed in every continent in the world.

Technical Specifications

Below is a brief summary of the technical specifications of the IronRidge Roof Mount platform. More detail will be provided in the following pages. If there is additional information you require that is not listed in this Engineering Design Guide, please do not hesitate to contact us at support@ironridge.com.

Allowable Roof Slope	0 to 45 Degrees	Warranty	20 Year
Span Lengths	Up to 12'	Tilt Legs	Yes (10" to 40")
Rail Lengths	Standard & Custom	Adjustable Tilt Legs	Up to 45 Degrees
Rail Finish	Clear, Black	Adjustable L Feet	1-1/8" vertical adjustability
Building Height	Certified to 60'	Splices	Patent-pending internal
Max Wind Speed	170 Mph (for 7-10)	Stand-offs	Yes (3", 4", 6", 7")
Module Orientation	Landscape & Portrait	Tilt Stand-offs	Yes (3.75", 6", 9")
Wind Exposure	Category B, C & D	Flashing	FlashFoot (All-in-One Attachment)
Cantilever	40% of Maximum Span	T-bolts	Multiple Sizes
Max Ground Snow Load	90 psf	Wire Clips	Black Polycarbonate
Component Materials	Aluminum and Stainless Steel	End Caps	Black Polycarbonate
Hardware	Stainless Steel Fasteners	Engineering Support	Yes (P.E. Certified)

Assembled Views

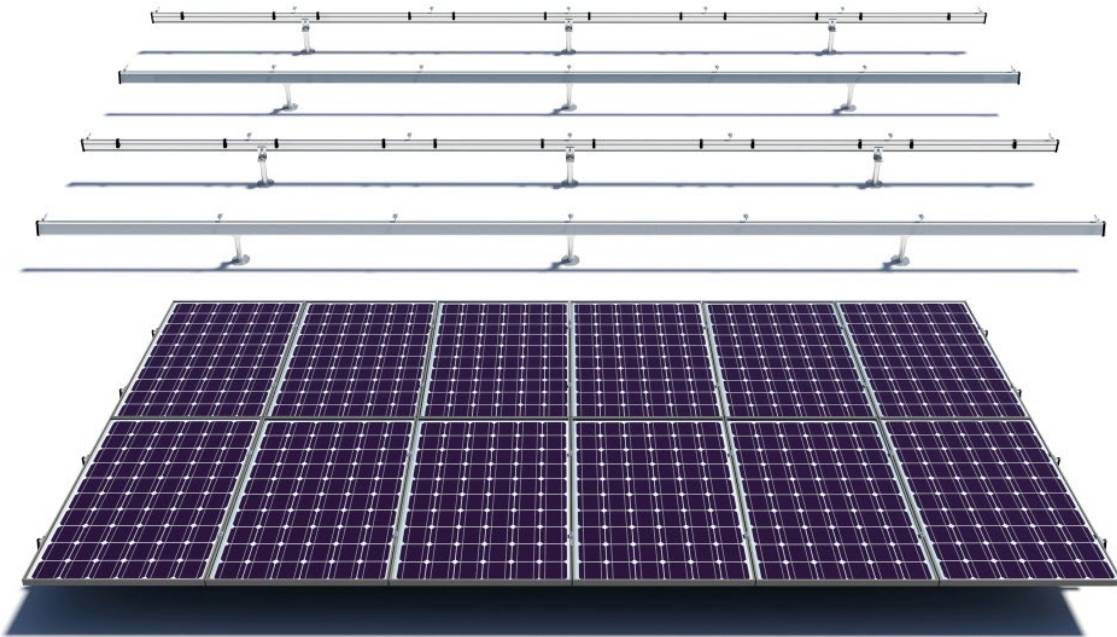

Flush Mounted

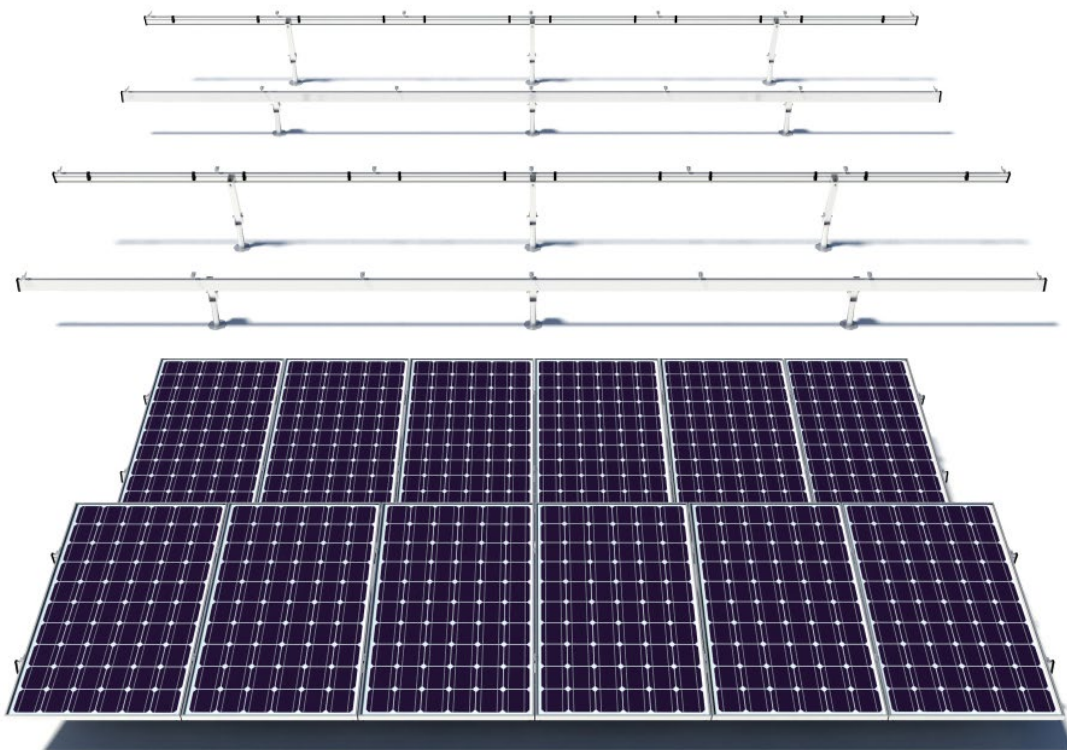

Tilt Mounted

For a complete 360 degree interactive roof mounting viewing environment, go to: ironridge.com/products/roofmounting/360view.

XR Rails

XR10 Rail



A low-profile mounting rail for regions with light snow.

- 6' spanning capability
- Moderate load capability
- Clear anodized finish

XR100 Rail



The ultimate residential solar mounting rail.

- 8' spanning capability
- Heavy load capability
- Clear & black anod. finish

XR1000 Rail



A heavyweight mounting rail for commercial projects.

- 12' spanning capability
- Extreme load capability
- Clear anodized finish

Internal Splices

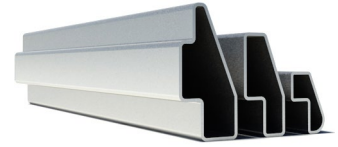

All rails use internal splices for seamless connections.

- Self-tapping screws
- Varying versions for rails
- Grounding Straps offered

Attachments

FlashFoot



Anchor, flash, and mount with all-in-one attachments.

- Ships with all hardware
- IBC & IRC compliant
- Certified with XR Rails

Slotted L-Feet



Drop-in design for rapid rail attachment.

- High-friction serrated face
- Heavy-duty profile shape
- Clear & black anod. finish

Standoffs



Raise flush or tilted systems to various heights.

- Works with vent flashing
- Ships pre-assembled
- Lengths from 3" to 9"

Tilt Legs



Tilt assembly to desired angle, up to 45 degrees.

- Attaches directly to rail
- Ships with all hardware
- Fixed and adjustable

Clamps & Grounding

End Clamps

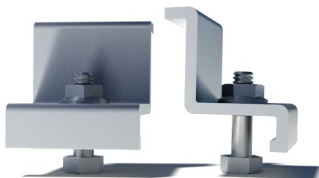

Slide in clamps and secure modules at ends of rails.

- Clear and black anod.
- Sizes from 1.22" to 2.3"
- Optional Under Clamps

Mid Clamps



Attach and ground modules in the middle of the rail.

- Parallel bonding T-bolt
- Reusable up to 10 times
- Mill & black stainless

Grounding Lugs

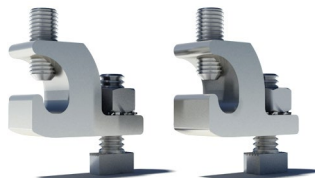

Ground system using the rail's top slot.

- No clips or washers
- Eliminates pre-drilling
- Easy top-slot mounting

Accessories



Provide a finished and organized look for rails.

- Snap-in Wire Clips
- Perfected End Caps
- UV-protected polymer

Assembly CAD Details

[Download AutoCAD File](#) | [Download PDF](#)

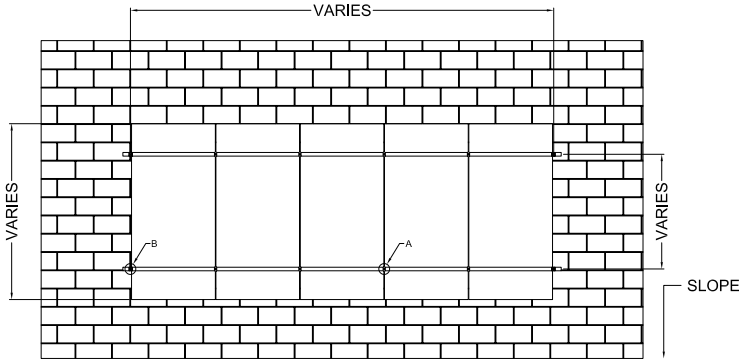

Typical Flush Mount Array - Plan View
1/2" = 1' -0"

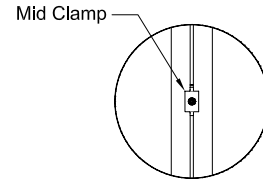

Detail A - Mid Clamp to Rail - Plan
3" = 1' -0"

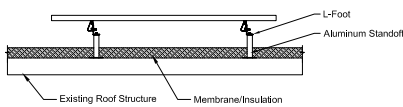

Section - Flush Mount - Flat Roof
3/4" = 1' -0"

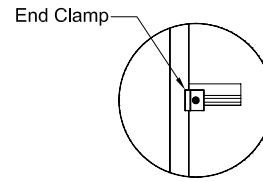

Detail B - End Clamp to Rail - Plan
3" = 1' -0"

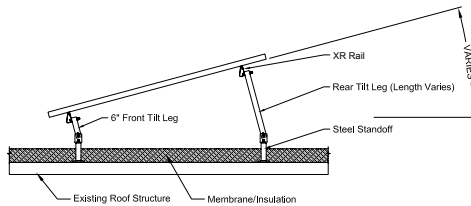

Section - Tilt Mount - Flat Roof
3/4" = 1' -0"

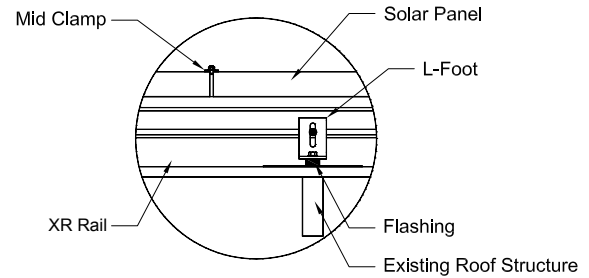

Detail C - Typical Roof Connection
3" = 1' -0"

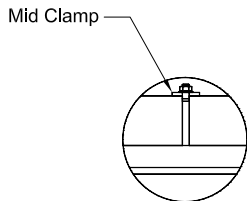

Detail D - Mid Clamp to Rail - Elevation
6" = 1' -0"

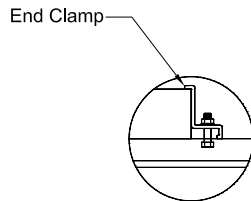

Detail E - End Clamp to Rail - Elev.
6" = 1' -0"

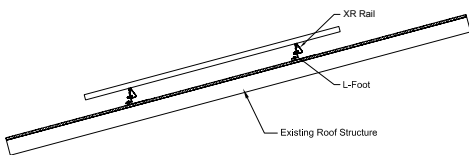

Section - Flush Mount - Sloped Roof
3/4" = 1' -0"

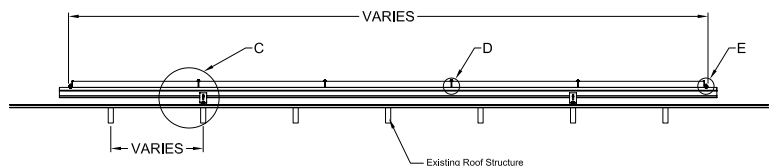

Typical Flush Mount Array - Elevation
3/4" = 1' -0"

XR1000 Rail

XR1000 is a heavyweight among solar mounting rails, built to handle extreme climates and spans 12 feet or more for commercial applications.

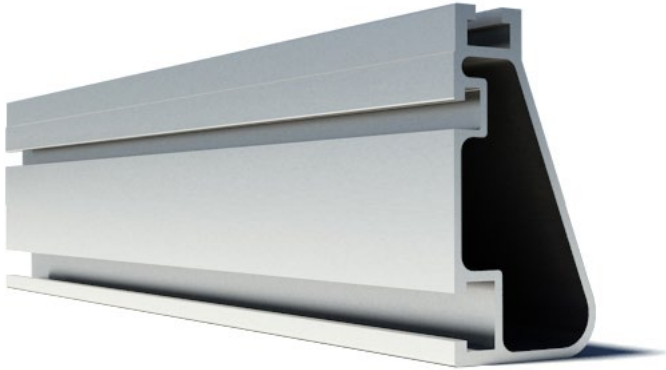

Property	Value
Material	6000 Series Aluminum
Finish	Clear Anodized
Beam Height	3.00"
Weight / Linear Foot	0.945 Lbs
Total Cross-Sectional Area	0.807 In ²
Section Modulus (X-axis)	0.530 In ³
Moment of Inertia (X-axis)	0.843 In ⁴
Moment of Inertia (Y-axis)	0.182 In ⁴
Torsional Constant	0.436 In ³
Polar Moment of Inertia	0.3299 In ⁴

XR100 Rail

XR100 is the ultimate residential mounting rail. It supports a range of wind and snow conditions, while also maximizing spans.



Property	Value
Material	6000 Series Aluminum
Finish	Clear & Black Anodized
Beam Height	2.44"
Weight / Linear Foot	0.68 Lbs
Total Cross-Sectional Area	0.582 In ²
Section Modulus (X-axis)	0.297 In ³
Moment of Inertia (X-axis)	0.390 In ⁴
Moment of Inertia (Y-axis)	0.085 In ⁴
Torsional Constant	0.214 In ³
Polar Moment of Inertia	0.126 In ⁴

XR10 Rail

XR10 is a low-profile mounting rail, perfectly matched to regions with light snow. It achieves 6 foot spans, while staying light and economical.



Property	Value
Material	6000 Series Aluminum
Finish	Clear Anodized
Beam Height	1.75"
Weight / Linear Foot	0.436 Lbs
Total Cross-Sectional Area	0.363 In ²
Section Modulus (X-axis)	0.136 In ³
Moment of Inertia (X-axis)	0.124 In ⁴
Moment of Inertia (Y-axis)	0.032 In ⁴
Torsional Constant	0.076 In ³
Polar Moment of Inertia	0.033 In ⁴

Internal Splice

IronRidge Rails are easy to extend with our patent-pending Internal Splices.

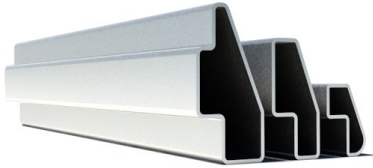

Property	Value
Material	6000 Series Aluminum
Finish	Mill
Length	12"
Hardware	2 SS Self-tapping Screws

End Clamp

IronRidge End Clamps secure PV modules to XR Rails using the top slot, independent upon the module's mounting holes.



Property	Value
Material	5000 & 6000 Series Aluminum
Finish	Mill & Black
Height	Varies depending on Module
Width	1.5"
Depth	1.5"
Weight	0.2 Lbs
Hardware	1/4"-20 SS Nut and Bolt

Mid Clamp

IronRidge Mid Clamps secure PV modules to the rail when there are multiple modules in a row.



Property	Value
Material	5000 Series Aluminum
Finish	Mill & Black
Spacing between Modules	1/4"
Width	1"
Depth	1.5"
Weight	0.2 Lbs
Hardware	1/4"-20 SS Nut and Bolt

Grounding Mid Clamp

Grounding Mid Clamps pierce through anodized coatings to ground array, being ETL listed to UL 2703.



Property	Value
Material	304 Stainless Steel
Finish	Mill & Black
Spacing between Modules	1/4"
Width	1"
Depth	1.2"
Weight	0.3 Lbs
Hardware	1/4"-20 SS Nut and Bolt

Slotted L-Foot

Our Slotted L-feet are engineered for most roof mounting applications. Vertical slots allow for easily dropping in rails with attached hardware and provide adjustability to account for roof irregularities.

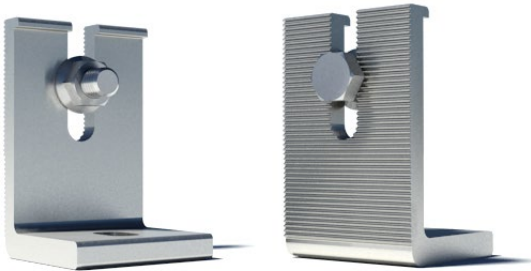

Property	Value
Material	6000 Series Aluminum
Finish	Mill & Black
Height	3"
Width	2"
Depth	2"
Length of Vertical Slot	1.125"
Weight	0.16 Lbs
Hardware	3/8" SS

FlashFoot™

IronRidge FlashFoot™ is an all-in-one solar mounting product for composition shingle roofs that eliminates the need for separate standoffs, flashings, and L-feet. FlashFoot incorporates a number of structural and waterproofing features to securely attach IronRidge Rails to roof structures, while also protecting against water intrusion and weather damage. Comes with flashing, lag bolt, and L-Foot.



Property	Value
Material	Aluminum
Finish	Mill & Black
Height	3.5"
Length	12"
Width	12"
Dual Mechanical Seal	Yes
Open L-Foot Slot	Yes
Weight	1.35 Lbs
Hardware	5/16" and 3/8" SS

Under Clamp

IronRidge Under Clamps secure PV modules to the XR1000 Rail using the mounting holes of the PV module and the side slot of the rail.



Property	Value
Material	6000 Series Aluminum
Finish	Mill
Spacing between Modules	1/4"
Width	1.6"
Depth	1.5"
Weight	0.05 Lbs
Hardware	1/4"-20 SS Nut and Bolt

Flush Mount Standoff

Our Flush Mount Aluminum Standoffs are sized to integrate easily with Oatey Flashings. IronRidge Flush Mount Standoffs are available in four lengths ranging from 3" to 7". Standoffs include L-Foot mounting hardware. Lag bolts not included.



Property	Value
Material (Post)	6000 Series Aluminum
Material (Base)	5000 Series Aluminum
Finish	Mill
Heights	3", 4", 6", 7"
Post Diameter	1.5"
Depth	4"
Weight	0.84 Lbs
Hardware	5/16"

Tilt Mount Standoff

Our Tilt Mount Aluminum Standoffs are sized to integrate easily with Oatey Flashings. IronRidge Tilt Mount Standoffs are available in four lengths ranging from 3.75" to 9". They ship pre-assembled, and include L-Foot Mounting hardware. Lag bolts included.



Property	Value
Material (Post)	6000 Series Aluminum
Material (Base)	A360 (Cast AL)
Finish	Mill
Heights	3.75", 6", 9"
Post Diameter	1.25"
Base Diameter	4"
Weight	0.85 Lbs
Hardware	5/16" SS L-Foot & Lag Bolts

Fixed Tilt Length Leg

Our Fixed Tilt Legs attach directly to IronRidge XR Rails. This simple design provides adjustability in all 3 axes, and a variety of lengths cover most angles. Each Tilt Leg Kit comes with the shorter front leg, the longer rear leg, mounting brackets and hardware.



Property	Value
Material (Legs)	6000 Series Aluminum
Material (Brackets)	5000 Series Aluminum
Finish	Mill
Length (Short Leg)	6"
Length (Long Legs)	10", 15", 20", 25", 30", 40"
Leg Diameter	1.5" Square Tube
Tube Weight / Linear Foot	0.80 Lbs
Height (Brackets)	2.6"
Width (Brackets)	1.85"
Depth (Brackets)	2"
Hardware	3/8" SS

Adjustable Tilt Length Leg

As with our Fixed Tilt Legs, the Adjustable Tilt Legs attach directly to IronRidge XR Rails. Each Tilt Leg Assembly kit comes with the shorter fixed front leg, the longer adjustable rear leg, and all the necessary hardware.

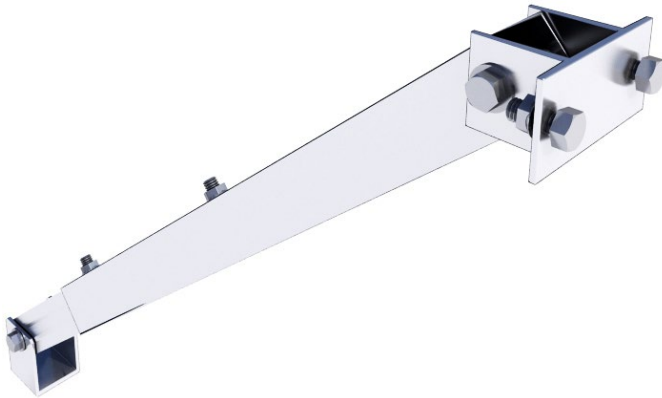

Property	Value
Material (Legs)	6000 Series Aluminum
Material (Brackets)	5000 Series Aluminum
Finish	Mill
Length (Short Leg)	6"
16" Range (Long Leg)	18" – 22"
28" Range (Long Leg)	30" – 46"
56" Range (Long Leg)	58" – 94"
Outer Tube Diameter	1.8" Square Tube
Inner Tube Diameter	1.5" Square Tube
Upper Bracket	2.2"x4.25"x2"
Lower Bracket	2.6"x1.85"x2"
Hardware	3/8" SS

Grounding Strap

Grounding Straps are used to bond rail-to-rail connections. They are only required on the rail with the grounding lug. Grounding Strap Expansion Joint also available.



Property	Value
Material	Tin-plated Copper Flat Braid
Weight	0.054 Lbs
Wire Gauge	9 AWG

End Caps

End caps provide a finished look while protecting against the collection of water and debris inside the rail.



Property	Value
Material	Polycarbonate
Color	Black
UV Protection	Yes

Wire Clips

IronRidge Wire Clips snap into the top slot of XR Rails, and accommodate up to ten 5mm panel wires, or one MC4, one Enphase wire and one dual Enphase wire. The Wire Clips are molded from black polycarbonate with UV protection.



Property	Value
Material	Polycarbonate
Color	Black
UV Protection	Yes
Weight	0.01 Lbs

Microinverter Mounting Kit

Mount either one or two microinverters, depending on model.



Property	Value
Material	Stainless Steel
Color	Mill
Hardware	1/4 x 3/4" Hex or T-Bolts
Weight	0.06 Lbs

Grounding Lug

Manufactured from high strength copper alloy with stainless steel screw, UL listed and CSA certified. Hex bolt and grounding T-bolt versions available. Hex bolt version not compatible with XR10 or XR100 rails.

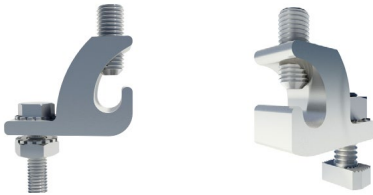

Property	Value
Material	SS & Tin-plated Copper
Weight	0.154 Lbs
Conductor Size	4-14 AWG
Listing	UL 467 Compliant
Hardware	#10 & 1/4" SS

Third-Party Grounding Components

Wiley grounding clips (WEEB DMC) are used in conjunction with the IronRidge Mid Clamps for grounding PV modules to rails.



Property	Value
Material	304 Stainless Steel
ETL Listed	ANSI/UL 467 Compliant
Maximum Conductor Size	6 AWG (with two WEEBs contacting each module)
Hardware	None

Wiley grounding lugs are used in conjunction with copper wire to provide a continuous ground for every row of rails.



Property	Value
WEEB Material	304 Stainless Steel
Lug Material	Tin-plated Copper
ETL Listed	ANSI/UL 467 Compliant
Ground Conductor	One 14 AWG to 6 AWG or two 10 AWG, two 12 AWG
Hardware	1/4"-20 & 1/4"-28 SS

Wiley bonding jumpers are used to provide a continuous ground between spliced rail sections. Order one jumper for every splice.



Property	Value
WEEB Material	304 Stainless Steel
Braid Material	Tin-plated Copper
ETL Listed	ANSI/UL 467 Compliant
Hardware	1/4"-20 SS

Summary

With the IronRidge Design Assistant™ our customers move from laboriously designing systems across the span of weeks, to intuitively designing while pricing, a bill of materials and engineering calculations all updates in real-time.

If you choose to register for an online account, you will then be able to save your work and prevent losing your project's configuration settings.

The application is so quick and easy to use, multiple what-if scenarios can be evaluated through immediate engineering and pricing feedback. Engineered calculations comply with ASCE 7-10 building codes for expedited P.E. approval.

The IronRidge Design Assistant™ is provided free of charge to IronRidge customers.

Design, engineer and quote, online, in just minutes.

ironridge.com/support/designassistant



Code Compliance

IronRidge Roof Mount components, when installed in accordance with the IronRidge Roof Mount Installation Manual, will be structurally adequate and will meet the structural requirements of:

- ASCE/SEI 7-10 Min. Design Loads for Buildings & Other Structures
- California Building Code 2013 Edition
- AC428, Acceptance Criteria for Modular Framing Systems Used to Support PV Modules, Effective November 1, 2012 (ICC-ES)
- Aluminum Design Manual, 2010 Edition
- Florida Building Code 2010 Edition
- Florida Residential Building Code 2010 Edition
- International Building Code 2012 Edition
- International Residential Building Code 2012 Edition

IronRidge Rails with Integrated Grounding conforms to:

- UL Subject 2703 Outline of Investigation for Rack Mounting Systems and Clamping Devices for Flat-Plate Photovoltaic Modules and Panels
- ETL Listed requirements and certification

Thermal Expansion (Expansion Joints)

For rows exceeding 100 feet of rail, a Grounding Strap Expansion Joint is required for thermal expansion. Insert Internal Splice into first rail and secure with screw. Assemble and secure Expansion Joint an inch from rail end. Slide second rail over Internal Splice, attach other end of Expansion Joint with hardware, and secure with screw. Torque screws and nuts to 84 in-lbs.

AWC Lag Pull-out Chart

Lag pull-out (withdrawal) capacities (lbs) in typical roof lumber (ASD)

Material	Specific Gravity	Lag Screw Specifications*
Douglas Fir, Larch	0.50	266
Douglas Fir, South	0.46	235
Engelmann Spruce, Lodgepole Pine (MSR 1650 f & higher)	0.46	235
Hem, Fir, Redwood (close grain)	0.43	212
Hem, Fir (North)	0.46	235
Southern Pine	0.55	307
Spruce, Pine, Fir	0.42	205
Spruce Pine Fir (E of 2 million psi and higher grades of MSR and MEL)	0.50	266

Sources: American Wood Council, NDS 2005, Table 11.2A, 11.3.2A.

- Notes: (1) Thread must be embedded in the side grain of a rafter or other structural member integral with the building structure.
 (2) Lag bolts must be located in the middle third of the structural member.
 (3) These values are not valid for wet services.
 (4) This table does not include shear capacities. If necessary, contact a local engineer to specify lag bolt size with regard to shear forces.
 (5) Install lag bolts with head and washer flush to surface (no gap). Do not over-torque.
 (6) Withdrawal design values for lag screw connections shall be multiplied by applicable adjustment factors if necessary. See Table 10.3.1 in the American Wood Council NDS for Wood Construction.

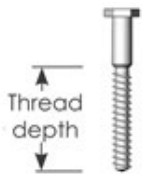

*5/16" shaft, per inch thread depth (Use flat washers with lag screws).

Rails & Splices

When top mounting panels, the lengths of XR Rails required for each row may be determined by multiplying the quantity of modules in a row by the module's width. Add to this ¼ inch space between each module and 1.5 inches to each end for the total length of rail required for that row.

XR Rails

Part Number	Description	Weight	Packaging
XR-1000-132A	XR1000, Rail 132" (11 Feet), Clear	11.24 Lbs	Sub-bundles of 4; Bundles of 80
XR-1000-168A	XR1000, Rail 168" (14 Feet), Clear	14.30 Lbs	Sub-bundles of 4; Bundles of 80
XR-1000-204A	XR1000, Rail 204" (17 Feet), Clear	17.36 Lbs	Sub-bundles of 4; Bundles of 80
XR-100-132A	XR100, Rail 132" (11 Feet), Clear	7.69 Lbs	Sub-bundles of 4; Bundles of 80
XR-100-132B	XR100, Rail 132" (11 Feet), Black	7.69 Lbs	Sub-bundles of 4; Bundles of 80
XR-100-168A	XR100, Rail 168" (14 Feet), Clear	9.76 Lbs	Sub-bundles of 4; Bundles of 80
XR-100-168B	XR100, Rail 168" (14 Feet), Black	9.76 Lbs	Sub-bundles of 4; Bundles of 80
XR-100-204A	XR100, Rail 204" (17 Feet), Clear	11.88 Lbs	Sub-bundles of 4; Bundles of 80
XR-100-204B	XR100, Rail 204" (17 Feet), Black	11.88 Lbs	Sub-bundles of 4; Bundles of 80
XR-10-132A	XR10, Rail 132" (11 Feet), Clear	4.80 Lbs	Sub-bundles of 4; Bundles of 160
XR-10-168A	XR10, Rail 168" (14 Feet), Clear	6.11 Lbs	Sub-bundles of 4; Bundles of 160
XR-10-204A	XR10, Rail 204" (17 Feet), Clear	7.41 Lbs	Sub-bundles of 4; Bundles of 160

Internal Splices

Part Number	Description	Weight	Packaging
XR-1000-SPLC	XR1000 Splice	0.55 Lbs	1 Splice/Kit; 20 Splices/Box
XR-100-SPLC	XR100 Splice	0.54 Lbs	1 Splice/Kit; 20 Splices/Box
XR-10-SPLC	XR10 Splice	0.53 Lbs	1 Splice/Kit; 20 Splices/Box

Clamps

Module Clamp size depends on the module thickness. Use the table below to determine which Module Clamp will fit your projects module thickness.

Module Thickness		Clamp Info		Part Numbers			
Mm	Inches	Type	Bolt Height	End Clamp	Hex Mid Clamp	T-bolt Mid Clamp	Grounding Mid Clamp
31.0 - 32.5	1.22 - 1.28	I	2.00"	29-7000-125	29-7000-105	29-70TB-105	RS-GD-MCL-200
32.5 - 33.5	1.28 - 1.32	L	2.00"	29-7000-130	29-7000-105	29-70TB-105	RS-GD-MCL-200
33.3 - 34.8	1.31 - 1.37	A	2.00"	29-7000-134	29-7000-105	29-70TB-105	RS-GD-MCL-200
34.8 - 36.8	1.37 - 1.45	B	2.00"	29-7000-224	29-7000-105	29-70TB-105	RS-GD-MCL-225
39.0 - 41.0	1.53 - 1.61	C	2.25"	29-7000-157	29-7000-101	29-70TB-101	RS-GD-MCL-225
41.1 - 42.7	1.62 - 1.68	J	2.25"	29-7000-165	29-7000-101	29-70TB-101	RS-GD-MCL-250
42.7 - 44.2	1.68 - 1.74	E	2.25"	29-7000-171	29-7000-101	29-70TB-101	RS-GD-MCL-250
45.0 - 47.0	1.77 - 1.85	F	2.50"	29-7000-214	29-7000-108	29-70TB-108	RS-GD-MCL-250
46.7 - 48.3	1.84 - 1.90	K	2.50"	29-7000-187	29-7000-108	29-70TB-108	RS-GD-MCL-275
49.0 - 51.1	1.93 - 2.01	G	2.50"	29-7000-204	29-7000-108	29-70TB-108	RS-GD-MCL-275
57.4 - 58.9	2.26 - 2.32	H	2.75"	29-7000-230	29-7000-104	29-70TB-104	Unsupported

End Clamps

Part Number	Description	Weight	Packaging
29-7000-125	Kit, 4pcs, End Clamp I, 1.25", Mill	0.3 Lbs	Kits of 4; Boxes of 25
29-7000-130	Kit, 4pcs, End Clamp I, 1.30", Mill	0.3 Lbs	Kits of 4; Boxes of 25
29-7000-134	Kit, 4pcs, End Clamp A, 1.34", Mill	0.3 Lbs	Kits of 4; Boxes of 25
29-7000-224	Kit, 4pcs, End Clamp B, 1.41", Mill	0.3 Lbs	Kits of 4; Boxes of 25
29-7000-157	Kit, 4pcs, End Clamp C, 1.57", Mill	0.3 Lbs	Kits of 4; Boxes of 25
29-7000-165	Kit, 4pcs, End Clamp J, 1.65", Mill	0.3 Lbs	Kits of 4; Boxes of 25
29-7000-171	Kit, 4pcs, End Clamp E, 1.71", Mill	0.3 Lbs	Kits of 4; Boxes of 25
29-7000-214	Kit, 4pcs, End Clamp F, 1.81", Mill	0.3 Lbs	Kits of 4; Boxes of 25
29-7000-187	Kit, 4pcs, End Clamp K, 1.87", Mill	0.3 Lbs	Kits of 4; Boxes of 25
29-7000-204	Kit, 4pcs, End Clamp G, 1.97", Mill	0.3 Lbs	Kits of 4; Boxes of 25
29-7000-230	Kit, 4pcs, End Clamp H, 2.30", Mill	0.3 Lbs	Kits of 4; Boxes of 25
29-7000-125B	Kit, 4pcs, End Clamp I, 1.25" Black	0.3 Lbs	Kits of 4; Boxes of 25
29-7000-130B	Kit, 4pcs, End Clamp I, 1.30", Black	0.3 Lbs	Kits of 4; Boxes of 25
29-7000-134B	Kit, 4pcs, End Clamp A, 1.34" Black	0.3 Lbs	Kits of 4; Boxes of 25
29-7000-224B	Kit, 4pcs, End Clamp B, 1.41" Black	0.3 Lbs	Kits of 4; Boxes of 25
29-7000-157B	Kit, 4pcs, End Clamp C, 1.57" Black	0.3 Lbs	Kits of 4; Boxes of 25
29-7000-165B	Kit, 4pcs, End Clamp J, 1.65" Black	0.3 Lbs	Kits of 4; Boxes of 25
29-7000-171B	Kit, 4pcs, End Clamp E, 1.71" Black	0.3 Lbs	Kits of 4; Boxes of 25
29-7000-214B	Kit, 4pcs, End Clamp F, 1.81" Black	0.3 Lbs	Kits of 4; Boxes of 25
29-7000-187B	Kit, 4pcs, End Clamp K, 1.87" Black	0.3 Lbs	Kits of 4; Boxes of 25
29-7000-204B	Kit, 4pcs, End Clamp G, 1.97" Black	0.3 Lbs	Kits of 4; Boxes of 25

Mid Clamps

Part Number	Description	Weight	Packaging
29-7000-105	Kit, 4pcs, Mid Clamp A/B/I, 2.00", Mill (Hex)	0.3 Lbs	Kits of 4; Boxes of 50
29-7000-101	Kit, 4pcs, Mid Clamp C/D/J/E, 2.25", Mill (Hex)	0.3 Lbs	Kits of 4; Boxes of 50
29-7000-108	Kit, 4pcs, Mid Clamp F/K/G, 2.50", Mill (Hex)	0.3 Lbs	Kits of 4; Boxes of 50
29-7000-104	Kit, 4pcs, Mid Clamp H 2.75", Mill (Hex)	0.3 Lbs	Kits of 4; Boxes of 50
29-70TB-105	Kit, 4pcs, Mid Clamp A/B/I, 2.00", Mill (T-bolt)	0.3 Lbs	Kits of 4; Boxes of 50
29-70TB-101	Kit, 4pcs, Mid Clamp C/D/J/E, 2.25", Mill (T-bolt)	0.3 Lbs	Kits of 4; Boxes of 50
29-70TB-108	Kit, 4pcs, Mid Clamp F/K/G, 2.50", Mill (T-bolt)	0.3 Lbs	Kits of 4; Boxes of 50
29-70TB-104	Kit, 4pcs, Mid Clamp H, 2.75", Mill (T-bolt)	0.3 Lbs	Kits of 4; Boxes of 50
29-7000-105B	Kit, 4pcs, Mid Clamp A/B/I, 2.0", Black (Hex)	0.3 Lbs	Kits of 4; Boxes of 50
29-7000-101B	Kit, 4pcs, Mid Clamp C/D/J/E, 2.25", Black (Hex)	0.3 Lbs	Kits of 4; Boxes of 50
29-7000-108B	Kit, 4pcs, Mid Clamp F/K/G, 2.5", Black (Hex)	0.3 Lbs	Kits of 4; Boxes of 50
29-7000-104B	Kit, 4pcs, Mid Clamp H, 2.75", Black (Hex)	0.3 Lbs	Kits of 4; Boxes of 50
29-70TB-105B	Kit, 4pcs, Mid Clamp A/B/I, 2.00", lack (T-bolt)	0.3 Lbs	Kits of 4; Boxes of 50
29-70TB-101B	Kit, 4pcs, Mid Clamp C/D/J/E, 2.25", Black (T-bolt)	0.3 Lbs	Kits of 4; Boxes of 50
29-70TB-108B	Kit, 4pcs, Mid Clamp F/K/G, 2.50", Black (T-bolt)	0.3 Lbs	Kits of 4; Boxes of 50
29-70TB-104B	Kit, 4pcs, Mid Clamp H, 2.75", Black (T-bolt)	0.3 Lbs	Kits of 4; Boxes of 50

Grounding Mid Clamps

Part Number	Description	Weight	Packaging
RS-GD-MCL-200	Kit, 4pcs, Mid Clamp A/B/I, 2.00", Mill (T-bolt)	0.3 Lbs	Kits of 4; Boxes of 50
RS-GD-MCL-225	Kit, 4pcs, Mid Clamp C/D/J/E, 2.25", Mill (T-bolt)	0.3 Lbs	Kits of 4; Boxes of 50
RS-GD-MCL-250	Kit, 4pcs, Mid Clamp F/K/G, 2.50", Mill (T-bolt)	0.3 Lbs	Kits of 4; Boxes of 50
RS-GD-MCL-275	Kit, 4pcs, Mid Clamp H 2.75", Mill (T-bolt)	0.3 Lbs	Kits of 4; Boxes of 50
RS-GD-MCL-200B	Kit, 4pcs, Mid Clamp A/B/I, 2.00", Black (T-bolt)	0.3 Lbs	Kits of 4; Boxes of 50
RS-GD-MCL-225B	Kit, 4pcs, Mid Clamp C/D/J/E, 2.25", Black (T-bolt)	0.3 Lbs	Kits of 4; Boxes of 50
RS-GD-MCL-250B	Kit, 4pcs, Mid Clamp F/K/G, 2.50", Black (T-bolt)	0.3 Lbs	Kits of 4; Boxes of 50
RS-GD-MCL-275B	Kit, 4pcs, Mid Clamp H, 2.75", Black (T-bolt)	0.3 Lbs	Kits of 4; Boxes of 50

Under Clamps

Part Number	Description	Weight	Packaging
29-7000-117	Kit, 4pcs, Under Clamp	0.4 Lbs	Kits of 4; Boxes of 25

Attachments
Slotted L-Feet

Part Number	Description	Weight	Packaging
RS-LFT-001	4-pack, Slotted L-Foot, Mill	1.14 Lbs	4 L-feet/Pack; 25 Kits/Box
RS-LFT-001B	4-pack, Slotted L-Foot, Black	1.14 Lbs	4 L-feet/Pack; 25 Kits/Box

FlashFoot™

Part Number	Description	Weight	Packaging
RF-FLSH-001	Kit, 6-pack, IronRidge FlashFoot (Mill) (L-foot Included)	8.1 Lbs	6 Flashings/Box
RF-FLSH-001B	Kit, 6-pack, IronRidge FlashFoot (Black) (L-foot Included)	8.1 Lbs	6 Flashings/Box

Flush Mount Standoffs

Part Number	Description	Weight	Packaging
51-6003-500L	Kit, 3" Standoff, Flush Mount, Mill	0.51 Lbs	20 Standoffs / Box
51-6004-500L	Kit, 4" Standoff, Flush Mount, Mill	0.56 Lbs	20 Standoffs / Box
51-6006-500L	Kit, 6" Standoff, Flush Mount, Mill	0.75 Lbs	20 Standoffs / Box
51-6007-500L	Kit, 7" Standoff, Flush Mount, Mill	0.84 Lbs	20 Standoffs / Box

Tilt Mount Standoffs

Part Number	Description	Weight	Packaging
RF-TLT-SO-375	Kit, Quick Mount PV, Low Slope Mount 3.75"	1.34 Lbs	12 Standoffs / Box
RF-TLT-SO-700	Kit, Quick Mount PV, Low Slope Mount 7.00"	1.63 Lbs	12 Standoffs / Box
RF-TLT-SO-900	Kit, Quick Mount PV, Low Slope Mount 9.00"	2.10 Lbs	12 Standoffs / Box

Adjustable Tilt Legs

Part Number	Description	Weight	Packaging
51-7516-016H	Adjustable Tilt Leg, 16 inches (18-22")	4.29 Lbs	12 Adjustable Tilt Legs/Box
51-7528-028H	Adjustable Tilt Leg, 28 inches (30-46")	6.34 Lbs	12 Adjustable Tilt Legs/Box
51-7556-056H	Adjustable Tilt Leg, 56 inches (58-94")	10.39 Lbs	12 Adjustable Tilt Legs/Box

Fixed Tilt Legs

Part Number	Description	Weight	Packaging
51-7210-010	Tilt Leg Kit, 10", Mill	1.87 Lbs	20 Fixed Tilt Legs/Box
51-7215-015	Tilt Leg Kit, 15", Mill	2.20 Lbs	20 Fixed Tilt Legs/Box
51-7220-020	Tilt Leg Kit, 20", Mill	2.56 Lbs	20 Fixed Tilt Legs/Box
51-7225-025	Tilt Leg Kit, 25", Mill	2.85 Lbs	20 Fixed Tilt Legs/Box
51-7230-030	Tilt Leg Kit, 30", Mill	3.20 Lbs	20 Fixed Tilt Legs/Box
51-7240-040	Tilt Leg Kit, 40", Mill	3.85 Lbs	20 Fixed Tilt Legs/Box

Accessories

Part Number	Description	Weight	Packaging
XR-1000-CAP	XR1000 End Cap (Polybag, 20)	7 Lbs/Box	20 End Caps/ Bag; 500 Caps / Box
XR-100-CAP	XR100 End Cap (Polybag, 20)	5 Lbs/Box	20 End Caps/ Bag; 500 Caps / Box
XR-10-CAP	XR10 End Cap (Polybag, 20)	4 Lbs/Box	20 End Caps/ Bag; 500 Caps / Box
29-4000-077	Wire Clip (Polybag, 20)	6.70 Lbs/Box	20 Clips / Bag; 500 Clips / Box
29-5003-005	Kit, ¼ x ¾ Microinverter Mounting	10.30 Lbs/Box	150 Kits / Box
29-50TB-005	Kit, ¼ x ¾ Microinverter Mounting, T-Bolt	10.30 Lbs/Box	150 Kits / Box

Grounding

Part Number	Description	Weight	Packaging
RS-GDST-001	Grounding Strap	2.7 Lbs/Box	50 Kits / Box
RS-GDXP-001	Grounding Strap Expansion Joint	2.0 Lbs/Box	25 Kits / Box
RS-GDLG-001	Grounding Lug (XR1000 Compatible Only)	7.7 Lbs/Box	50 Kits / Box
RS-GDLG-002	Grounding Lug (T-Bolt)	7.9 Lbs/Box	50 Kits / Box
29-4000-001	WEEB DMC Compression Clip	.50 Lbs/Box	100 Clips / Box
29-4000-002	WEEB Grounding Lug	12.45 Lbs/Box	100 Lugs / Box
29-4000-003	WEEB Bonding Jumper	17.55 Lbs/Box	100 Jumpers / Box

System Support

IronRidge provides a complete system of technical support including installation guides, pre-stamped certification letters for most PV-friendly states, our online Design Assistant software, and live, knowledgeable person-to-person customer service.

Downloadable Support Documents

Our website at www.ironridge.com/products/roofmounting/systemsupport contains all of the technical support information necessary to design, quote, certify, and install an IronRidge Roof Mount system. The specific documents that can be found here include:

- CAD files (AutoCAD format)
- Engineering Design Guide
- Pre-stamped Certification Letters
- Installation Guides
- Parts Catalog

3rd Party Partners

We've engineered best-of-class 3rd party solutions with our Roof Mount platform to further improve the quality we offer customers. Where appropriate, pre-stamped certification letters are included to simplify and expedite the design, quoting, and permitting processes. At this time, we work with roofing products from the following companies:

- Ecofasten
- Enphase
- Quick Mount PV
- S5!
- Wiley

Design Assistant

The IronRidge Design Assistant automates much of the Design and Engineering phases of a project. Easily accessible from our website, the Design Assistant provides a highly intuitive layout interface, automatically calculates critical engineering information based on your project's specific load conditions, provides the ability to add optional components and 3rd party products, and determines an accurate bill of materials and quotations.

The Roof Mount Design Assistant can be accessed at: www.ironridge.com/rm

Engineering Services

IronRidge provides expedited site specific certification letters for many standard load conditions. These letters are available in most PV-friendly states, including:

Arizona	North Carolina
California	New Hampshire
Colorado	New Jersey
Connecticut	New Mexico
D.C.	Nevada
Delaware	New York
Florida	Ohio
Georgia	Oklahoma
Hawaii	Oregon
Iowa	Pennsylvania
Illinois	Rhode Island
Indiana	South Carolina
Louisiana	Tennessee
Massachusetts	Texas
Maryland	Utah
Michigan	Virginia
Maine	Vermont
Minnesota	Washington
Missouri	

In addition, we provide pre-stamped certification letters for:

Ontario
New Zealand
Puerto Rico

We can also provide non-standard certifications, wet-stamped letters, or specialized engineering requests. Our preferred engineering firm is Starling Madison Lofquist, Inc. Their contact information is:

Starling Madison Lofquist, Inc.
5224 South 39th Street
Phoenix, Arizona 85040
Phone: 602-438-2500

Customer Service

The IronRidge support staff is knowledgeable, experienced, friendly, and responsive. We would be happy to provide assistance on any questions you may have. Please feel free to contact us through your preferred method at:

Email: support@ironridge.com
Phone: 800-227-9523

Warranty Information

Effective for IronRidge, Inc. ("IronRidge") mounting structure components ("Products") manufactured after April 1st, 2012, IronRidge provides the following warranties, for Products installed properly and used for the purpose for which the Products are designed:

- finishes shall be free of visible defects, peeling, or cracking, under normal atmospheric conditions, for a period of three (3) years from the earlier of (i) the date of complete installation of the Product or (ii) thirty days after the original purchaser's date of purchase of the Product ("Finish Warranty");
- components shall be free of structurally-related defects in materials for a period of ten (10) years from the earlier of (i) the date of complete installation of the Product or (ii) thirty days after the original purchaser's date of purchase of the Product;
- components shall be free of functionally-related manufacturing defects for a period of twenty (20) years from date of manufacture.

The Finish Warranty does not apply to: (a) surface oxidation of the galvanized steel components or any foreign residue deposited on Product finish; and (b) Products installed in corrosive atmospheric conditions, as defined solely by IronRidge; corrosive atmospheric conditions include, but are not limited to, conditions where Product is exposed to corrosive chemicals, fumes, cement dust, salt water marine environments or to continual spraying of either salt or fresh water. The Finish Warranty is VOID if (c) the practices specified by AAMA 609 & 610-02 – "Cleaning and Maintenance for Architecturally Finished Aluminum" (www.aamanet.org) are not followed by Purchaser for IronRidge's aluminum based components; and (d) if the practices specified by ASTM A780 / A780M - 09 "Standard Practice for Repair of Damaged and Uncoated Areas of Hot-Dip Galvanized Coatings" are not followed by Purchaser for IronRidge's galvanized steel-based components.

The warranties above do not cover any parts or materials not manufactured by IronRidge, and exclude non-functionally-related defects, as defined solely by IronRidge. The warranties do not cover any defect that has not been reported to IronRidge in writing within twenty (20) days after discovery of such defect.

In the event of breach of or non-compliance with the warranties set forth above, IronRidge's sole obligation and liability, and the sole and exclusive remedy for such breach or non-compliance, shall be correction of defects by repair, replacement, or credit, at IronRidge's sole discretion. Such repair, replacement or credit shall completely satisfy and discharge all of IronRidge's liability with respect to these warranties.

Refurbished Product may be used to repair or replace the defective components. Transportation, installation, labor, or any other costs associated with Product replacement are not covered by these warranties and are not reimbursable. These warranties additionally do not cover (a) normal wear, or damage resulting from misuse, overloading, abuse, improper installation (including failure to follow professional instruction and certification), negligence, or accident, or from force majeure acts including any natural disasters, war or criminal acts; and (b) Products that have been altered, modified or repaired without written authorization from IronRidge or its authorized representative; and (c) Products used in a manner or for a purpose other than that specified by IronRidge. A formal document proving the purchase and the purchase date of the Product is required with any warranty claim.

Except as set forth above, IronRidge sells the Products on an "AS IS" basis, which may not be free of errors or defects, and ALL EXPRESS OR IMPLIED REPRESENTATIONS AND WARRANTIES, INCLUDING ANY WARRANTIES OF MERCHANTABILITY, FITNESS FOR A PARTICULAR PURPOSE, QUALITY, WORKMANLIKE EFFORT, CORRESPONDENCE TO DESCRIPTION, DESIGN, TITLE OR NON-INFRINGEMENT, OR ARISING FROM COURSE OF DEALING, COURSE OF PERFORMANCE OR TRADE PRACTICE, ARE HEREBY DISCLAIMED.